

MİMARİ KATALOG ARCHITECTURAL CATALOGUE

Alüminyum Kapı Pencere ve Giydirme Cephe Sistemleri
Aluminium Window Doors and Facade Systems



COMP 50

MİMARİ KATALOG ARCHITECTURAL CATALOGUE

Alüminyum Kapı Pencere ve Giydirme Cephe Sistemleri
Aluminium Window Doors and Facade Systems

COMP 50

PROFİLLER

PROFILES

14

15

16

17

18

19

20

21

22

23

24

25

26

KOD / CODE	AĞIRLIK (kg/m) / WEIGHT	Jxx cm ⁴	Jyy cm ⁴	L m	
A010634	1,271	10,261	24,261	6	
A011039	1,447	27,917	28,126	6	

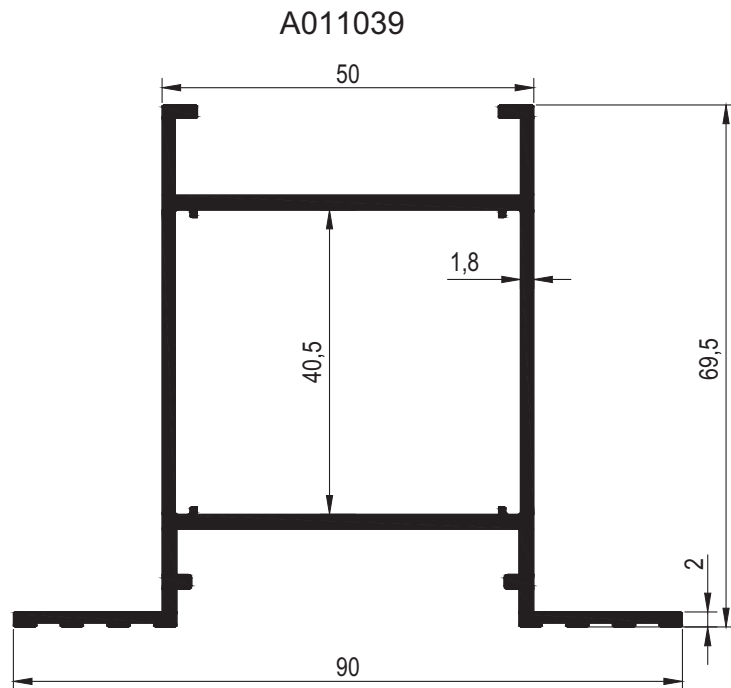
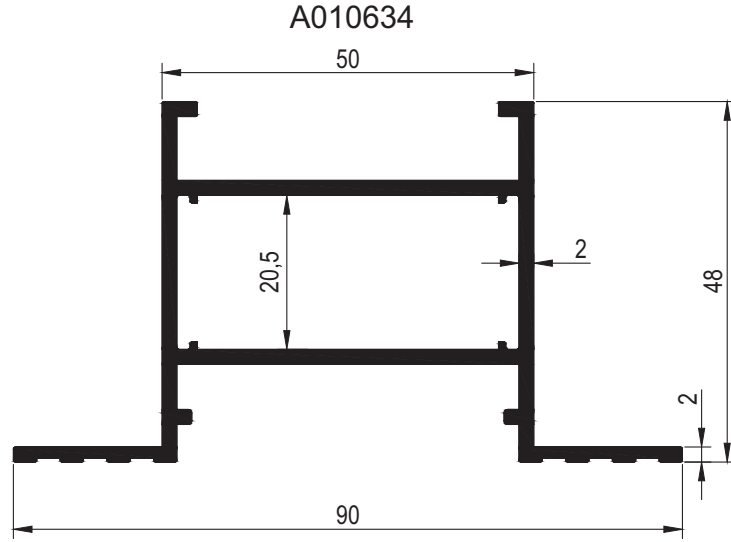

KOD / CODE	AĞIRLIK (kg/m) / WEIGHT	L m	KOD / CODE	AĞIRLIK (kg/m) / WEIGHT	L m
A006531	0,368	6	A003561	0,199	6
A001100	0,224	6	A011191	0,295	6
A003558	0,238	6	A011484	0,168	6
A006773	0,222	6	A011485	0,335	6
A000257	0,335	6			

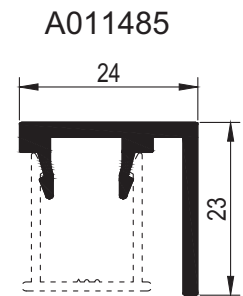
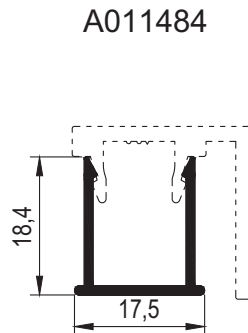
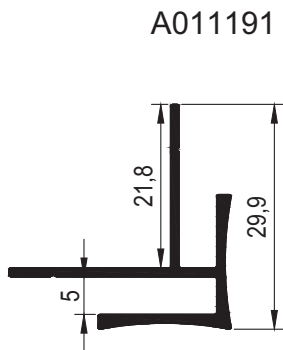
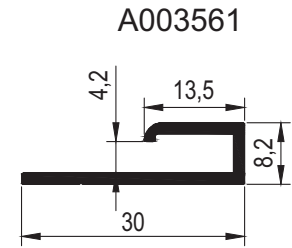
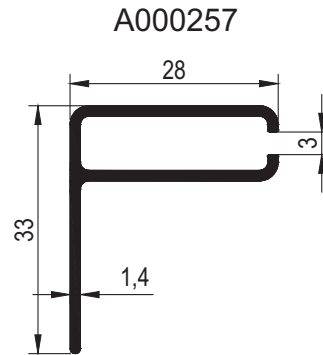
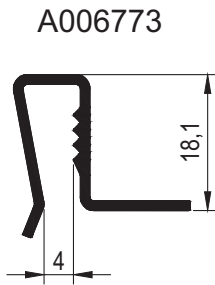
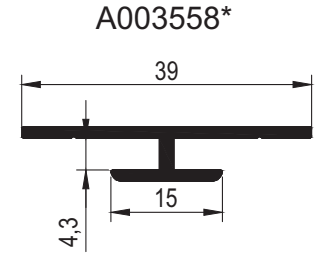
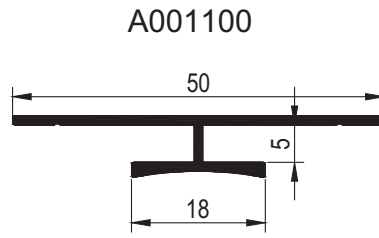
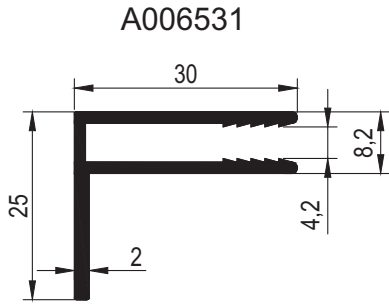
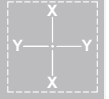

KOD / CODE	AĞIRLIK (kg/m) / WEIGHT	Jxx cm ⁴	Jyy cm ⁴	L m
A011898	0,259	0,096	0,886	6
A011997	0,153	0,059	0,139	6
A015835	0,303	0,609	0,608	6
A015836	0,295	0,444	0,444	6
A015833	0,391	0,169	4,599	6

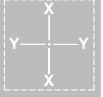

A011898

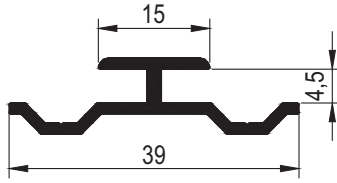

A015833

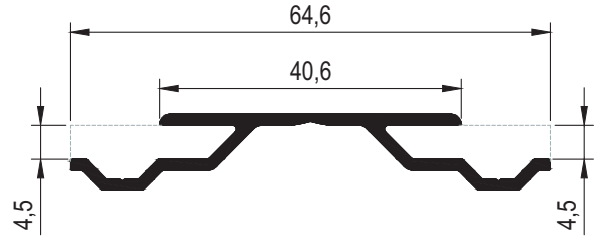

A011997

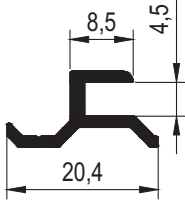

A015835

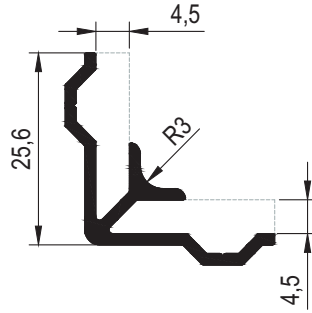

A015836

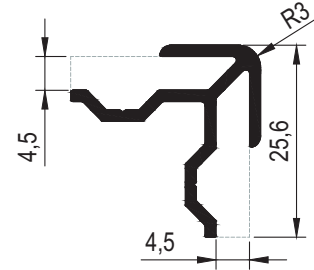

STOKTA BULUNAN SİSTEM PROFİLLERİNİN LİSTESİ
(LIST OF SYSTEM PROFILES IN STOCK)

Nr	MIN. SİPARİŞ MİKTARI MIN. ORDER QUANTITY
A003558	75 kg
A006531	75 kg
A011898	75 kg
A011997	75 kg
A015833	75 kg
A015835	75 kg
A015836	75 kg

* STOKTA BULUNMAYAN TÜM PROFİLLER İÇİN MİNİMUM SİPARİŞ MİKTARI 300 KG'DİR.
MINIMUM ORDER QUANTITY FOR ALL THE PROFILES THAT ARE NOT IN STOCK IS 300 KG.

MİMARİ KATALOG ARCHITECTURAL CATALOGUE

Alüminyum Kapı Pencere ve Giydirme Cephe Sistemleri
Aluminium Window Doors and Facade Systems

COMP 50

DETAYLAR

DETAILS

14

15

16

17

18

19

20

21

22

23

24

25

26

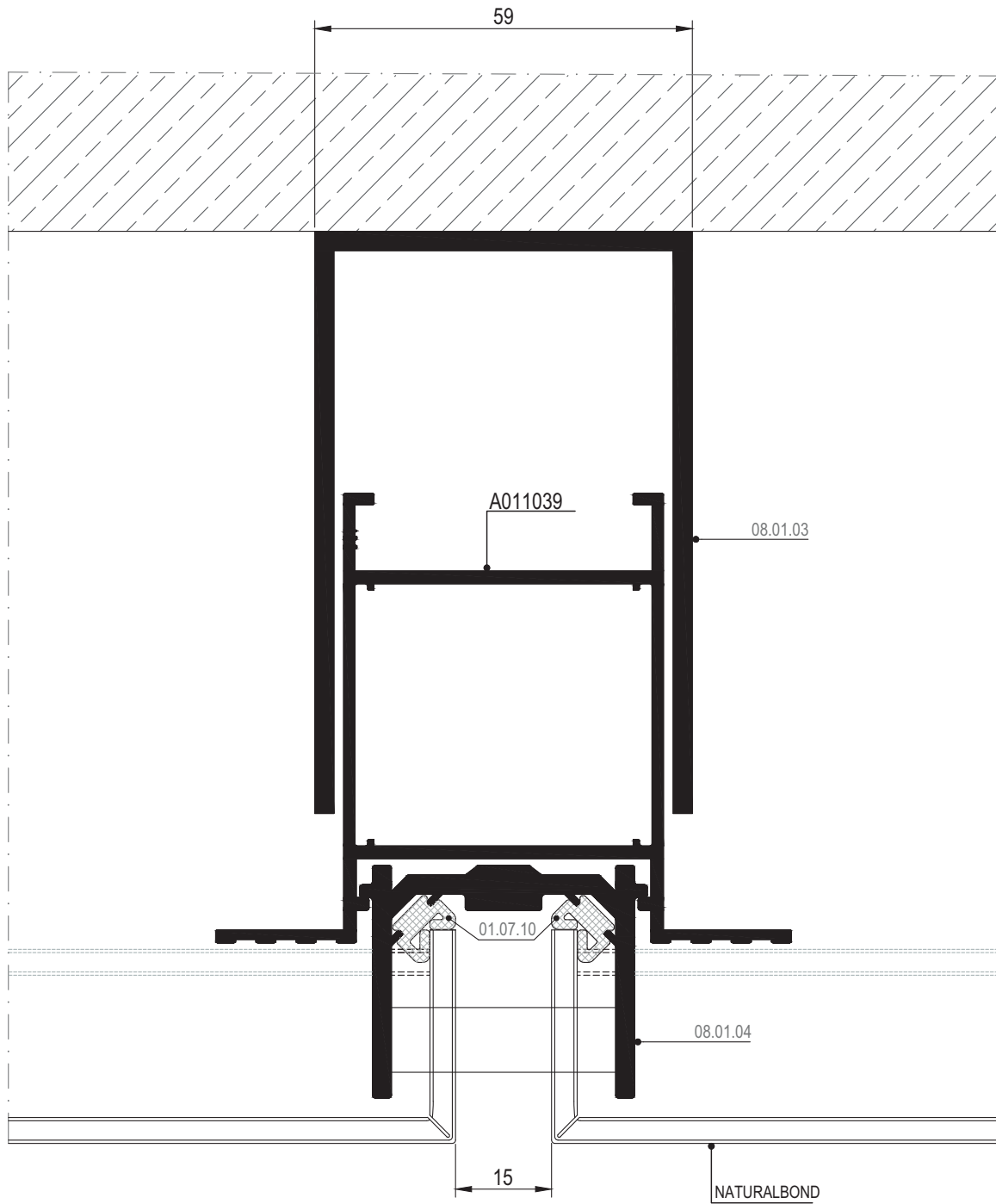

MİMARİ KATALOG ARCHITECTURAL CATALOGUE

Alüminyum Kapı Pencere ve Giydirme Cephe Sistemleri
Aluminium Window Doors and Facade Systems

COMP 50

AKSESUARLAR

ACCESSORIES

14

15

16

17

18

19

20

21



22

23

24

25

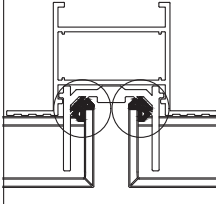
26

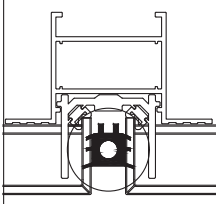
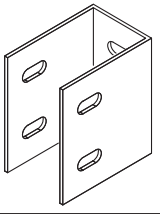
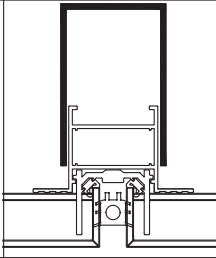
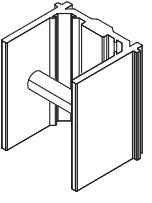
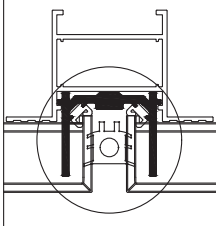
14					
15		01.07.10 FİTİL GASKET Malzeme / Material : EPDM Ağırlık / Weight : 72 gr/m Paket / Package: 208,3 m / 15 kg			
16					
17		01.07.14 DERZ FİTİLİ LINE GASKET Malzeme / Material : EPDM Ağırlık / Weight : 225 gr/m Paket / Package: 65 m / 15 kg			
18					
19		08.01.03 ALÜMİNYUM ANKRAJ ANCHORAGE (ALUMINIUM) Profil No: A010635 (1,895 kg/m) Profile No: A010635 (1,895 kg/m)			
20		08.01.04 ANAHTAR GEÇME BAĞLANTI CONNECTION PIECE Profil No: A010633 (1,056 kg/m) Profile No: A010633 (1,056 kg/m)			
21					
22					
23					
24					
25					
26					