

MOBİLYA PROFİLLERİ

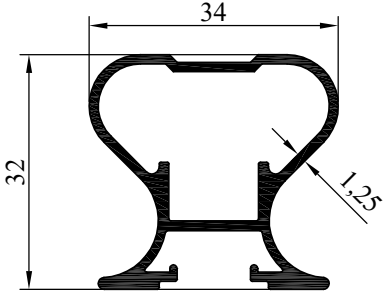

NO : 3478
AĞIRLIK : 0.527 kg/m

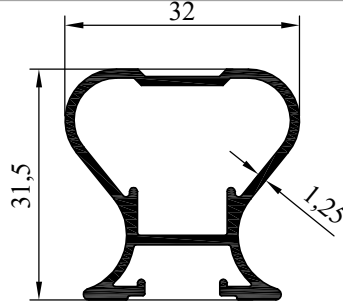

NO : 4452
AĞIRLIK : 0.460 kg/m

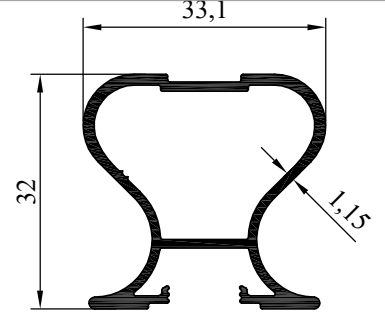

NO : 4411
AĞIRLIK : 0.474 kg/m

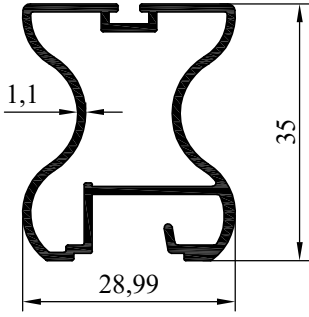

NO:6416
AĞIRLIK:485 gr/m

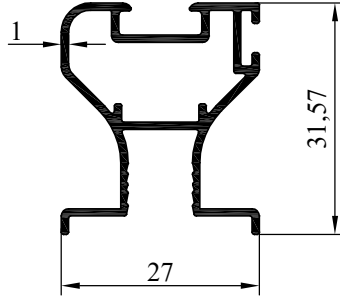

NO:6553
AĞIRLIK:381 gr/m

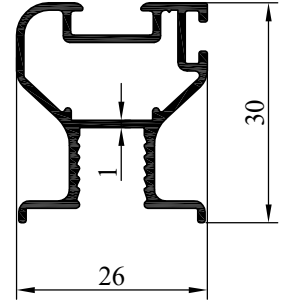

NO:6667
AĞIRLIK:379.7gr/m

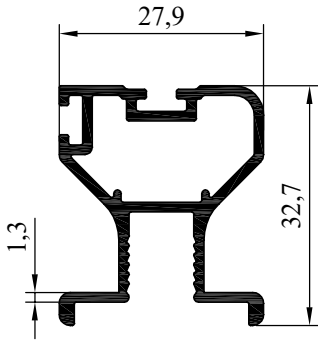

NO : 3523
AĞIRLIK : 0.507 kg/m

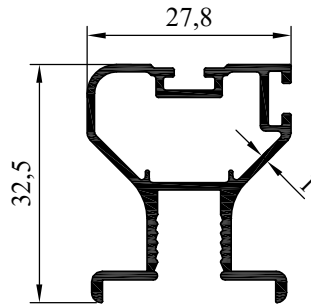

NO :3670
AĞIRLIK : 0.425 kg/m

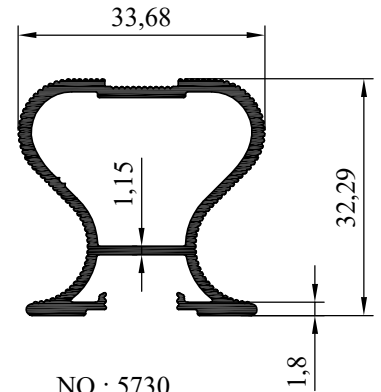

NO : 5730
AĞIRLIK : 527 gr/m

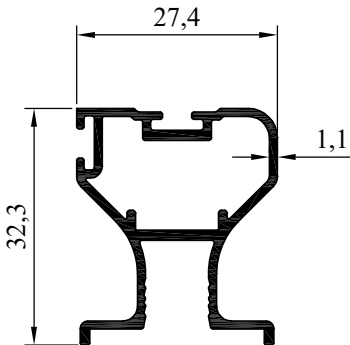

NO:7968 AĞIRLIK: 432 gr/m

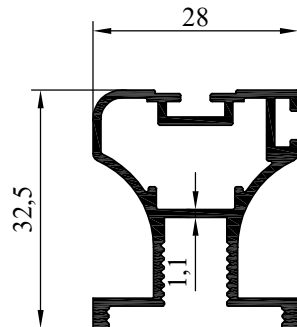

NO:7433 AĞIRLIK:474 gr/m

MOBİLYA PROFİLLERİ

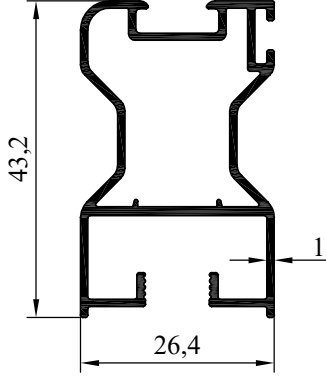

NO:6541 AĞIRLIK: 510 gr/m

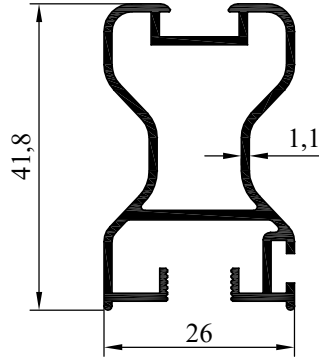

NO:6640 AĞIRLIK:518 gr/m

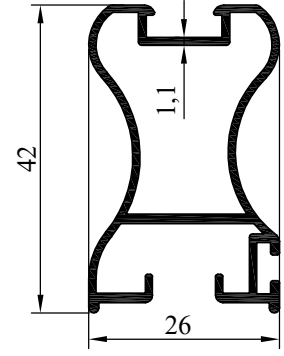

NO:6668 AĞIRLIK: 483 gr/m

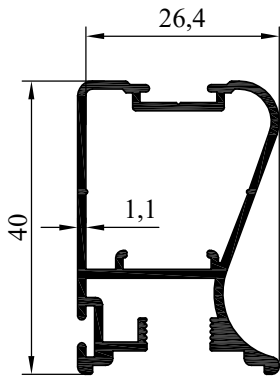

NO:6831 AĞIRLIK:516 gr/m

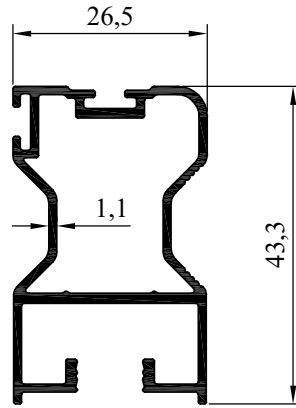

NO:7967 AĞIRLIK:556 gr/m

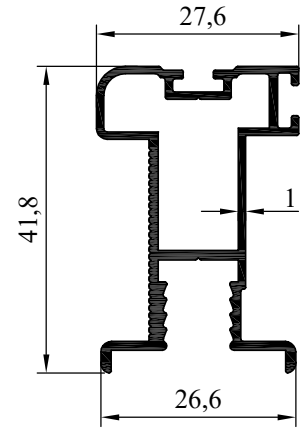

NO:5058 AĞIRLIK : 0.500 kg/m

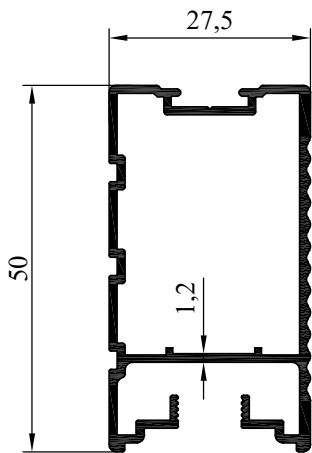

NO:6829 AĞIRLIK: 594 gr/m

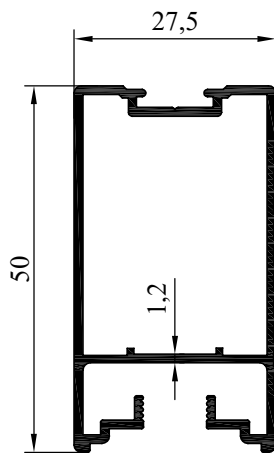

NO:6835 AĞIRLIK: 575 gr/m

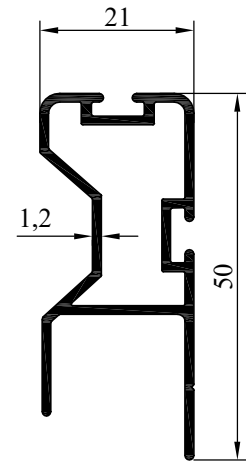

NO:5199 AĞIRLIK : 0.497 kg/m

MOBİLYA PROFİLLERİ

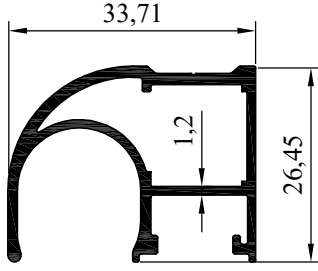

NO : 3477
AGIRLIK : 0.468 kg/m

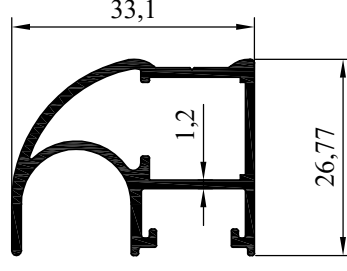

NO : 4451
AGIRLIK : 0.447 kg/m

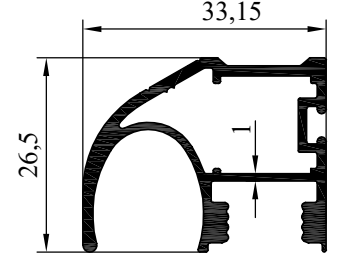

NO : 4412
AGIRLIK : 0.507 kg/m

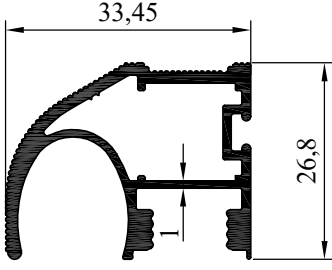

NO : 5731
AĞIRLIK : 535 gr/m

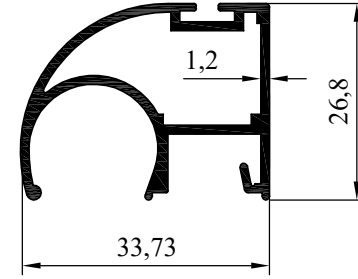

NO:6755 AĞIRLIK:463 gr/m

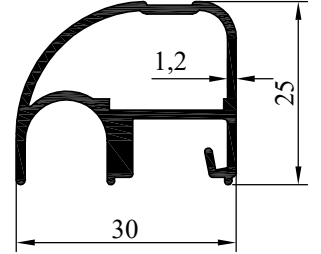

NO.6749 AĞIRLIK: 421 gr/m

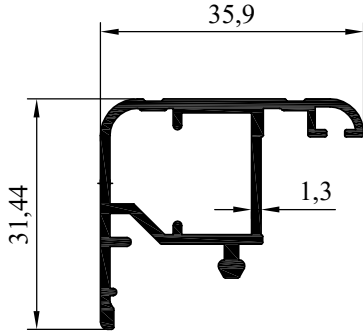

NO : 5027
AGIRLIK : 0.470 kg/m

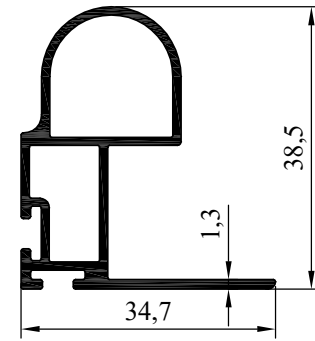

NO : 3406
AGIRLIK : 0.477 kg/m

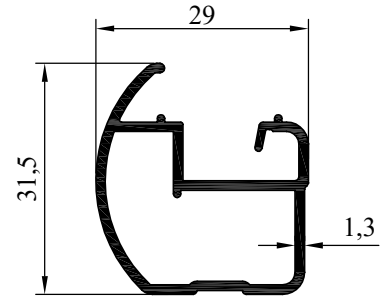

NO : 3542
AGIRLIK : 0.420 kg/m

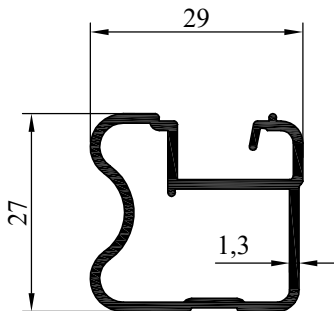

NO:6748 AĞIRLIK:424 gr/m

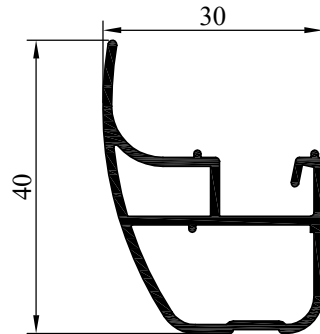

NO:6750 AĞIRLIK:448 gr/m

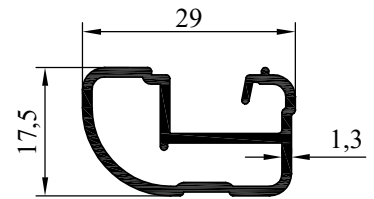

NO:6747 AĞIRLIK: 336 gr/m

MOBİLYA PROFİLLERİ

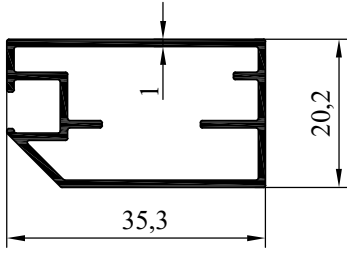

NO : 3774
AGIRLIK : 0.364 kg/m

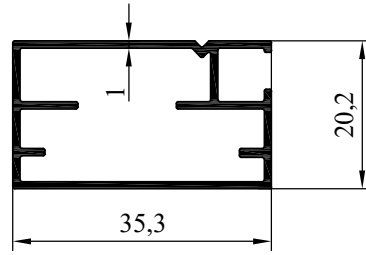

NO : 3775
AGIRLIK : 0.372 kg/m

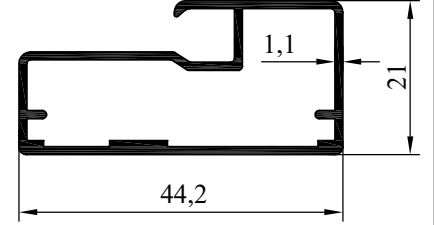

NO : 3808
AGIRLIK : 0.444 kg/m

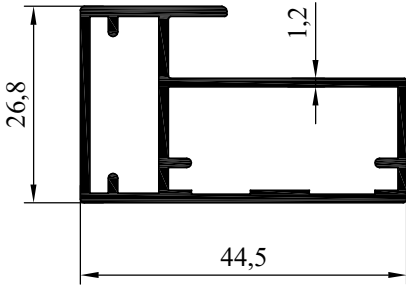

NO : 4274
AGIRLIK : 0.603 kg/m

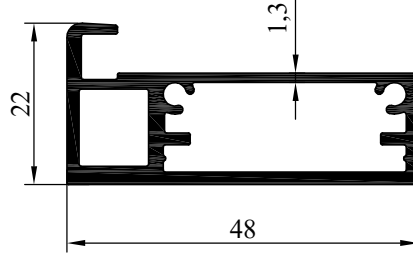

NO : 3572
AGIRLIK : 0.715 kg/m

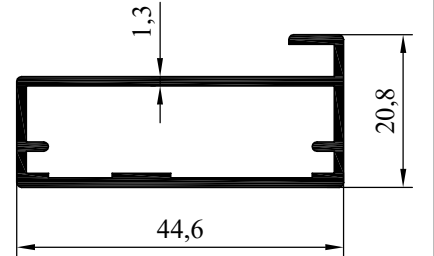

NO : 3806
AGIRLIK : 0.483 kg/m

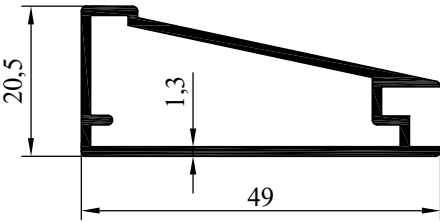

NO : 3632
AGIRLIK : 0.472 kg/m

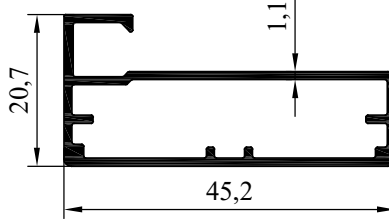

NO : 3558
AGIRLIK : 0.427 kg/m

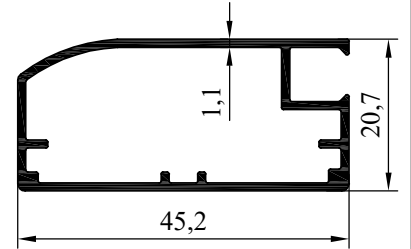

NO : 3559
AGIRLIK : 0.437 kg/m

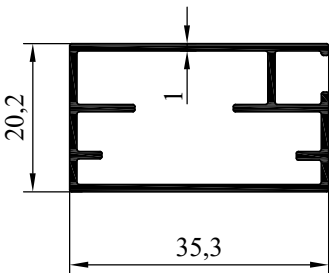

NO : 3771
AGIRLIK : 0.369 kg/m

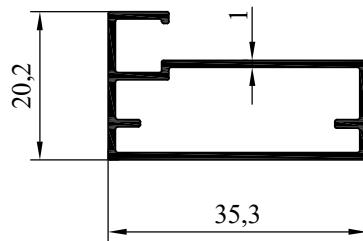

NO : 3772
AGIRLIK : 0.317 kg/m

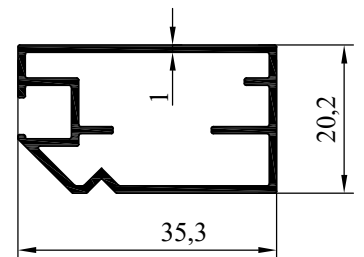

NO : 3773
AGIRLIK : 0.369 kg/m

MOBİLYA PROFİLLERİ

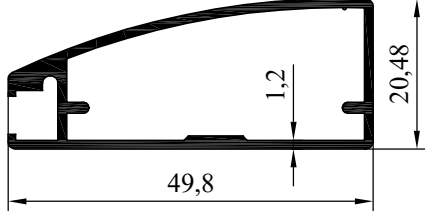

NO : 2021 AGIRLIK : 0.494 kg/m

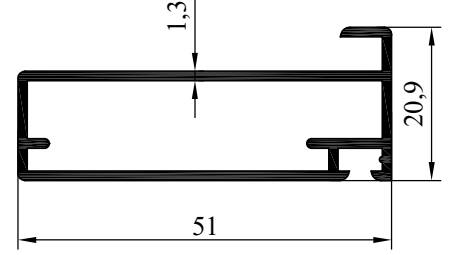

NO : 2022 AGIRLIK : 0.527 kg/m

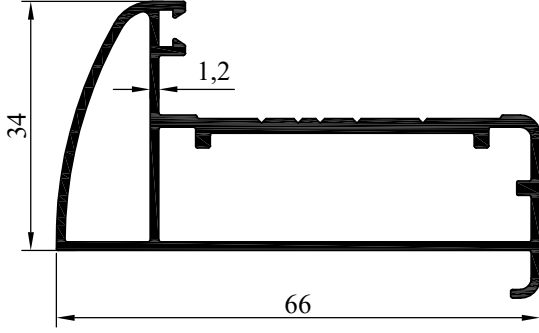

NO : 4420
AGIRLIK : 0.840 kg/m

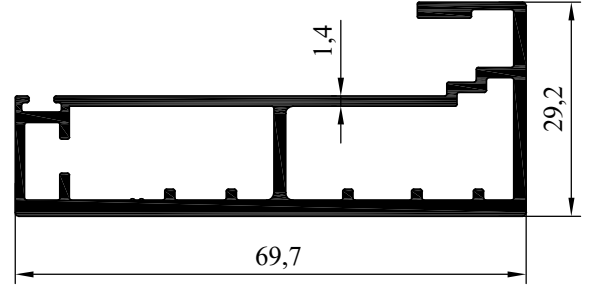

NO : 4987
AGIRLIK : 1.030 kg/m

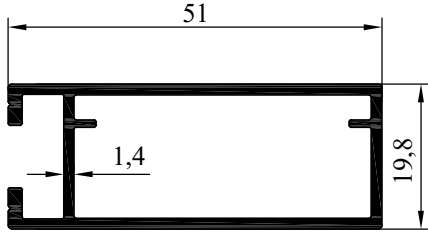

NO : 4807 AGIRLIK : 0.599 kg/m

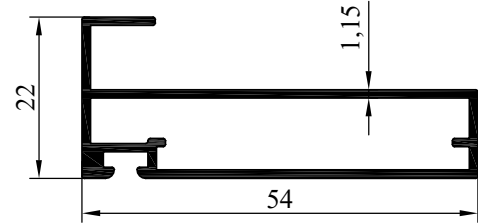

NO:6534 AĞIRLIK: 507 gr/m

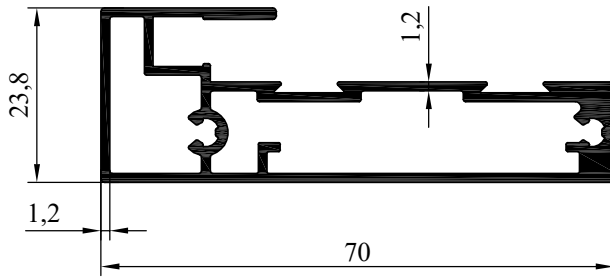

NO : 5822 AĞIRLIK : 882 gr/m

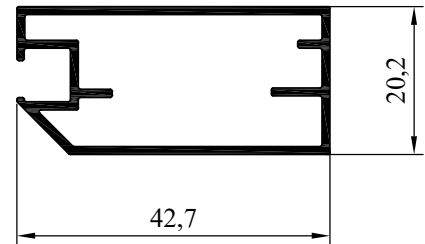

NO:7662 AĞIRLIK: 440 gr/m

MOBİLYA PROFİLLERİ

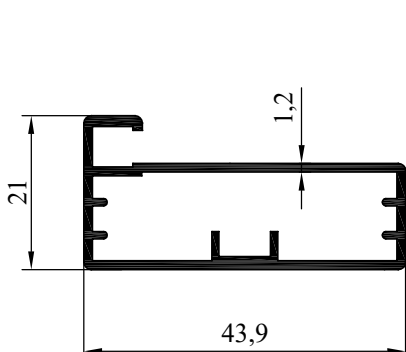

NO:6669 AĞIRLIK:467 gr/m

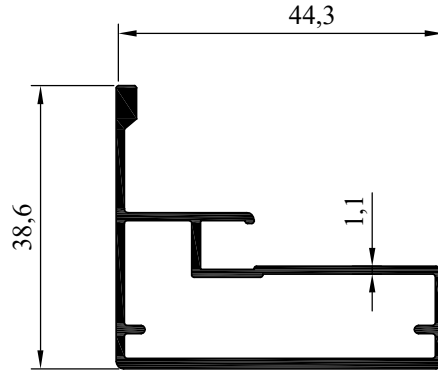

NO:7969 AĞIRLIK: 531 gr/m

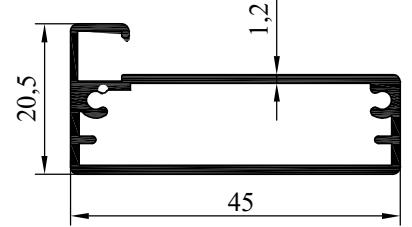

NO : 5712 AĞIRLIK : 456 gr/m

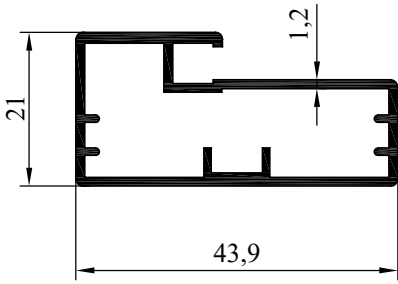

NO:6670 AĞIRLIK: 498 gr/m

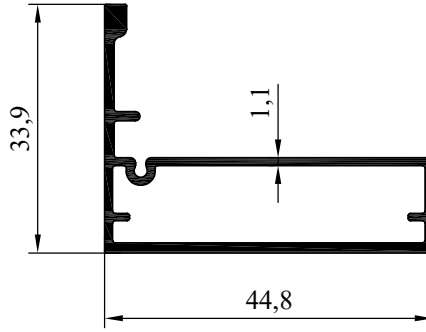

NO:7946 AĞIRLIK: 497 gr/m

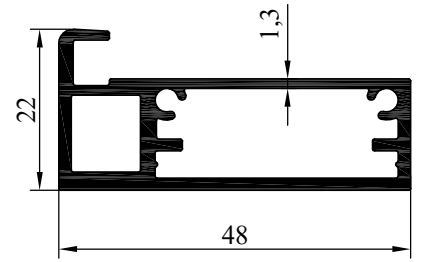

NO : 3572 AĞIRLIK : 0.715 kg/m

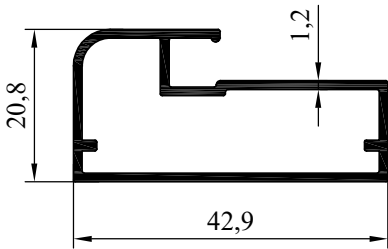

NO:7490 AĞIRLIK: 438 gr/m

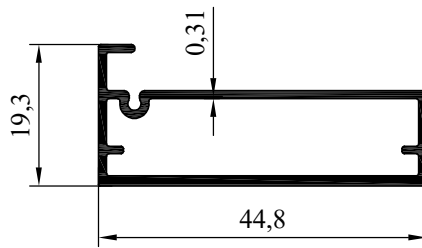

NO:7945 AĞIRLIK: 421 gr/m

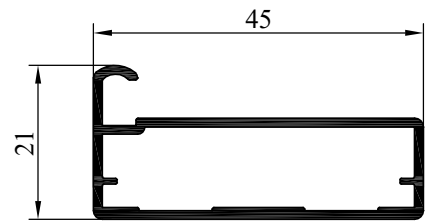

NO : 6205
AĞIRLIK : 436 gr/m

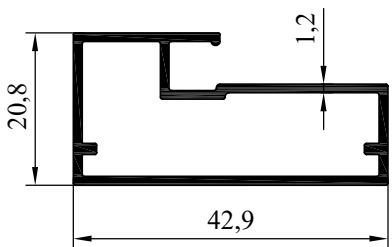

NO:7498 AĞIRLIK: 443 gr/m

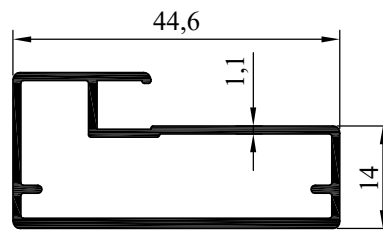

NO:7980 AĞIRLIK: 454 gr/m

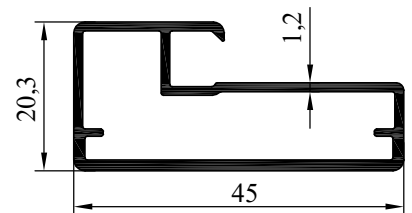

NO : 3840 AĞIRLIK : 0.487 kg/m

MOBİLYA PROFİLLERİ

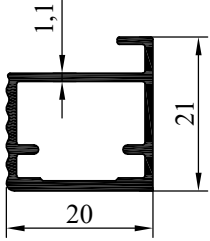

NO : 4519
AĞIRLIK : 0.270 kg/m

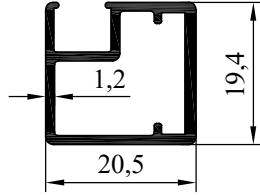

NO : 3620
AĞIRLIK : 0.290 kg/m

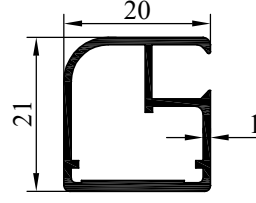

NO : 3631
AĞIRLIK : 0.257 kg/m

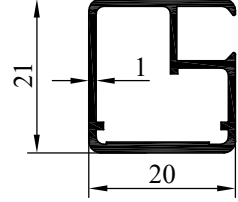

NO : 3807
AĞIRLIK : 0.261 kg/m

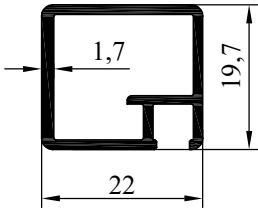

NO:6671
AĞIRLIK: 317 gr/m

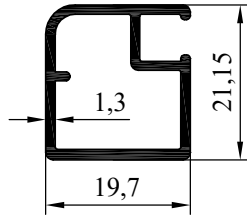

NO:6619
AĞIRLIK:301 gr/m

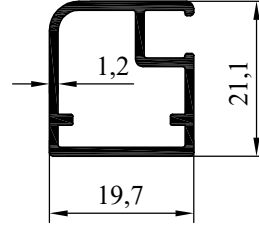

NO:7495
AĞIRLIK: 286 gr/m

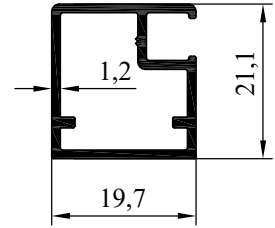

NO:7496
AĞIRLIK:289 gr/m

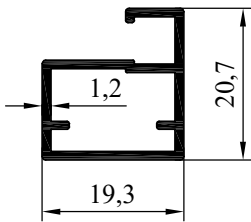

NO:7736
AĞIRLIK: 262 gr/m

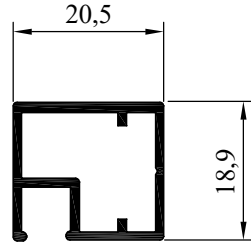

NO:7971
AĞIRLIK:276 gr/m

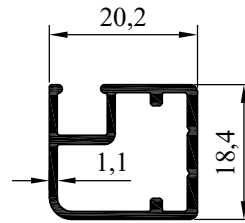

NO:7966
AĞIRLIK: 267 gr/m

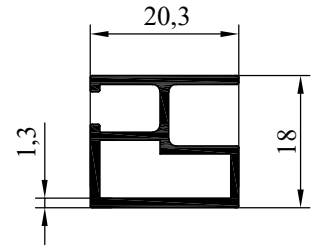

NO : 4852
AĞIRLIK : 0.279 kg/m

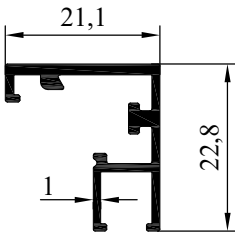

NO : 4957
AĞIRLIK : 0.259 kg/m

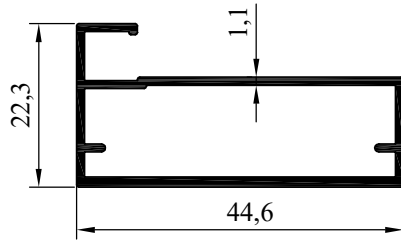

NO: 7961 AĞIRLIK: 438 gr/m

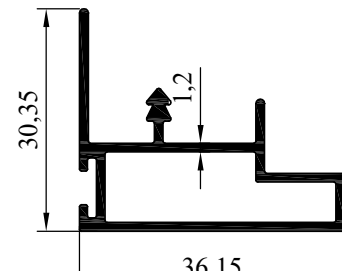

NO:8110 AĞIRLIK: 432 gr/m

MOBİLYA PROFİLLERİ

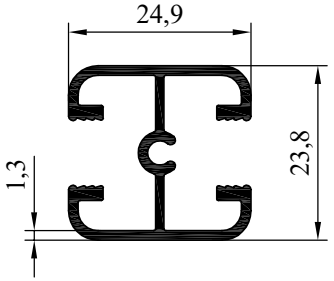

NO : 3522
AGIRLIK : 0.399 kg/m

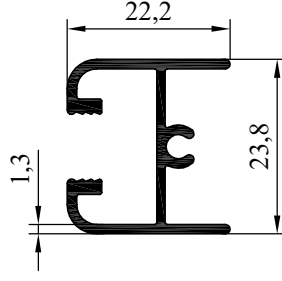

NO : 3521
AGIRLIK : 0.319 kg/m

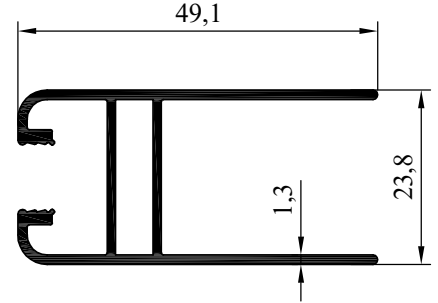

NO : 3520
AGIRLIK : 0.544 kg/m

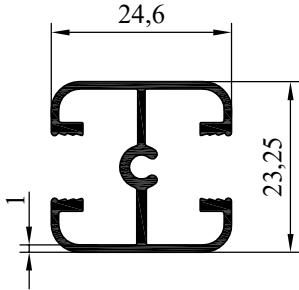

NO : 3671
AGIRLIK : 0.331 kg/m

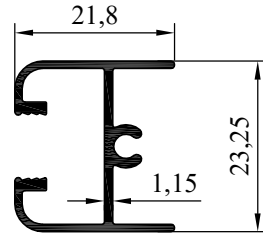

NO : 3672
AGIRLIK : 0.268 kg/m

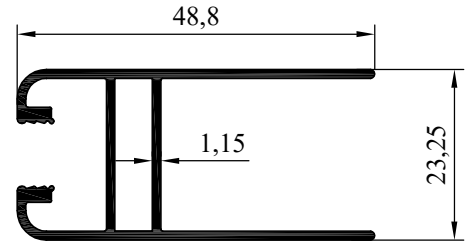

NO : 3673
AGIRLIK : 0.515 kg/m

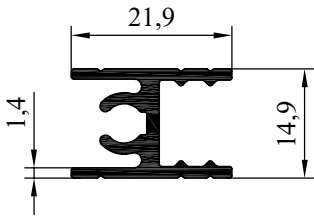

NO : 4425
AGIRLIK : 0.306 kg/m

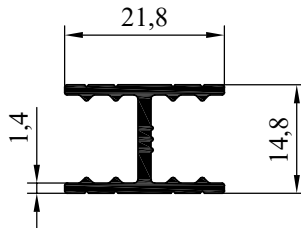

NO : 4427
AGIRLIK : 0.241 kg/m

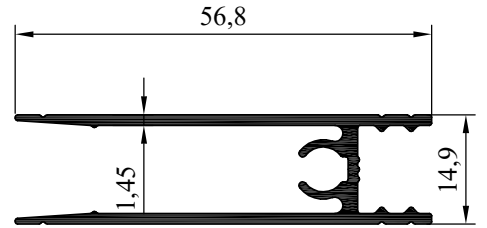

NO : 4426
AGIRLIK : 0.535 kg/m

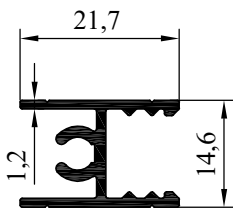

NO : 3472
AGIRLIK : 0.249 kg/m

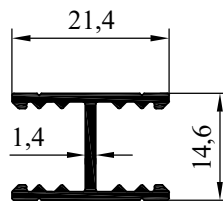

NO : 3473
AGIRLIK : 0.220 kg/m

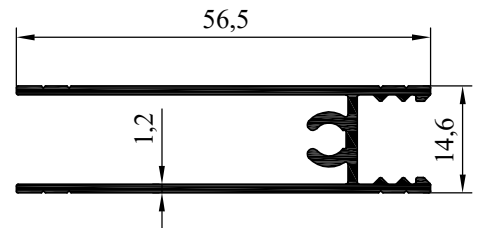

NO : 3475
AGIRLIK : 0.474 kg/m

MOBİLYA PROFİLLERİ

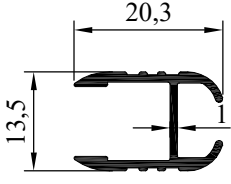

NO : 4834
AGIRLIK : 0.117 kg/m

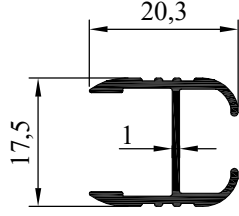

NO : 4835
AGIRLIK : 0.195 kg/m

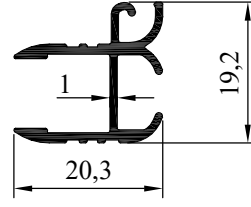

NO : 4836
AGIRLIK : 0.221 kg/m

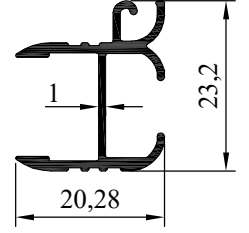

NO : 4837
AGIRLIK : 0.239 kg/m

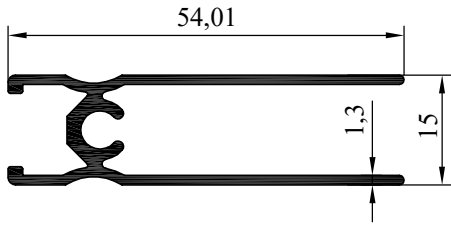

NO : 3541 AGIRLIK : 0.490 kg/m

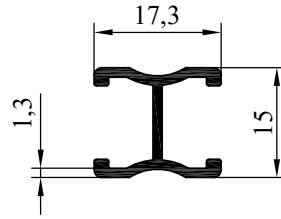

NO : 3540 AGIRLIK : 0.183 kg/m

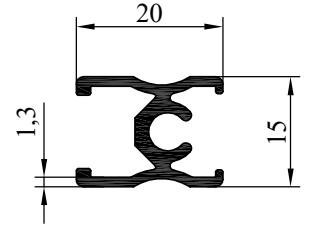

NO : 3543 AGIRLIK : 0.256 kg/m

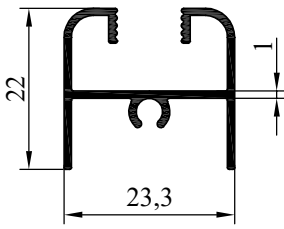

NO:6543 AĞIRLIK:247 gr/m

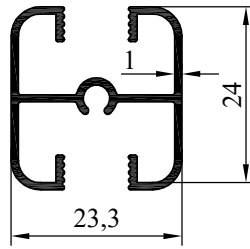

NO:6544 AĞIRLIK:304 gr/m

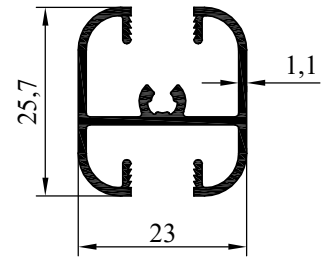

NO:6651 AĞIRLIK: 335 gr/m

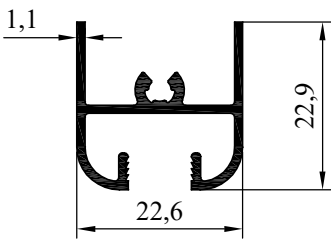

NO:6642 AĞIRLIK:285 gr/m

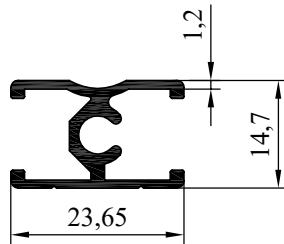

NO:6417 AĞIRLIK: 265 gr/m

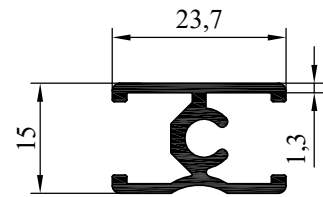

NO:6751 AĞIRLIK: 295 gr/m

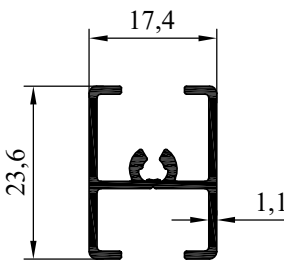

NO: 8062 AĞIRLIK: 257 gr/m

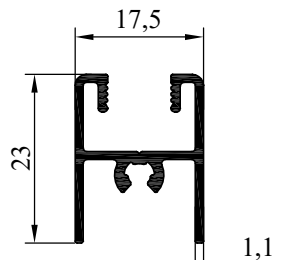

NO:6830 AĞIRLIK: 266 gr/m

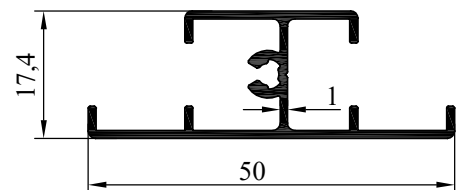

NO: 6832 AĞIRLIK: 355 gr/m

MOBİLYA PROFİLLERİ

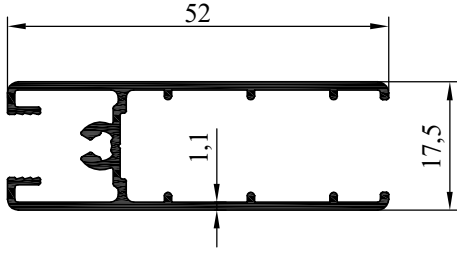

NO:6833 AĞIRLIK: 454 gr/m

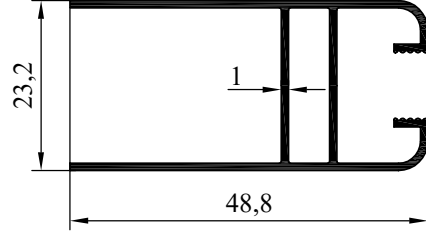

NO:6542 AĞIRLIK: 424 gr/m

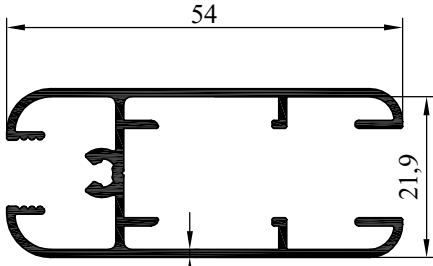

NO:6828 AĞIRLIK: 570 gr/m

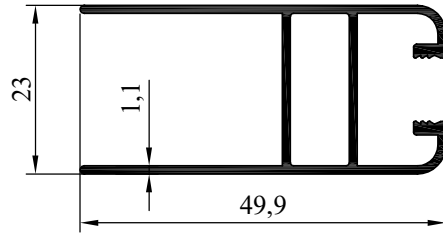

NO:6639 AĞIRLIK: 479 gr/m

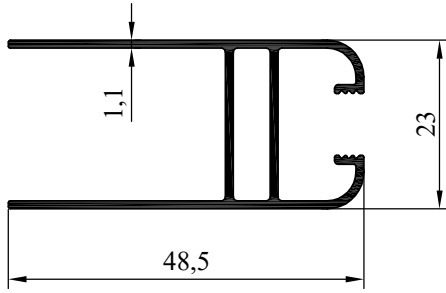

NO:7629 AĞIRLIK: 455 gr/m

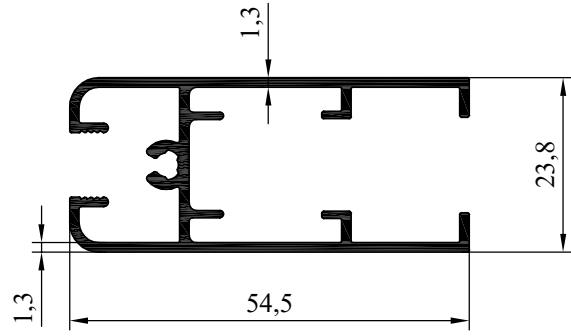

NO : 5955
AĞIRLIK : 656 gr/m

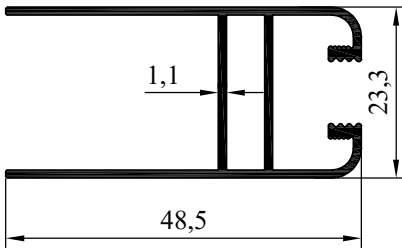

NO:7432 AĞIRLIK: 475 gr/m

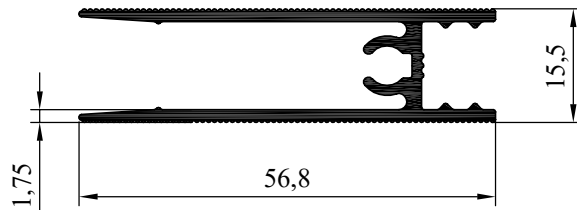

NO : 5728
AĞIRLIK : 605 gr/m

MOBİLYA PROFİLLERİ

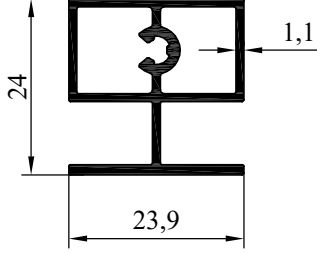

NO : 5821
AĞIRLIK : 394 gr/m

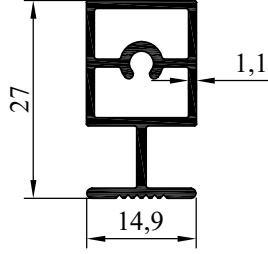

NO : 6094
AĞIRLIK : 320 gr/m

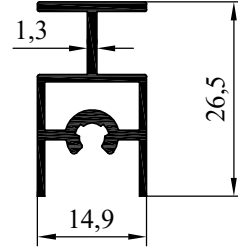

NO:7512
AĞIRLIK: 286 gr/m

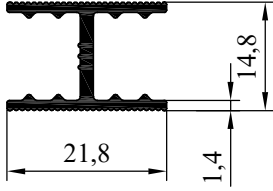

NO : 5729
AĞIRLIK : 230 gr/m

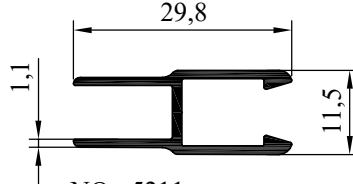

NO : 5211
AĞIRLIK : 0.234 kg/m

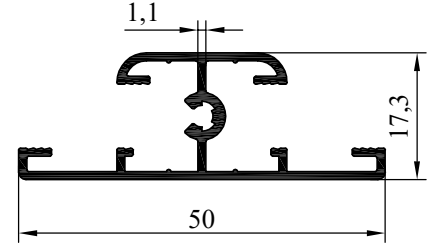

NO:6554
AĞIRLIK:385 gr/m

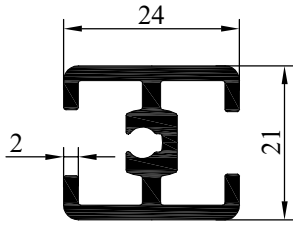

NO : 4249
AĞIRLIK : 0.513 kg/m

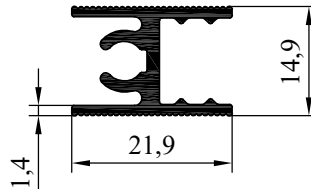

NO : 5727
AĞIRLIK : 296 gr/m

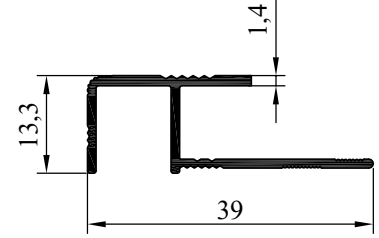

NO:6419
AĞIRLIK: 235 gr/m

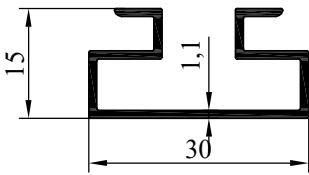

NO:7983
AĞIRLIK: 257 gr/m

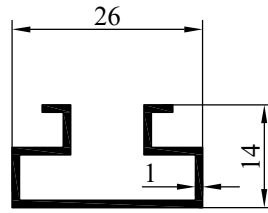

NO : 6320
AĞIRLIK : 195 gr/m

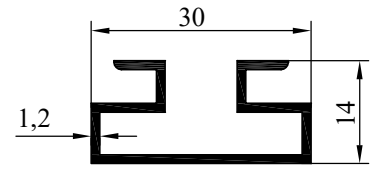

NO : 6321
AĞIRLIK : 275 gr/m

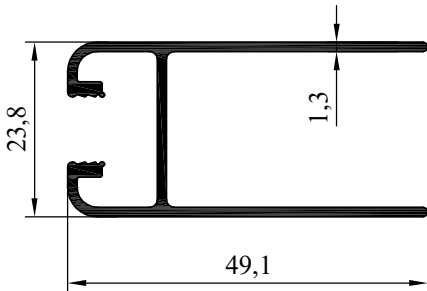

NO : 5694 AĞIRLIK : 489 gr/m

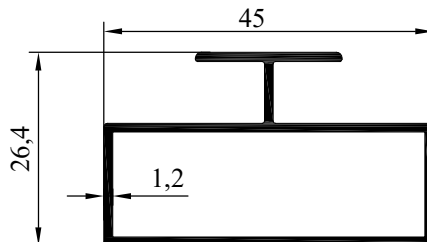

NO : 4275 AĞIRLIK : 0.480 kg/m

MOBİLYA PROFİLLERİ

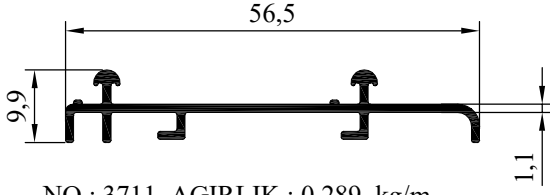

NO : 3711 AGIRLIK : 0.289 kg/m

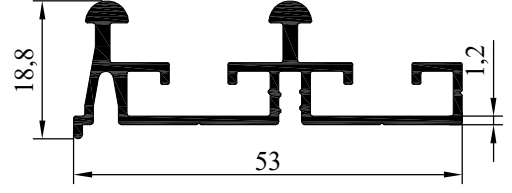

NO : 4819 AGIRLIK : 0.532 kg/m

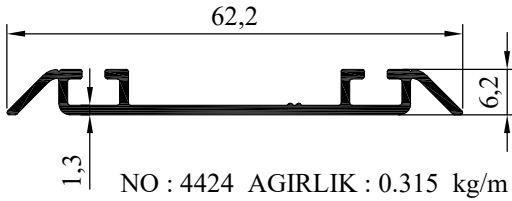

NO : 4424 AGIRLIK : 0.315 kg/m

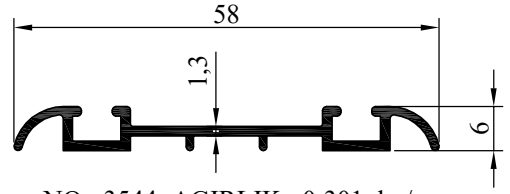

NO : 3544 AGIRLIK : 0.301 kg/m

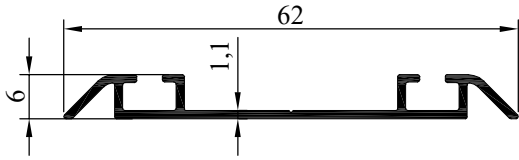

NO : 3474 AGIRLIK : 0.274 kg/m

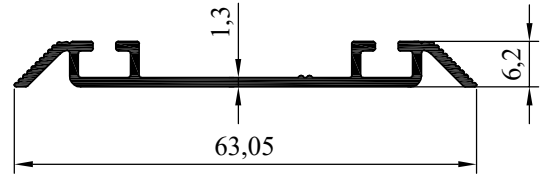

NO : 5726 AĞIRLIK : 325 gr/m

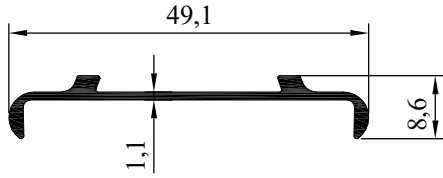

NO : 4756 AGIRLIK : 0.222 kg/m

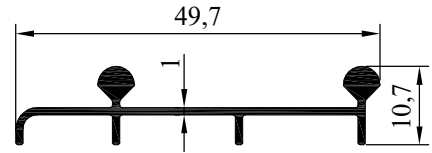

NO : 3668 AGIRLIK : 0.264 kg/m

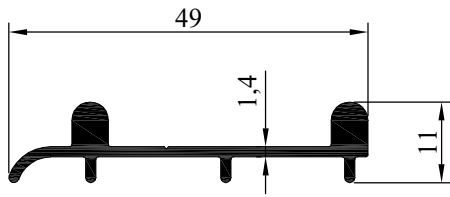

NO : 3392 AGIRLIK : 0.379 kg/m

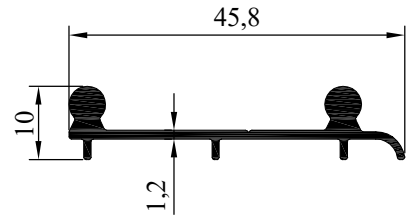

NO : 3403 AGIRLIK : 0.305 kg/m

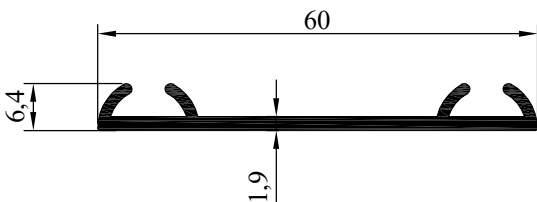

NO : 3398 AGIRLIK : 0.396 kg/m

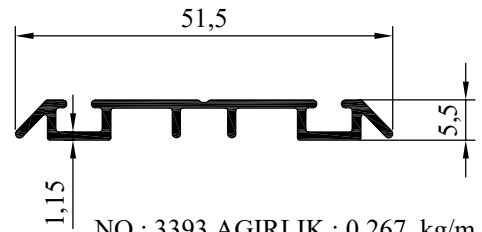

NO : 3393 AGIRLIK : 0.267 kg/m

MOBİLYA PROFİLLERİ

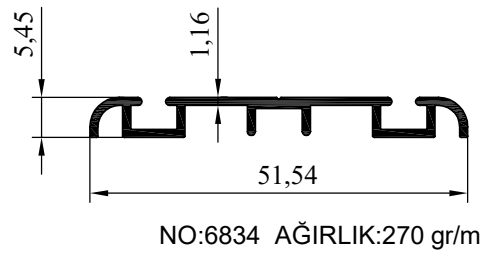
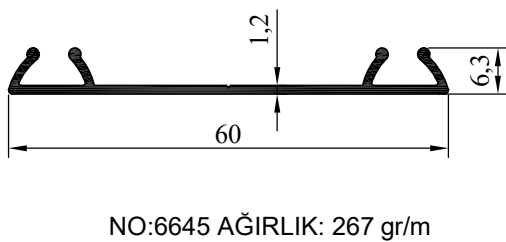
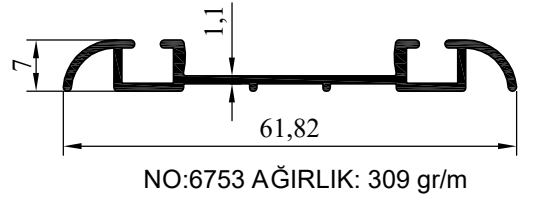
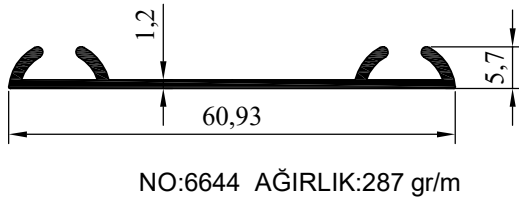
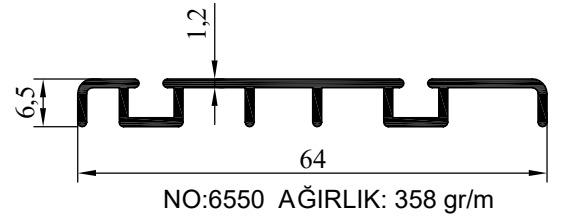
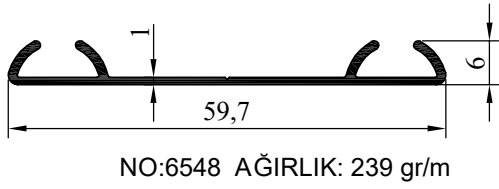
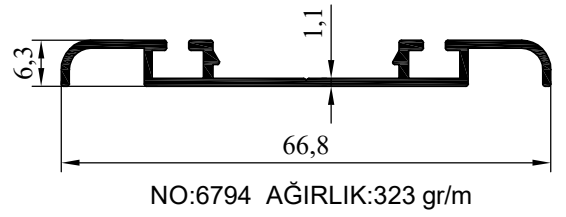
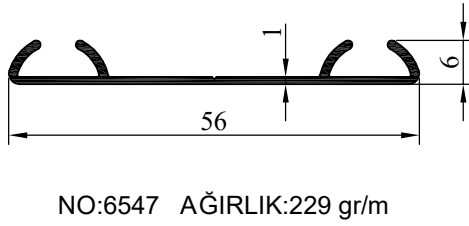
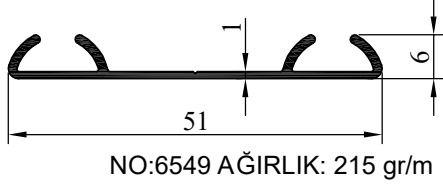

MOBİLYA PROFİLLERİ

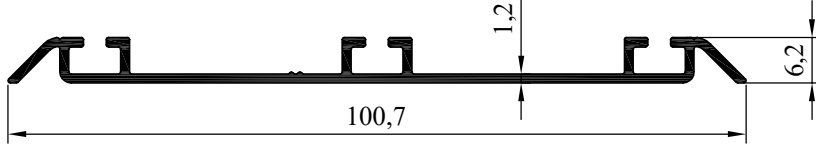

NO:6511 AĞIRLIK:476 gr/m

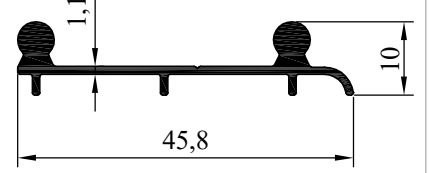

NO:6653 AĞIRLIK: 298 gr/m

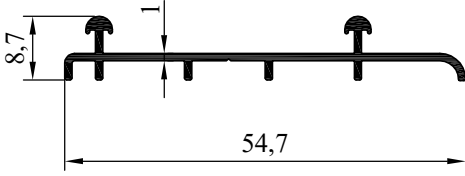

NO:6540 AĞIRLIK: 235 gr/m

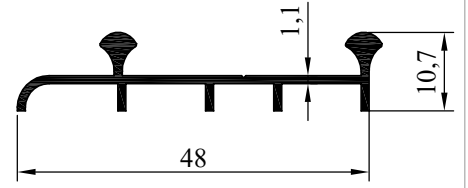

NO:6641 AĞIRLIK:276 gr/m

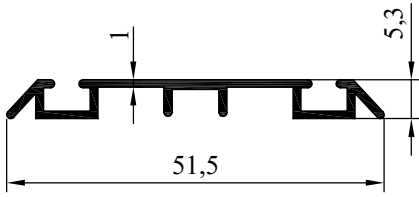

NO:7434 AĞIRLIK: 243 gr/m

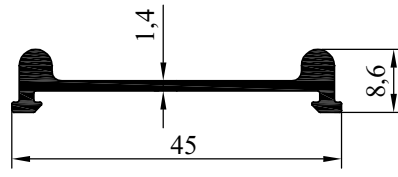

NO:8107 AĞIRLIK: 303 gr/m



NO:7407 AĞIRLIK: 247 gr/m

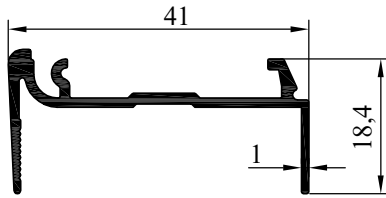

NO:6597 AĞIRLIK:304 gr/m

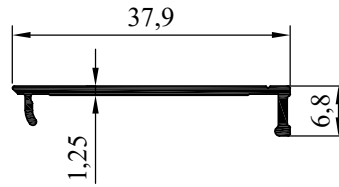

NO:6598 AĞIRLIK:155 gr/m

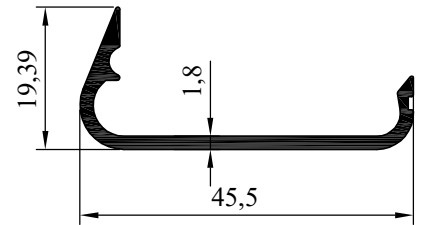

NO:6599 AĞIRLIK: 333 gr/m

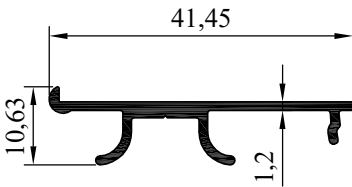

NO:6600 AĞIRLIK:242 gr/m

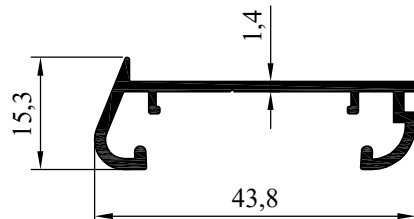

NO:6601 AĞIRLIK:320 gr/m

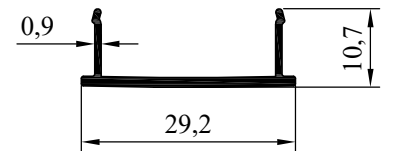

NO:6602 AĞIRLIK: 148 gr/m

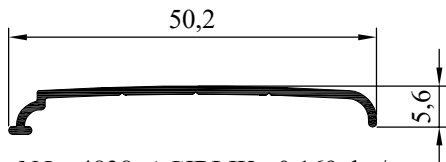

NO : 4838 AĞIRLIK : 0.169 kg/m

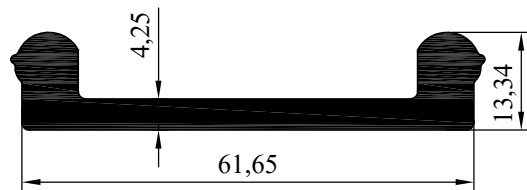

NO:7776 AĞIRLIK:1080 gr/m

MOBİLYA PROFİLLERİ

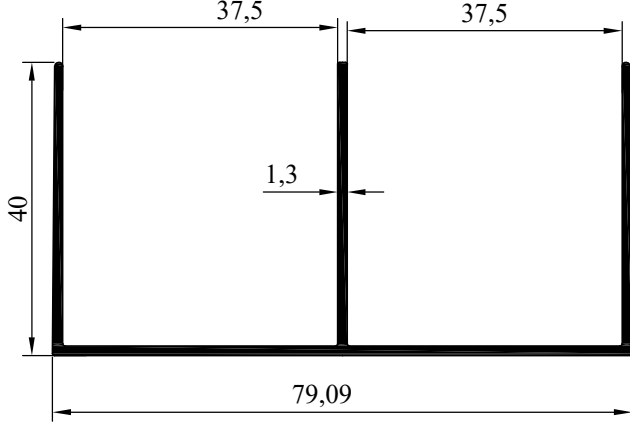

NO : 4450 AGIRLIK : 0.673 kg/m

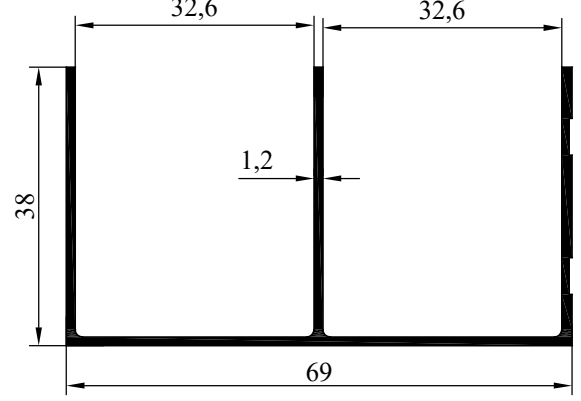

NO : 3669 AGIRLIK : 0.592 kg/m

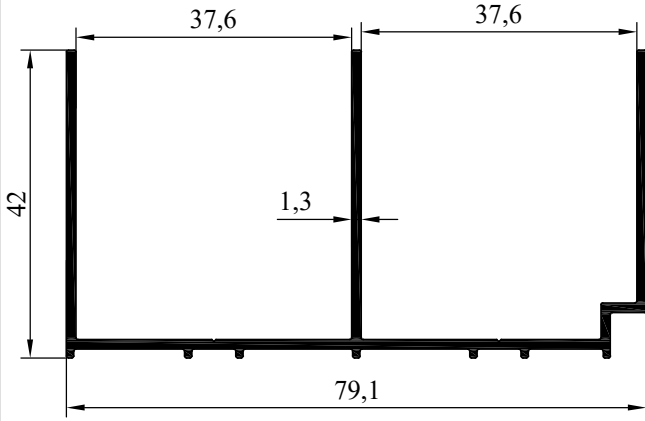

NO : 3476 AGIRLIK : 0.716 kg/m

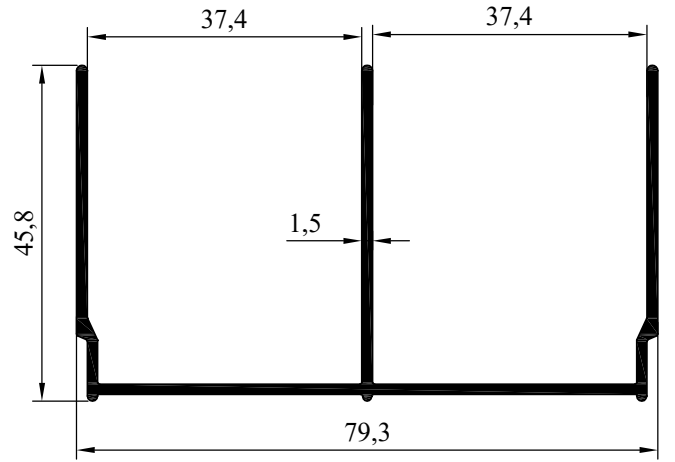

NO : 4423 AGIRLIK : 0.829 kg/m

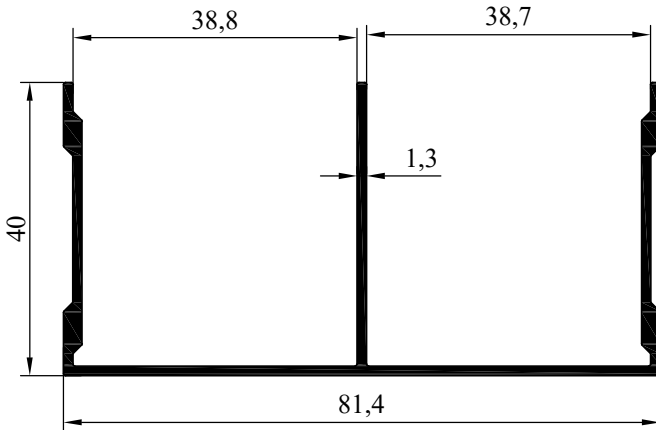

NO : 3640 AGIRLIK : 0.764 kg/m

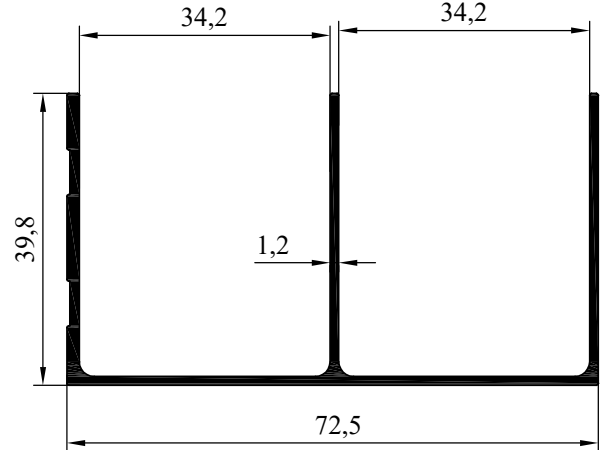

NO : 3524 AGIRLIK : 0.658 kg/m

MOBİLYA PROFİLLERİ

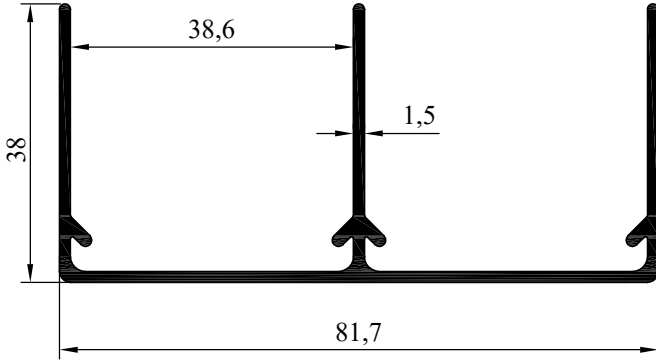

NO:8111 AĞIRLIK: 845 gr/m

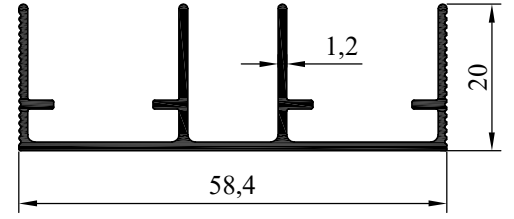

NO:7410 AĞIRLIK:467 gr/m

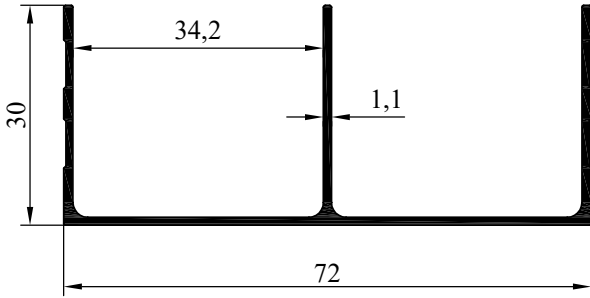

NO:7431 AĞIRLIK: 492 gr/m

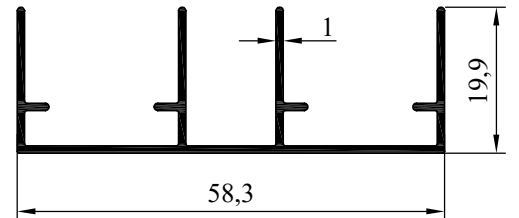

NO:6552 AĞIRLIK:397 gr/m

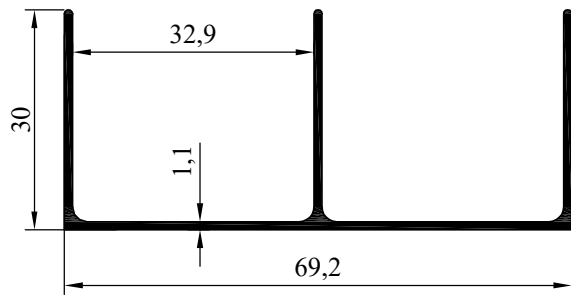

NO:7515 AĞIRLIK: 473 gr/m

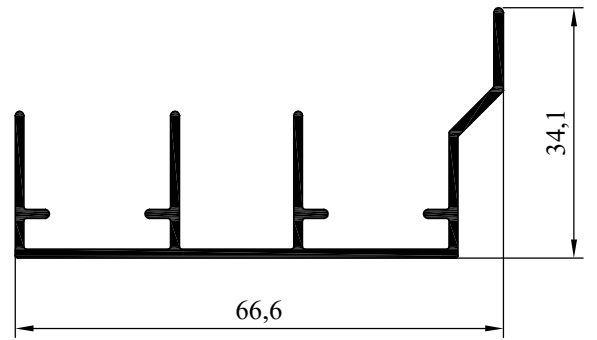

NO:7958 AĞIRLIK: 577 gr/m

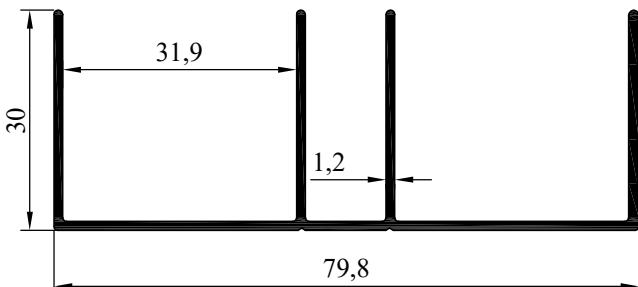

NO:7965 AĞIRLIK: 640 gr/m

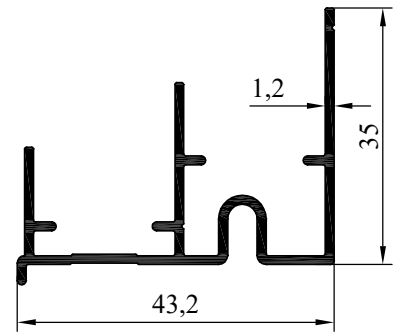

NO:8108 AĞIRLIK: 467 gr/m

MOBİLYA PROFİLLERİ

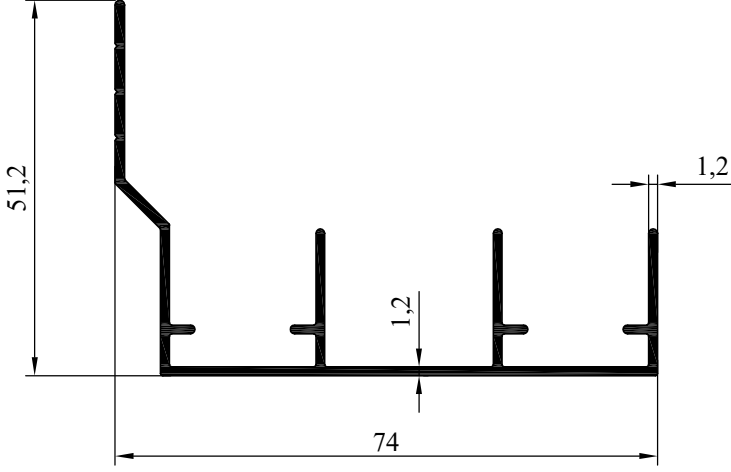

NO : 5770 AĞIRLIK : 624 gr/m

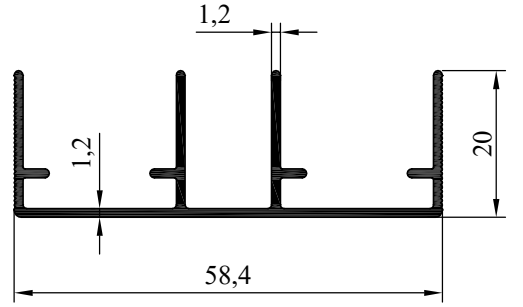

NO : 5642 AĞIRLIK: 470 gr/m

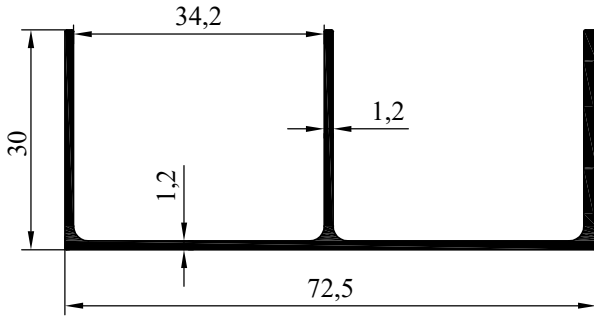

NO : 5541 AĞIRLIK : 550 gr/m

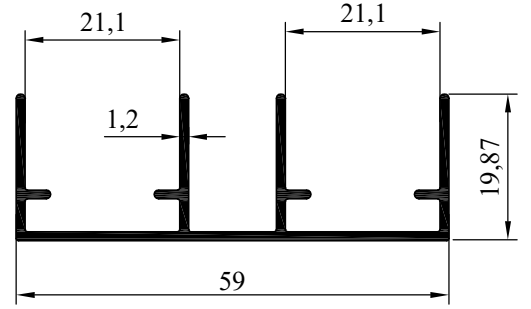

NO : 3399 AĞIRLIK : 0.477 kg/m

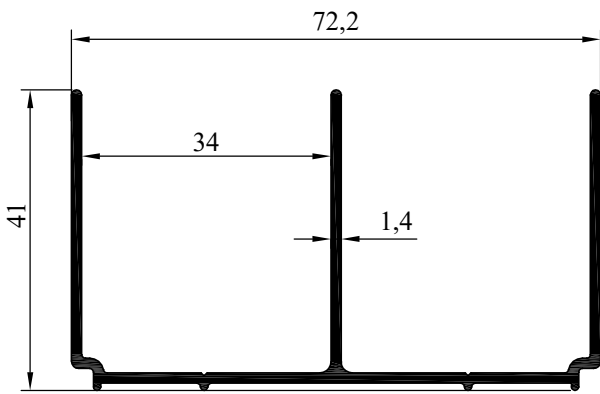

NO : 3545 AĞIRLIK : 0.716 kg/m

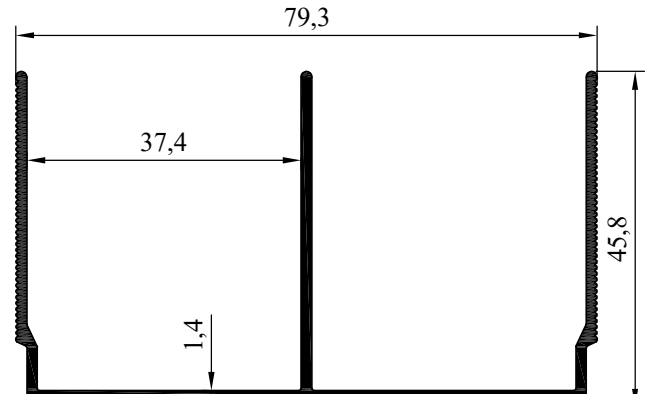

NO : 5725 AĞIRLIK : 807 gr/m

MOBİLYA PROFİLLERİ

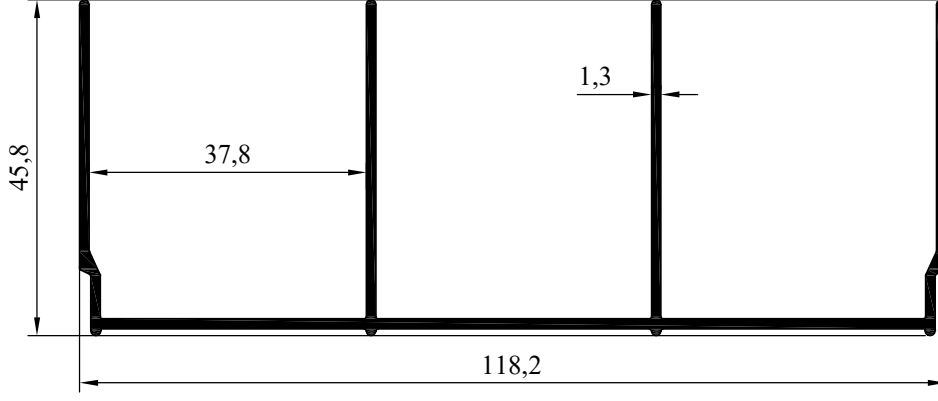

NO:6512 AĞIRLIK:1070 gr/m

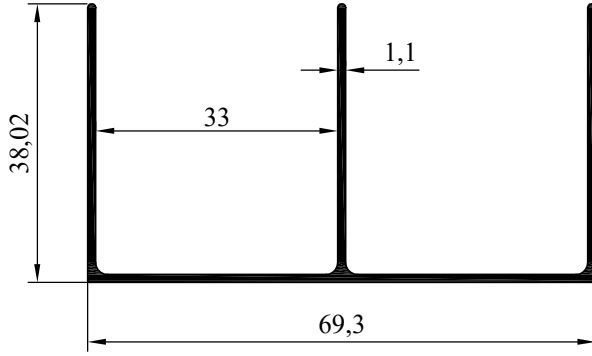

NO:6643 AĞIRLIK: 541 gr/m

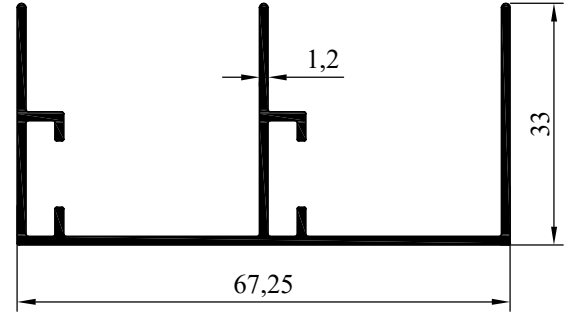

NO:7687 AĞIRLIK: 604 gr/m

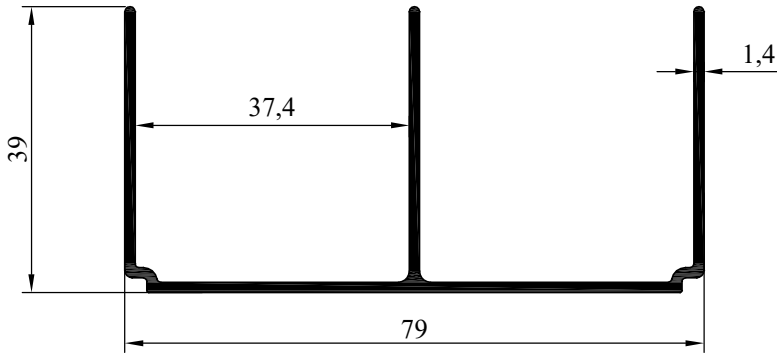

NO:6752 AĞIRLIK: 722 gr/m

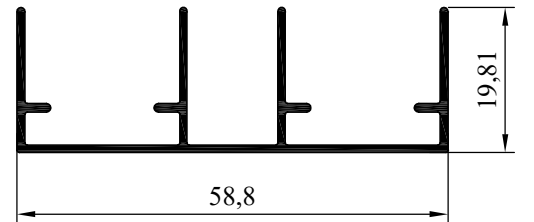

NO:6652 AĞIRLIK: 416 gr/m

MOBİLYA PROFİLLERİ

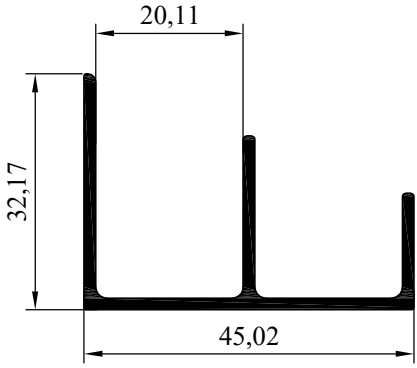

NO : 4854 AGIRLIK : 0.488 kg/m

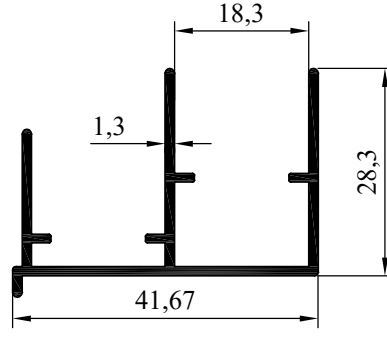

NO : 4817 AGIRLIK : 0.444 kg/m

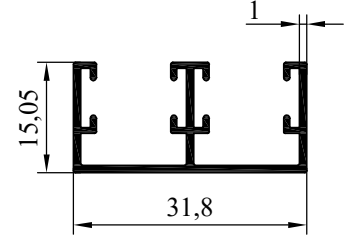

NO : 5213 AGIRLIK : 0.266 kg/m

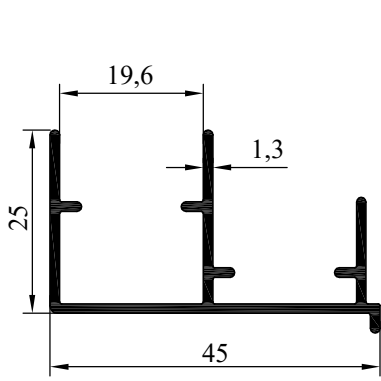

NO : 3953 AGIRLIK : 0.423 kg/m

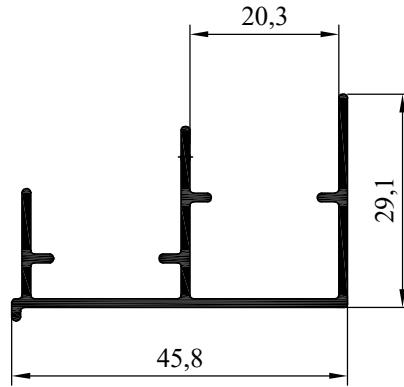

NO : 3405 AGIRLIK : 0.407 kg/m

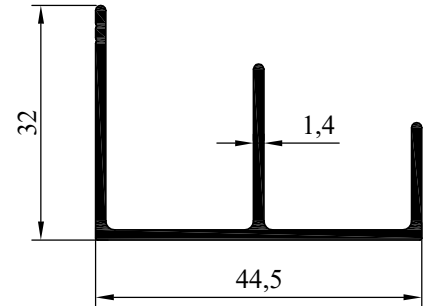

NO:7767 AĞIRLIK: 427 gr/m

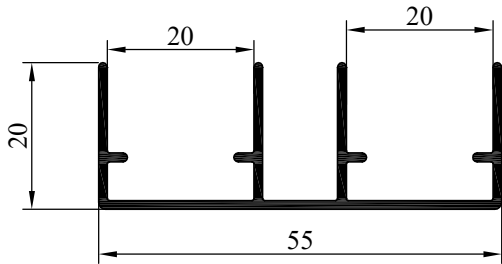

NO : 3952 AGIRLIK : 0.453 kg/m

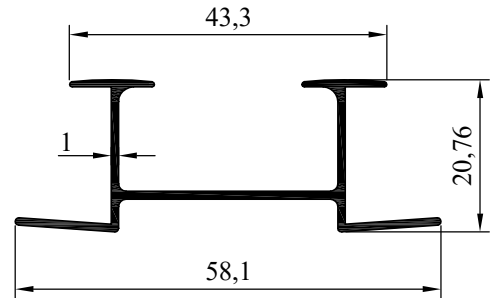

NO : 4717 AGIRLIK : 0.328 kg/m

MOBİLYA PROFİLLERİ

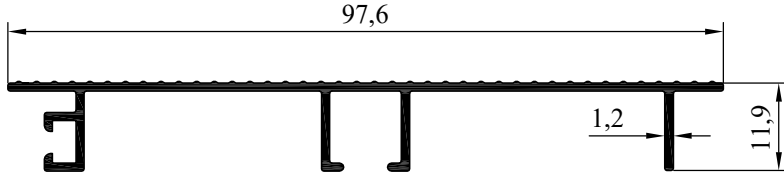

NO : 4421 AGIRLIK : 0.481 kg/m

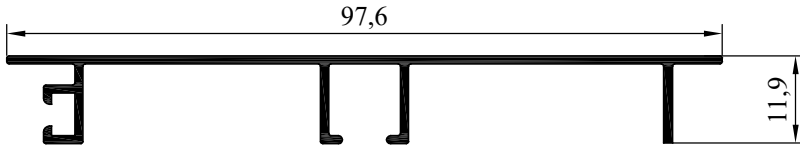

NO : 3527 AGIRLIK : 0.466 kg/m

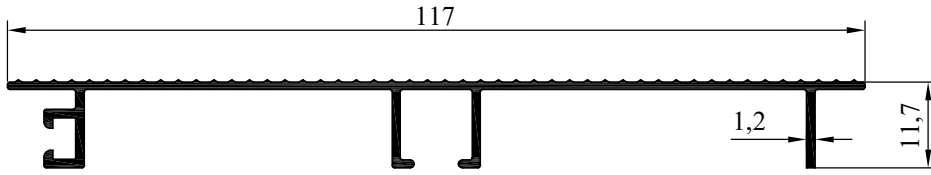

NO : 3525 AGIRLIK : 0.514 kg/m

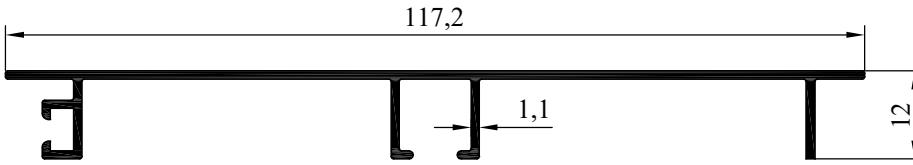

NO : 3526 AGIRLIK : 0.524 kg/m

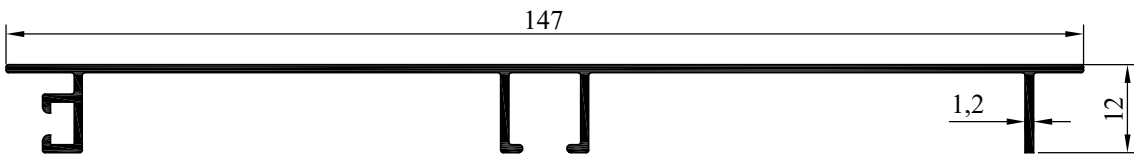

NO : 3528 AGIRLIK : 0.613 kg/m

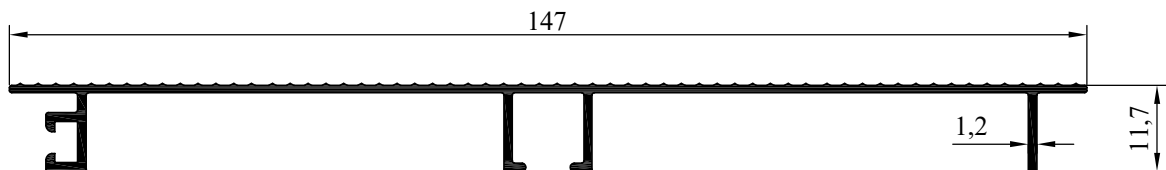

NO : 3530 AGIRLIK : 0.600 kg/m

MOBİLYA PROFİLLERİ

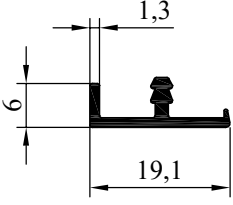

NO : 5096
AGIRLIK : 0.119 kg/m

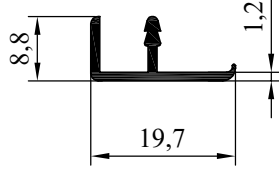

NO : 3805
AGIRLIK : 0.117 kg/m

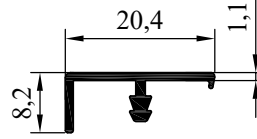

NO:6666
AĞIRLIK:113.4 gr/m

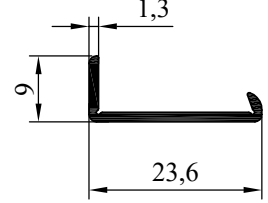

NO:7174
ĞIRLIK:116 gr/m

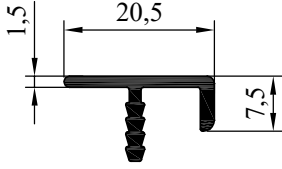

NO : 4518
AGIRLIK : 0.167 kg/m

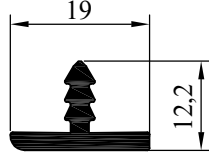

NO : 3689
AGIRLIK : 0.201 kg/m

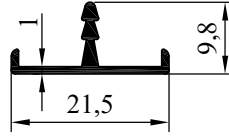

NO : 4956
AGIRLIK : 0.109 kg/m

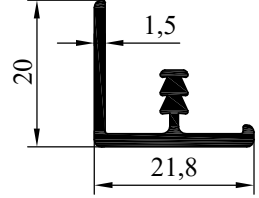

NO : 3838
AGIRLIK : 0.241 kg/m

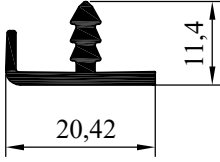

NO : 3685
AGIRLIK : 0.191 kg/m

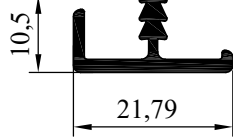

NO : 3837
AGIRLIK : 0.195 kg/m

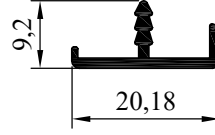

NO : 4258
AGIRLIK : 0.132 kg/m

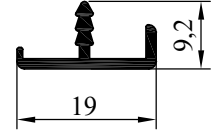

NO : 4259
AGIRLIK : 0.127 kg/m

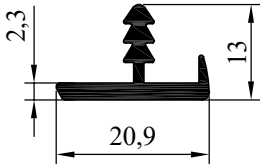

NO : 4955
AGIRLIK : 0.210 kg/m

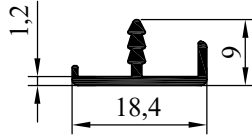

NO : 3579
AGIRLIK : 0.114 kg/m

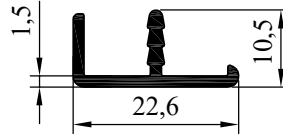

NO : 4003
AGIRLIK : 0.172 kg/m

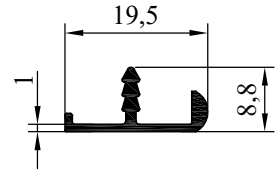

NO : 3471
AGIRLIK : 0.113 kg/m

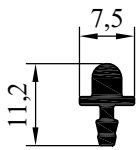

NO : 3950
AGIRLIK : 0.101 kg/m

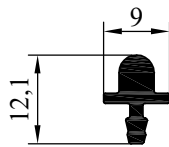

NO : 3951
AGIRLIK : 0.128 kg/m

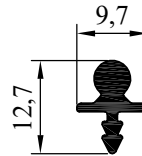

NO : 3394
AGIRLIK : 0.124 kg/m

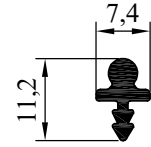

NO : 3395
AGIRLIK : 0.098 kg/m

MOBİLYA PROFİLLERİ

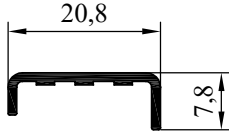

NO:7497
AĞIRLIK:111 gr/m

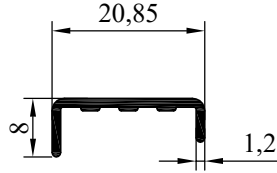

NO:6663
AĞIRLIK:111.6 gr/m

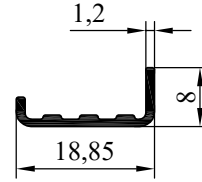

NO : 5711
AĞIRLIK : 92 gr/m

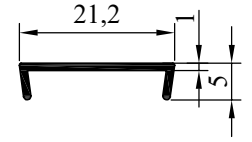

NO : 5845
AĞIRLIK : 78 gr/m

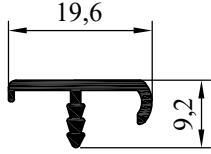

NO : 6203
AĞIRLIK : 128 gr/m

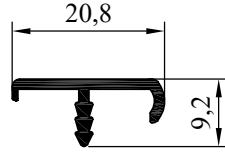

NO : 6204
AĞIRLIK : 134 gr/m

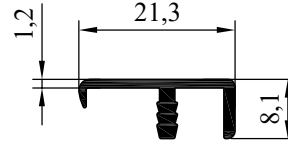

NO:6665
AĞIRLIK:144.7 gr/m

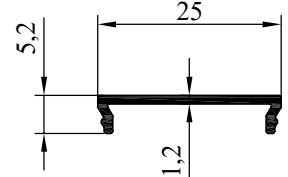

NO:6795
AĞIRLIK: 111 gr/m

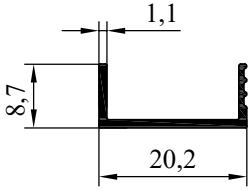

NO:7627
AĞIRLIK: 101 gr/m

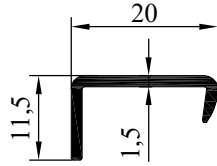

NO : 3404
AGIRLIK : 0.135 kg/m

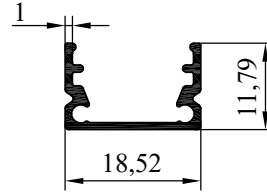

NO : 4950
AGIRLIK : 0.139 kg/m

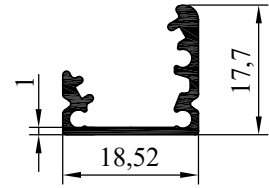

NO : 4951
AGIRLIK : 0.181 kg/m

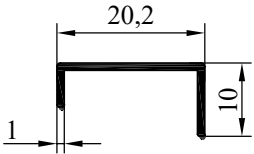

NO : 5844
AĞIRLIK : 92 gr/m

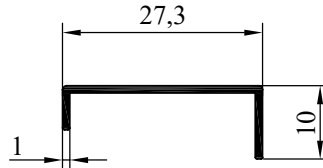

NO : 5842
AĞIRLIK : 112 gr/m

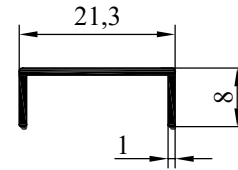

NO : 5843
AĞIRLIK : 96 gr/m

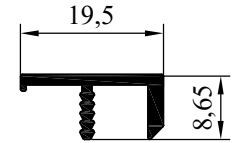

NO : 5236
AGIRLIK : 0.150 kg/m

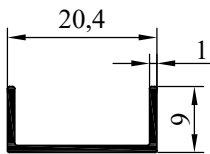

NO : 4428
AGIRLIK : 0.098 kg/m

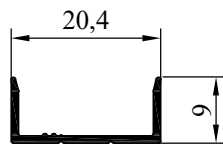

NO : 4808
AGIRLIK : 0.096 kg/m

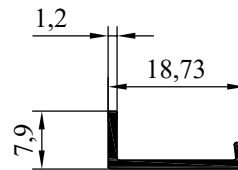

NO : 3776
AGIRLIK : 0.090 kg/m

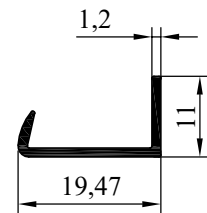

NO : 4041
AGIRLIK : 0.110 kg/m

MOBİLYA PROFİLLERİ

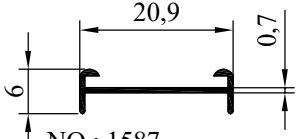

NO : 1587
AGIRLIK : 0.066 kg/m

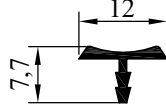

NO : 1093
AGIRLIK : 0.059 kg/m

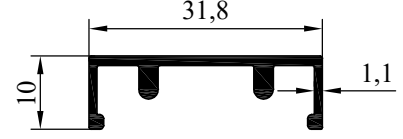

NO : 5212
AGIRLIK : 0.235 kg/m

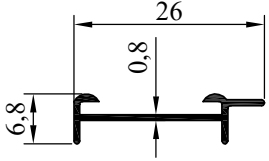

NO : 2056
AGIRLIK : 0.090 kg/m

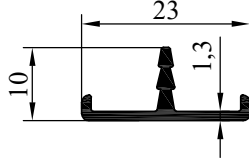

NO : 763
AGIRLIK : 0.136 kg/m

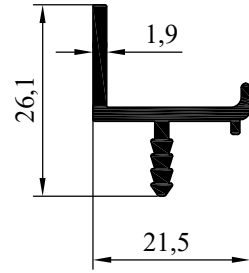

NO:7479
AĞIRLIK: 262 gr/m

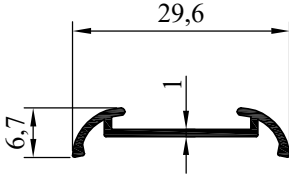

NO : 1011
AGIRLIK : 0.122 kg/m

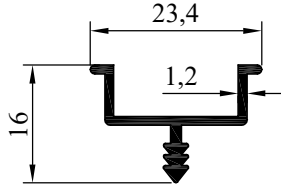

NO : 1087
AGIRLIK : 0.164 kg/m

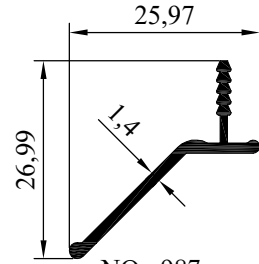

NO : 987
AGIRLIK : 0.167 kg/m

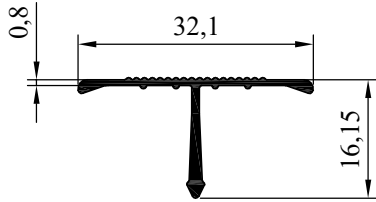

NO : 3778 AGIRLIK : 0.148 kg/m

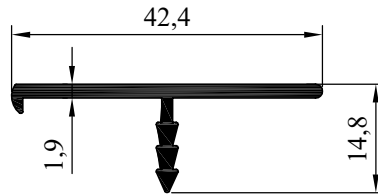

NO : 5823 AĞIRLIK : 292 gr/m

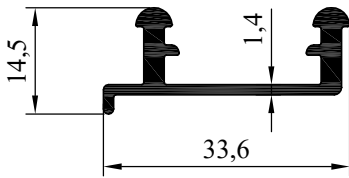

NO : 3954
AGIRLIK : 0.320 kg/m

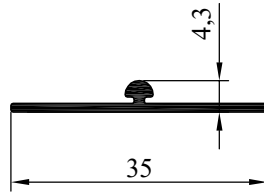

NO : 5026
AGIRLIK : 0.136 kg/m

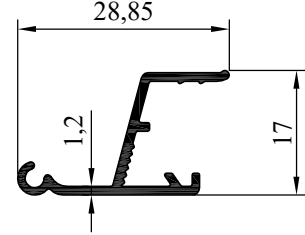

NO : 4689
AGIRLIK : 0.196 kg/m

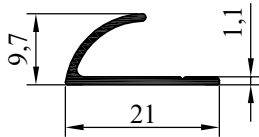

NO : 4667
AGIRLIK : 0.101 kg/m

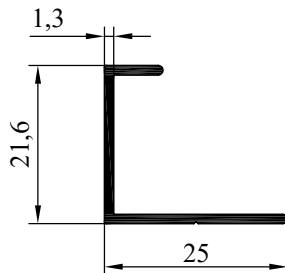

NO:6538 AĞIRLIK: 182 gr/m

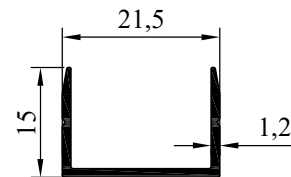

NO:7907 AĞIRLIK: 154gr/m

MOBİLYA PROFİLLERİ

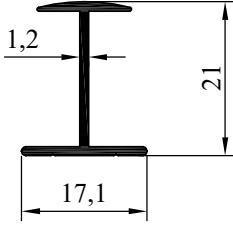

NO:6964
AĞIRLIK:150 gr/m

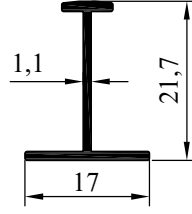

NO: 7906
AĞIRLIK: 136 gr/m

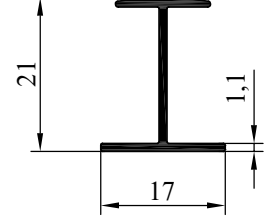

NO:6661
AĞIRLIK:146 gr/m

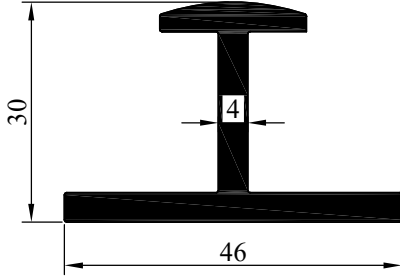

NO:7895
AĞIRLIK: 920 gr/m

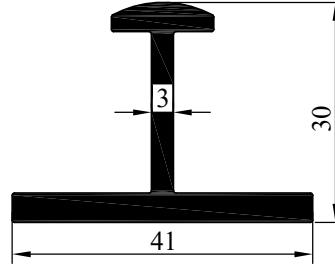

NO:8050
AĞIRLIK: 751 gr/m

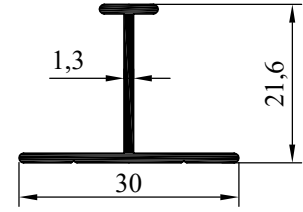

NO:6537
AĞIRLIK:198 gr/m

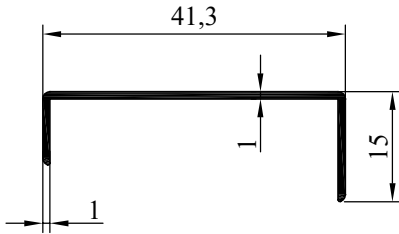

NO : 5841
AĞIRLIK : 173 gr/m

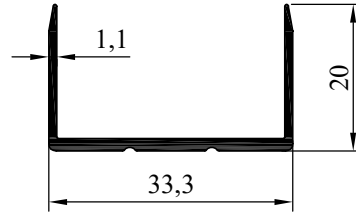

NO : 5214
AGIRLIK : 0.251 kg/m

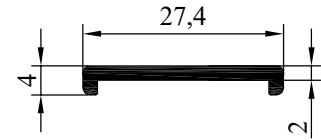

NO : 4626
AGIRLIK : 0.167 kg/m

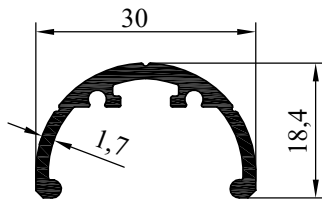

NO : 4280
AGIRLIK : 0.303 kg/m

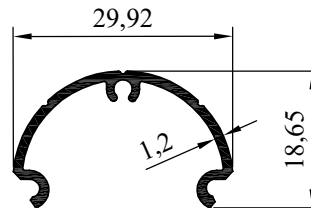

NO : 4281
AGIRLIK : 0.204 kg/m

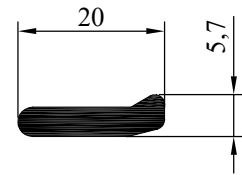

NO : 4831
AGIRLIK : 0.215 kg/m

MOBİLYA PROFİLLERİ

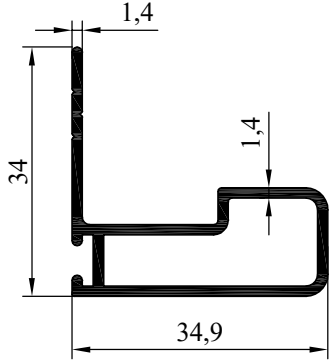

NO : 5735 AĞIRLIK : 447 gr/m

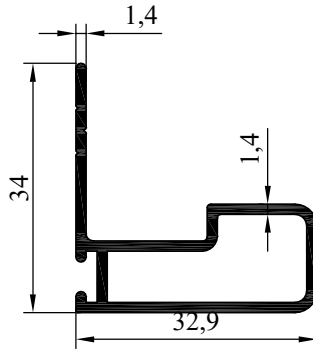

NO : 5736 AĞIRLIK : 432 gr/m

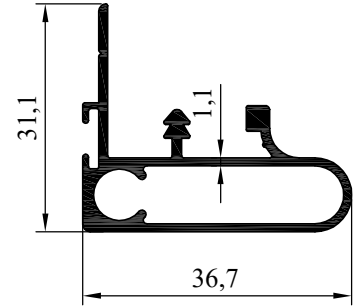

NO : 4818 AĞIRLIK : 0.457 kg/m

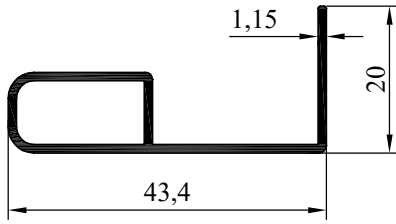

NO:6532 AĞIRLIK: 301 gr/m

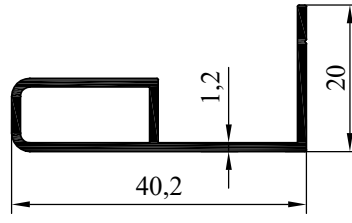

NO:6683 AĞIRLIK: 300 gr/m

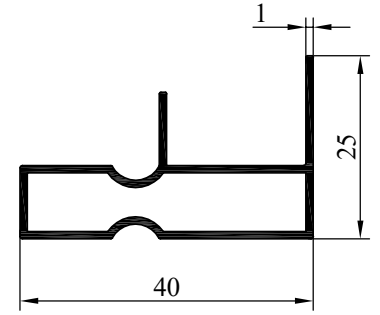

NO:6535 AĞIRLIK: 335 gr/m

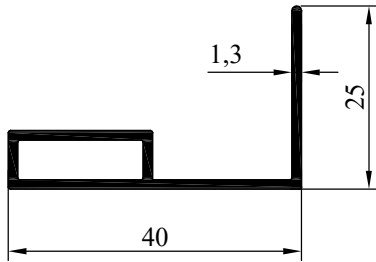

NO:6536 AĞIRLIK: 331 gr/m

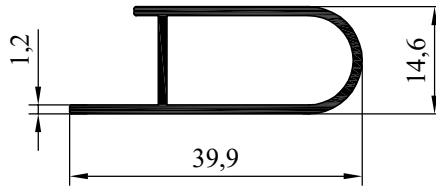

NO : 6028 AĞIRLIK : 292 gr/m

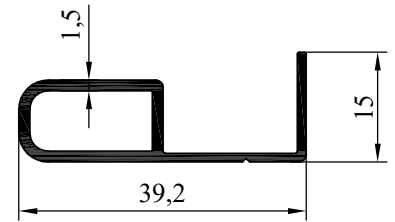

NO : 6065 AĞIRLIK : 322 gr/m

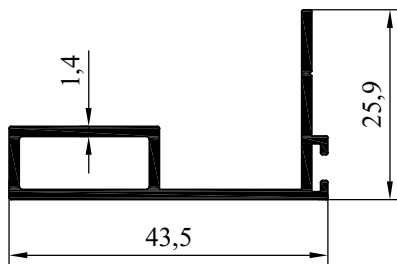

NO:6622 AĞIRLIK:403 gr/m

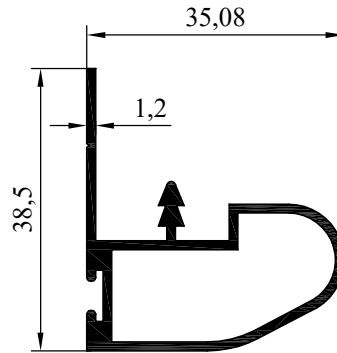

NO : 1590
AĞIRLIK : 0.472 kg/m

MOBİLYA PROFİLLERİ

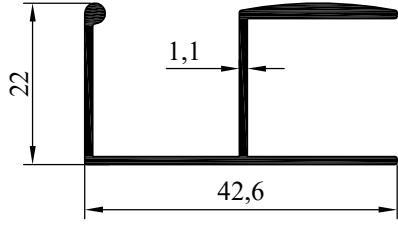

NO:6546 AĞIRLIK:358 gr/m

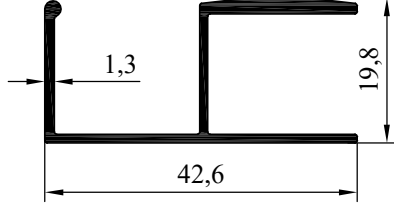

NO:6647 AĞIRLIK:367 gr/m

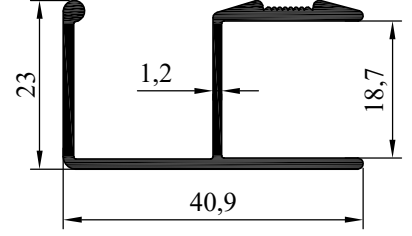

NO : 3389 AĞIRLIK : 0.416 kg/m

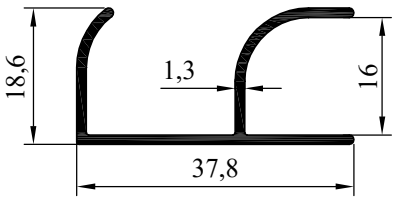

NO : 3390 AĞIRLIK : 0.295 kg/m

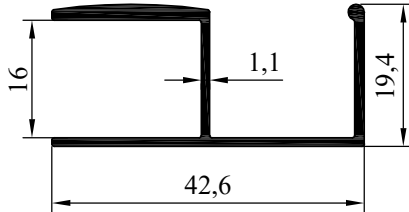

NO : 3402 AĞIRLIK : 0.366 kg/m

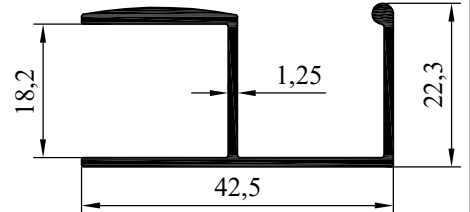

NO : 3958 AĞIRLIK : 0.397 kg/m

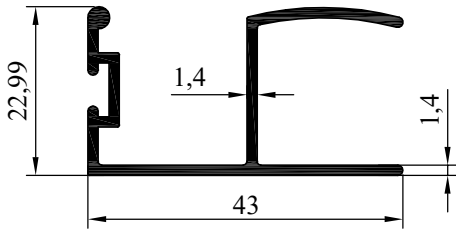

NO : 5713 AĞIRLIK : 439 gr/m

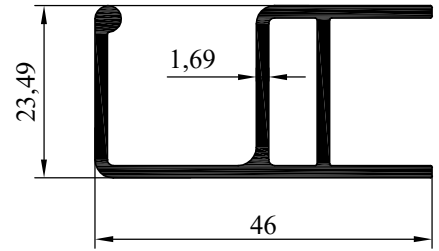

NO:753 AĞIRLIK:614 gr/m

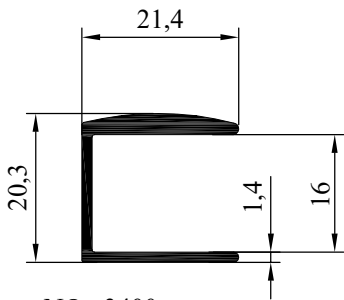

NO : 3400
AĞIRLIK : 0.281 kg/m

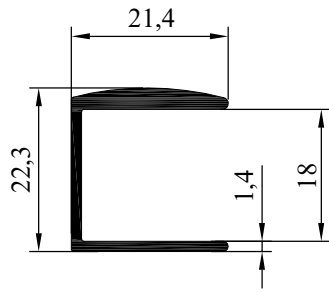

NO : 3401
AĞIRLIK : 0.289 kg/m

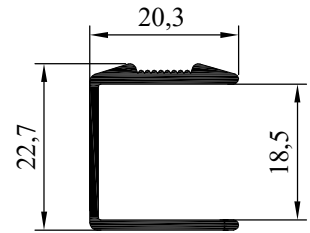

NO : 3388
AĞIRLIK : 0.242 kg/m

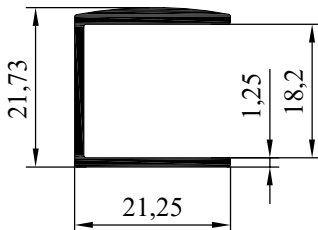

NO : 3955
AĞIRLIK : 0.245 kg/m

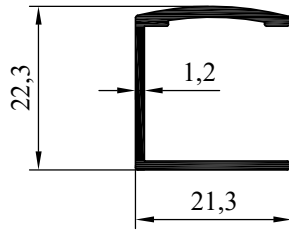

NO:6963
AĞIRLIK: 222 gr/m

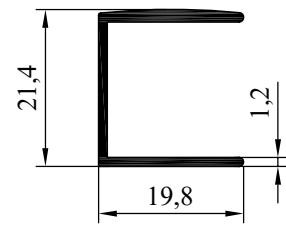

NO:6545
AĞIRLIK: 206 gr/m

MOBİLYA PROFİLLERİ

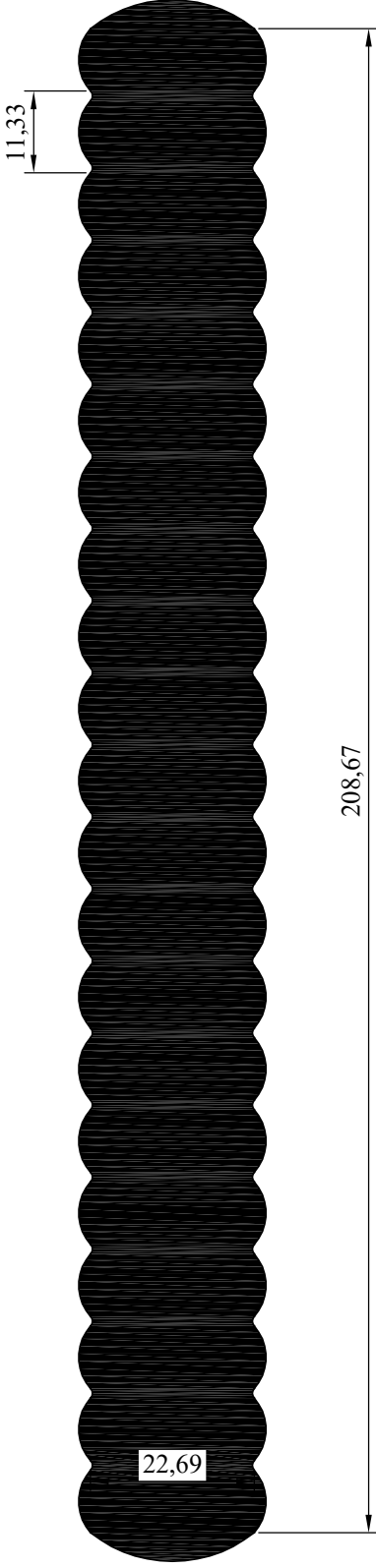

NO:7860 AĞIRLIK: 14208 gr/m

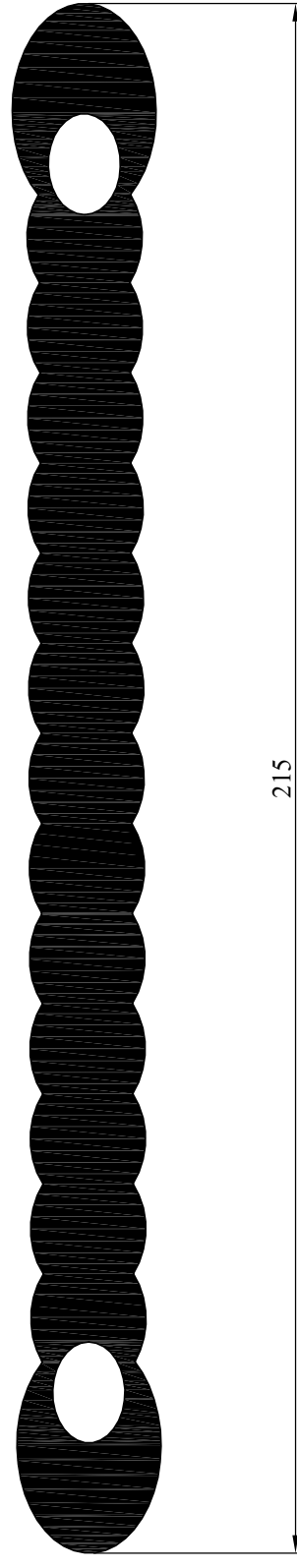

NO:7861 AĞIRLIK: 8300 gr/m

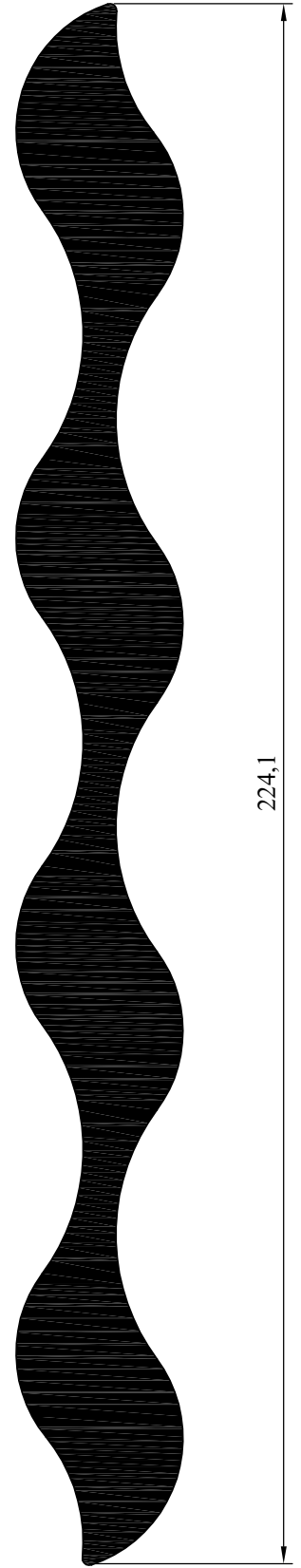

NO:7864 AĞIRLIK: 8340 gr/m

MOBİLYA PROFİLLERİ

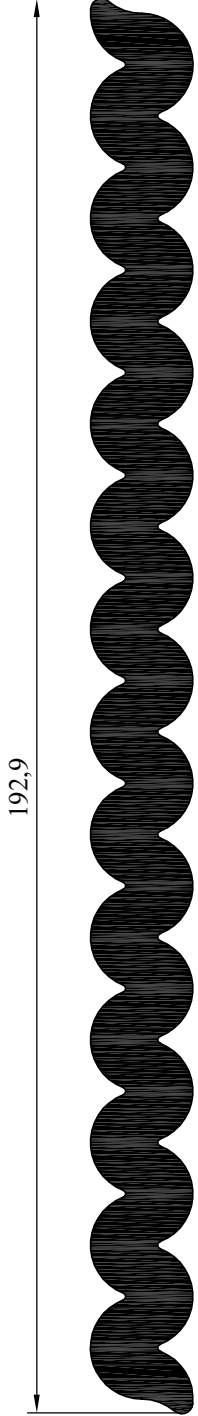

NO:7863
AĞIRLIK: 5686 gr/m

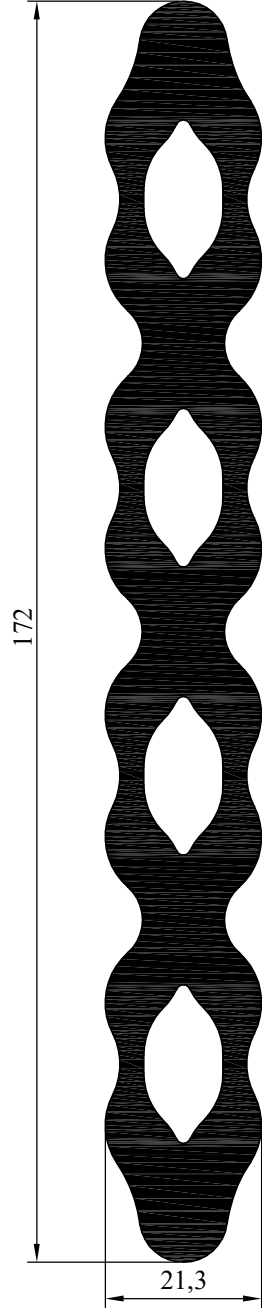

NO:7668
AĞIRLIK: 6233 gr/m

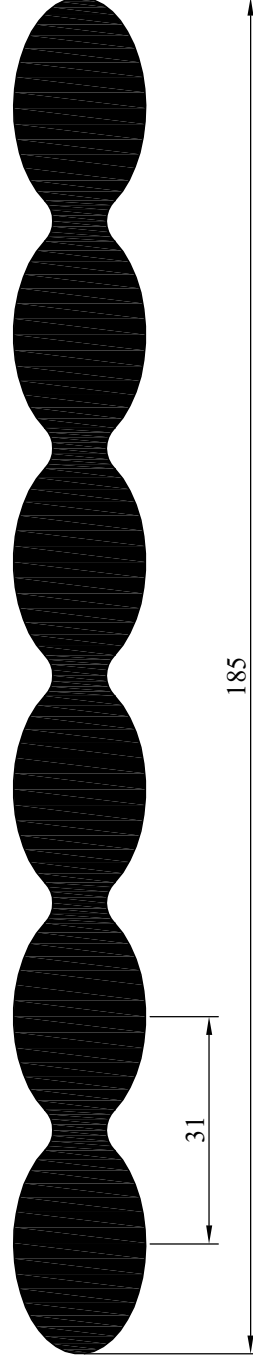

NO:7862
AĞIRLIK: 7074 gr/m

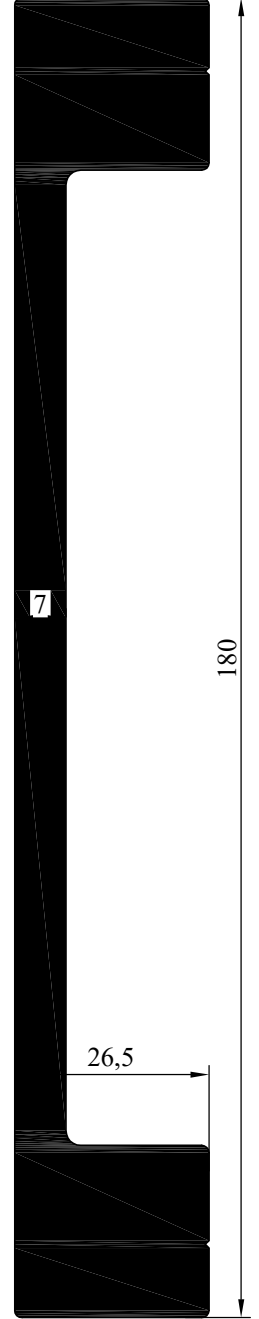

NO:7725
AĞIRLIK: 5878 gr/m

MOBİLYA PROFİLLERİ

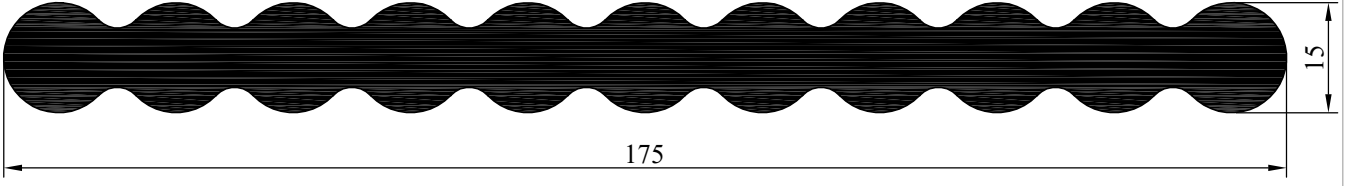

NO:7825 AĞIRLIK: 5674 gr/m

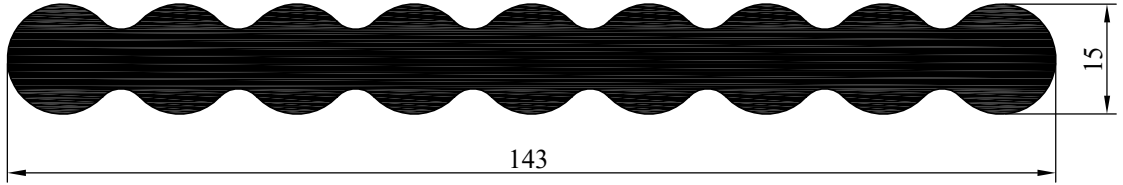

NO:7826 AĞIRLIK: 4635 gr/m

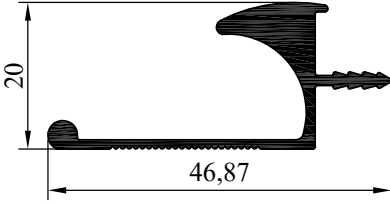

NO:8080 AĞIRLIK: 435 gr/m

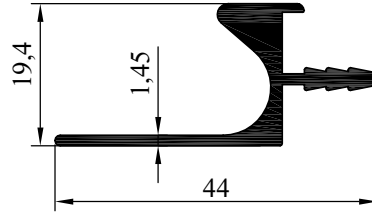

NO:7732 AĞIRLIK: 416 gr/m

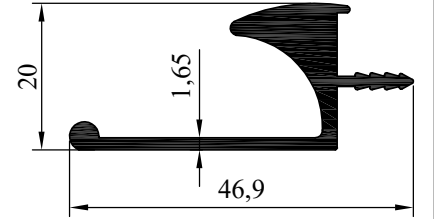

NO:7299 AĞIRLIK:540 gr/m

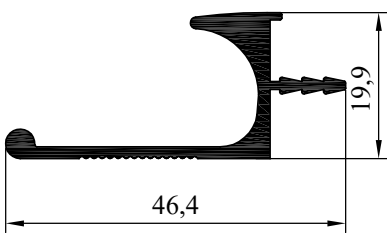

NO:7499 AĞIRLIK:411 gr/m

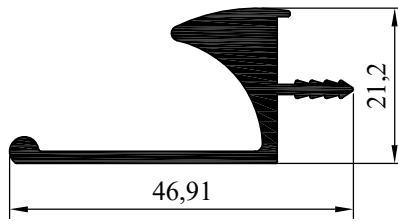

NO : 4616 AĞIRLIK : 0.575 kg/m

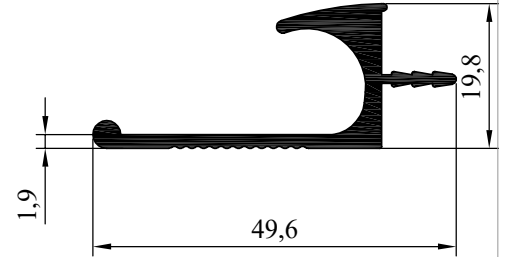

NO : 5476 AĞIRLIK : 493 gr/m

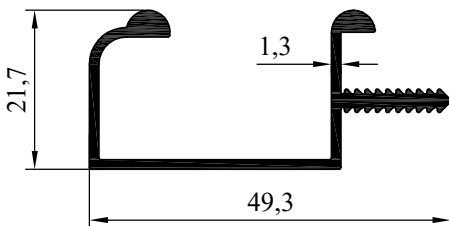

NO : 5123
AĞIRLIK : 0.437 kg/m

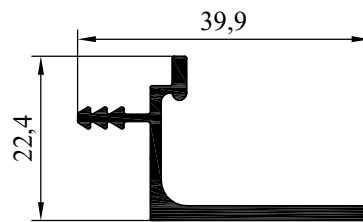

NO : 4031
AĞIRLIK : 0.318 kg/m

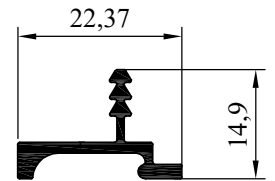

NO : 4032
AĞIRLIK : 0.182 kg/m

MOBİLYA PROFİLLERİ

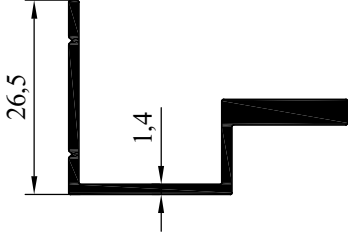

NO:6662 AĞIRLIK:371 gr/m

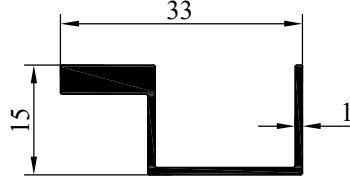

NO:7905 AĞIRLIK: 262 gr/m

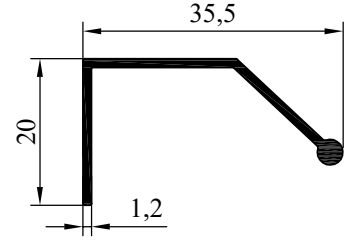

NO: 6693 AĞIRLIK: 207 gr/m

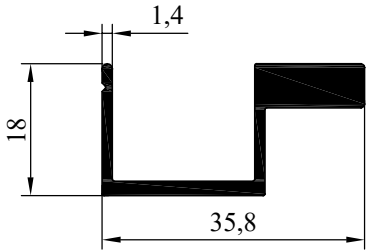

NO:6624 AĞIRLIK: 461 gr/m

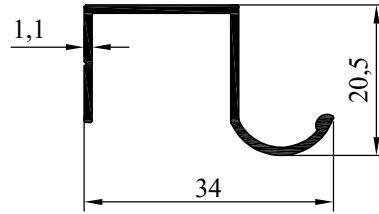

NO:6555 AĞIRLIK:205 gr/m

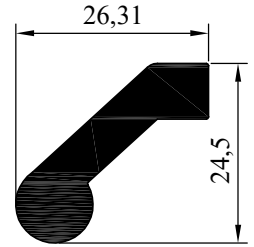

NO:7955 AĞIRLIK: 654 gr/m

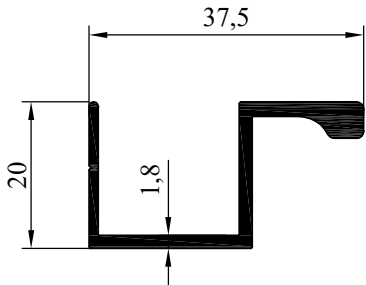

NO:6825 AĞIRLIK: 389 gr/m

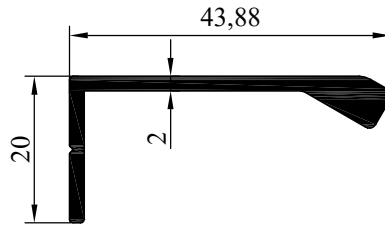

NO:7832 AĞIRLIK: 415 gr/m

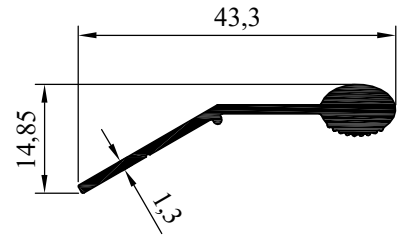

NO : 3777 AĞIRLIK : 0.277 kg/m

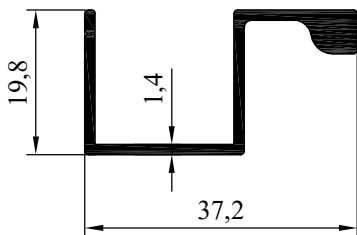

NO:6935 AĞIRLIK: 355 gr/m

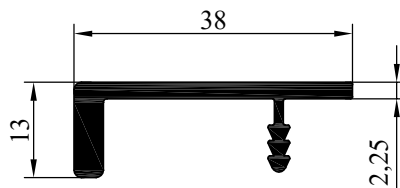

NO : 4990 AĞIRLIK : 0.397 kg/m

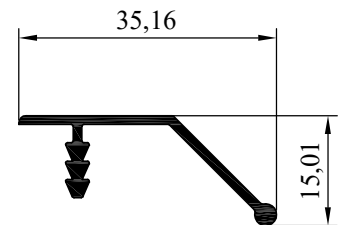

NO : 3927 AĞIRLIK : 0.196 kg/m

MOBİLYA PROFİLLERİ

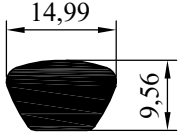

NO:7833 AĞIRLIK: 316 gr/m

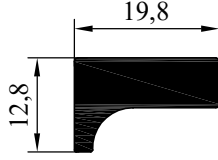

NO:7834 AĞIRLIK: 421 gr/m

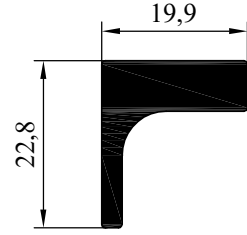

NO:7835 AĞIRLIK: 512 gr/m

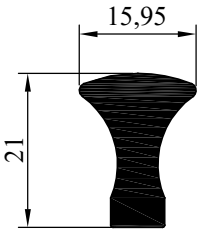

NO:7836 AĞIRLIK: 478 gr/m

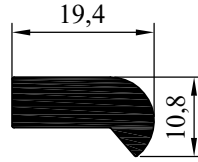

NO:7837 AĞIRLIK: 377 gr/m

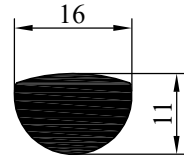

NO:7838 AĞIRLIK:381 gr/m

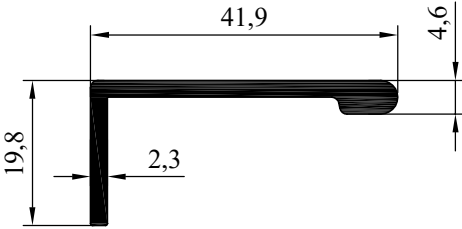

NO : 5025 AĞIRLIK : 0.413 kg/m

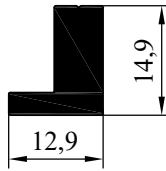

NO:7065 AĞIRLIK: 321 gr/m

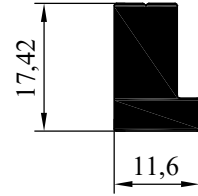

NO : 5366
AĞIRLIK : 0.442 kg/m

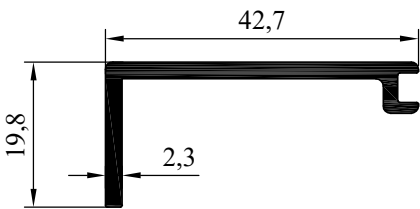

NO:6451 AĞIRLIK:397 gr/m

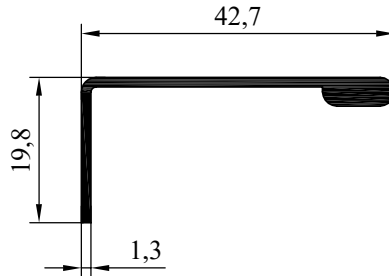

NO:6539 AĞIRLIK:275 gr/m

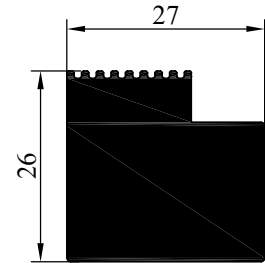

NO: 7866 AĞIRLIK :1685 gr/m

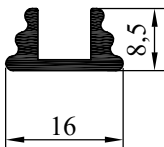

NO:7830 AĞIRLIK: 153 gr/m

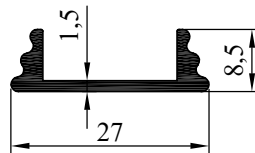

NO:7831 AĞIRLIK: 195 gr/m

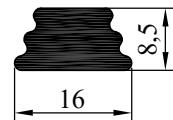

NO:7829 AĞIRLIK: 289 gr/m

MOBİLYA PROFİLLERİ

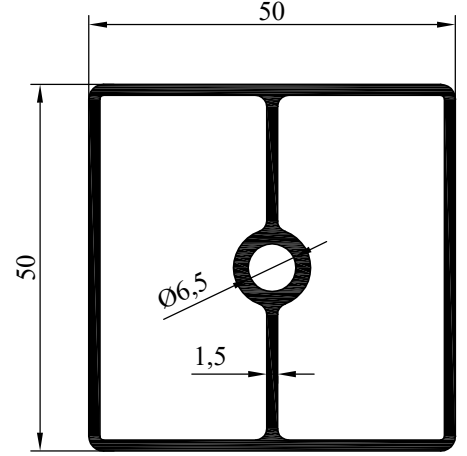
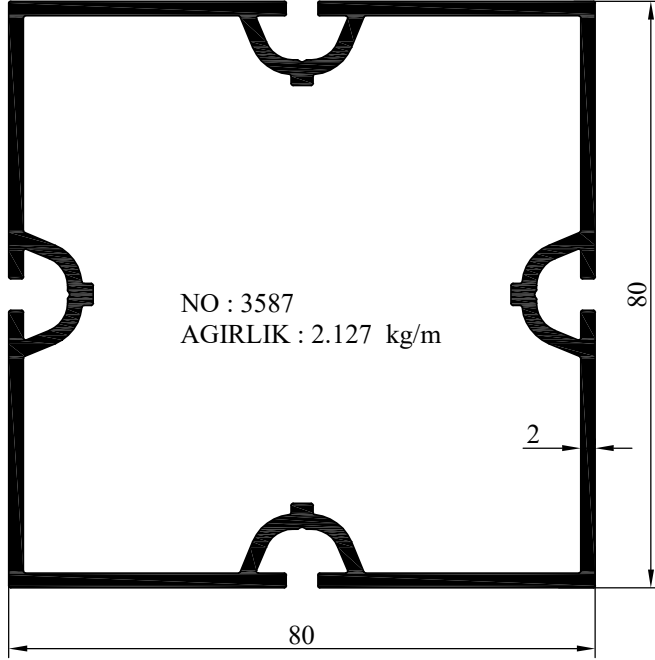

NO : 2969
AGIRLIK : 1.075 kg/m

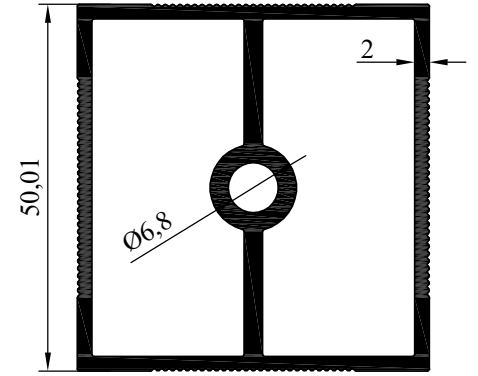
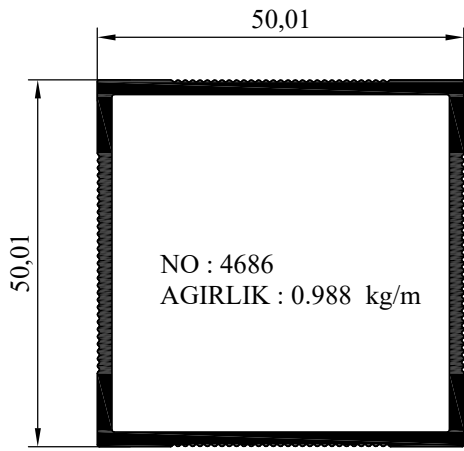

NO : 4685
AGIRLIK : 1.398 kg/m

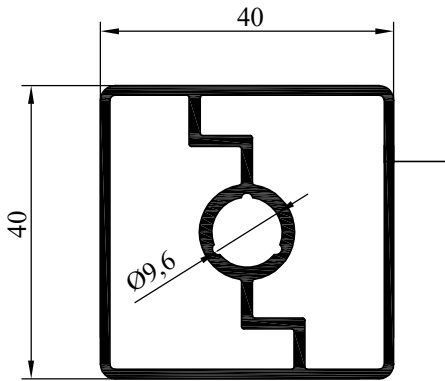

NO : 4993
AGIRLIK : 0.851 kg/m

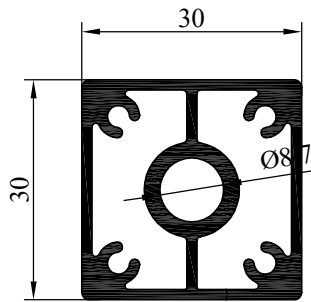

NO : 4027
AGIRLIK : 0.934 kg/m

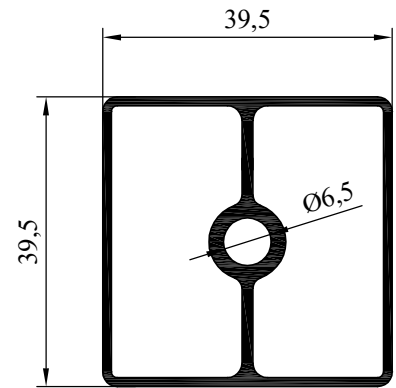

NO : 3151
AGIRLIK : 0.753 kg/m

MOBİLYA PROFİLLERİ

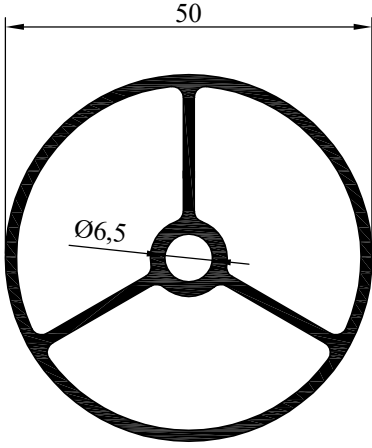

NO : 2970
AGIRLIK : 1.000 kg/m

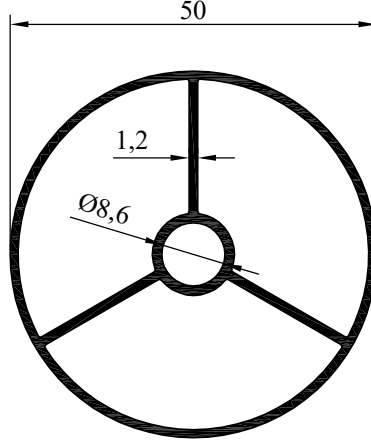

NO : 3538
AGIRLIK : 0.744 kg/m

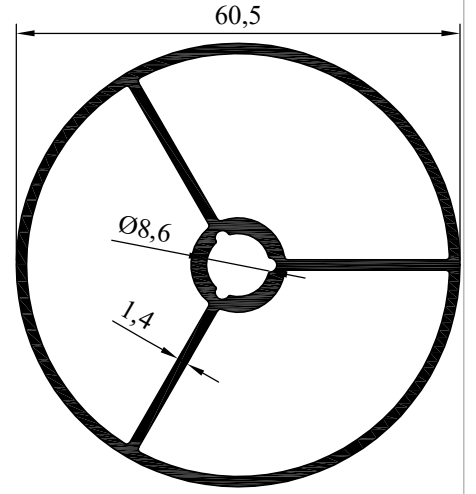

NO : 5104
AGIRLIK : 1.140 kg/m

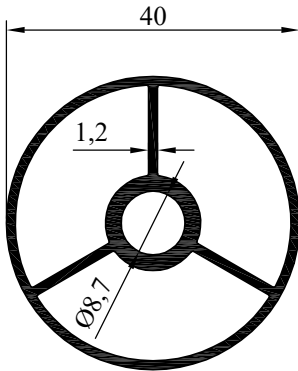

NO : 4024
AGIRLIK : 0.712 kg/m

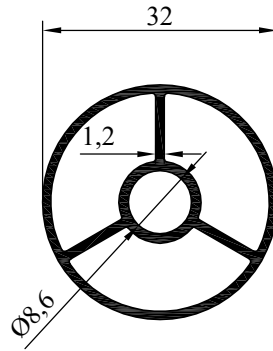

NO : 3539
AGIRLIK : 0.489 kg/m

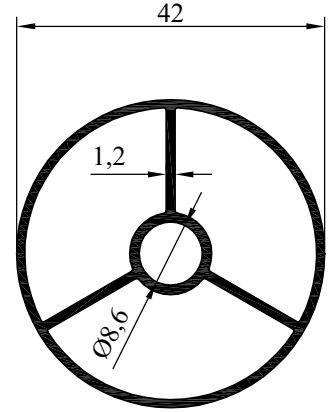

NO : 4214
AGIRLIK : 0.630 kg/m

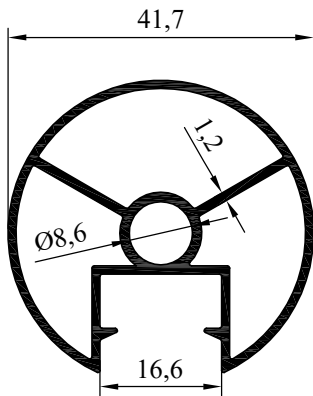

NO : 3537
AGIRLIK : 0.657 kg/m

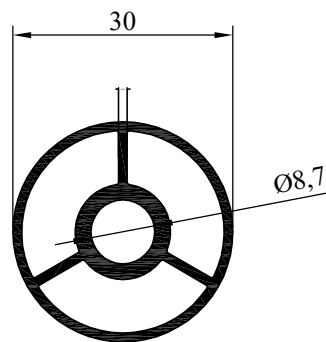

NO : 4023
AGIRLIK : 0.562 kg/m

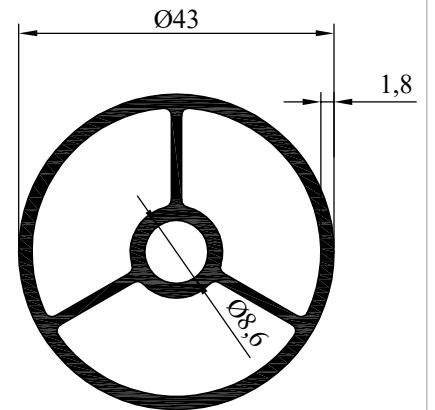

NO : 6030
AGIRLIK : 968 gr/m

MOBİLYA PROFİLLERİ

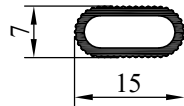
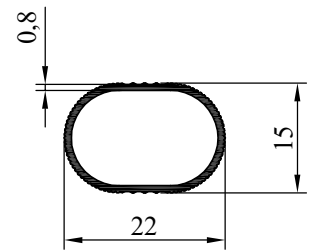
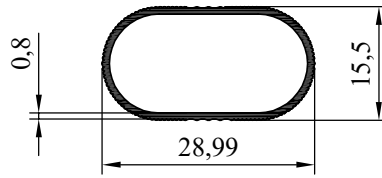
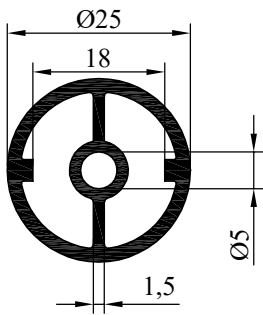
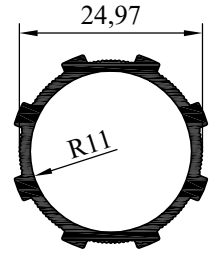
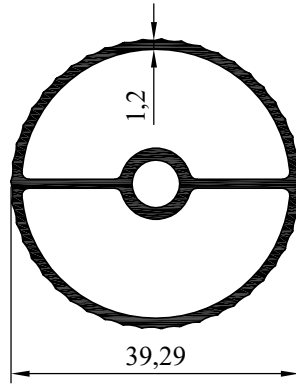
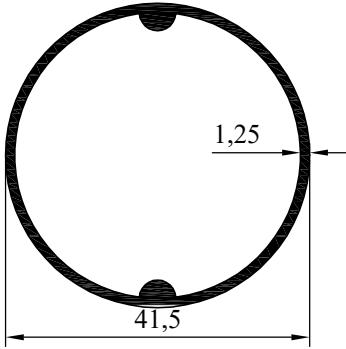
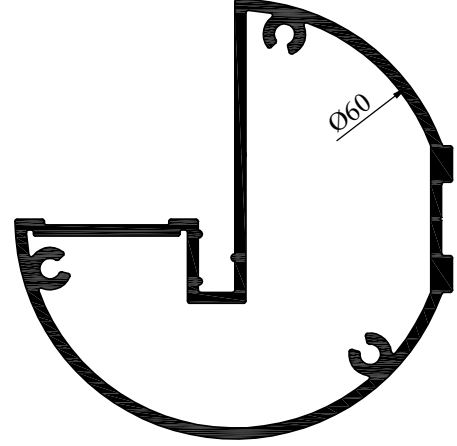
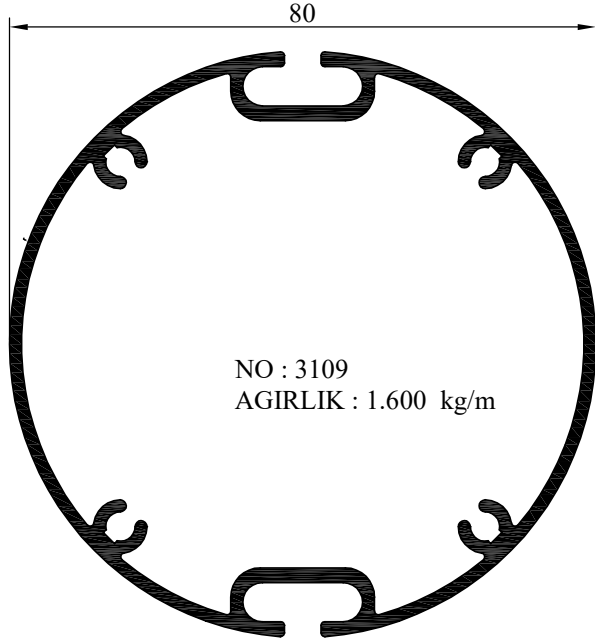

MOBİLYA PROFİLLERİ

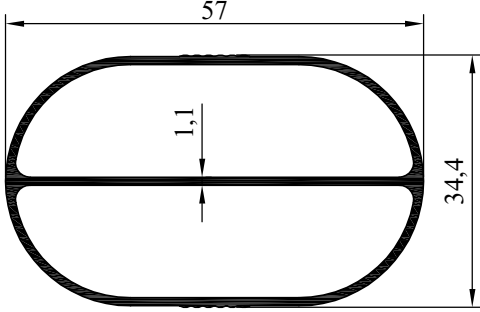

NO:6658 AĞIRLIK:627.5gr/m

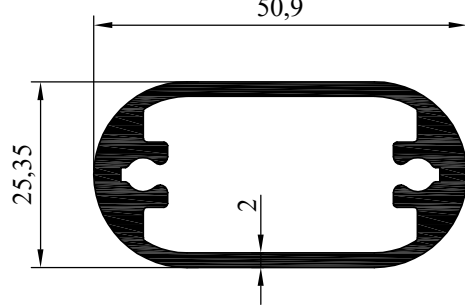

NO : 3108 AĞIRLIK : 1.031 kg/m

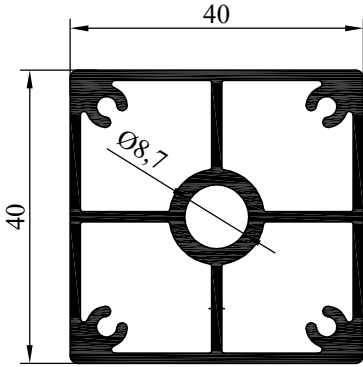

NO : 4028
AĞIRLIK : 1.210 kg/m

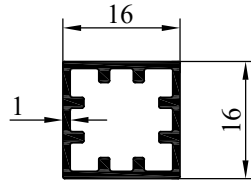

NO : 3546
AĞIRLIK : 0.224 kg/m

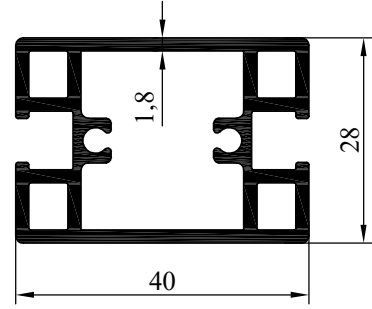

NO : 3663
AĞIRLIK : 0.954 kg/m

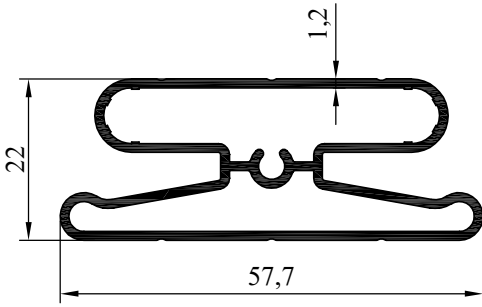

NO:6620 AĞIRLIK:733 gr/m

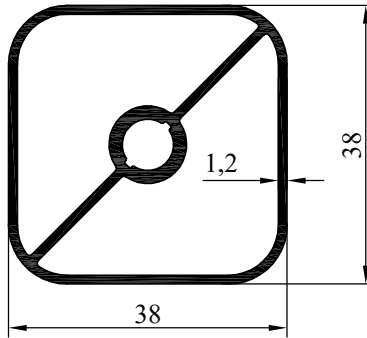

NO : 6289
AĞIRLIK : 679 gr/m

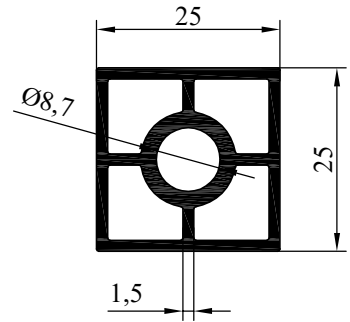

NO : 4033
AĞIRLIK : 0.652 kg/m

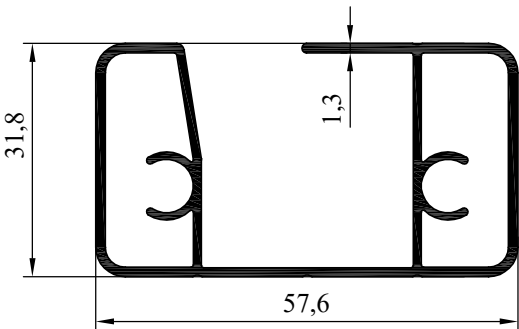

NO:6621 AĞIRLIK: 779 gr/m

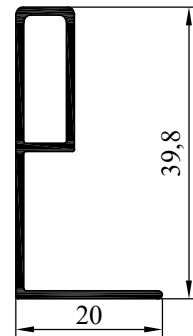

NO:10909 AĞIRLIK: 0.267 gr/m

MOBİLYA PROFİLLERİ

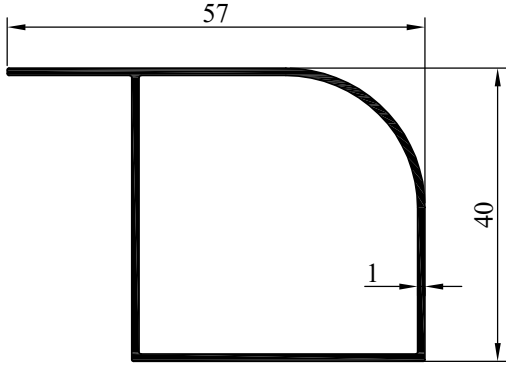

NO : 4780 AGIRLIK : 0.446 kg/m

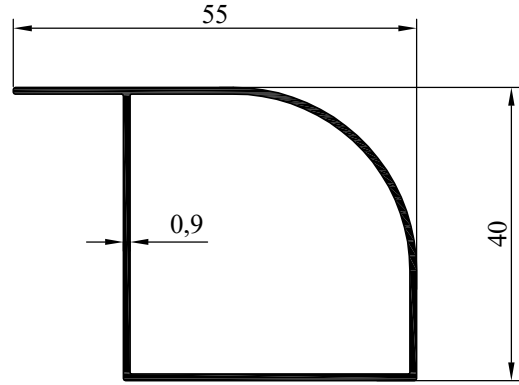

NO : 5431 AGIRLIK : 0.392 kg/m

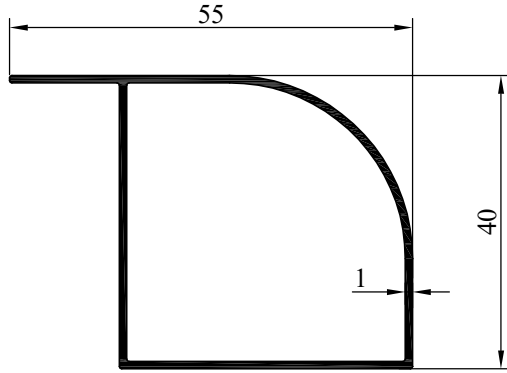

NO : 2674 AGIRLIK : 0.432 kg/m

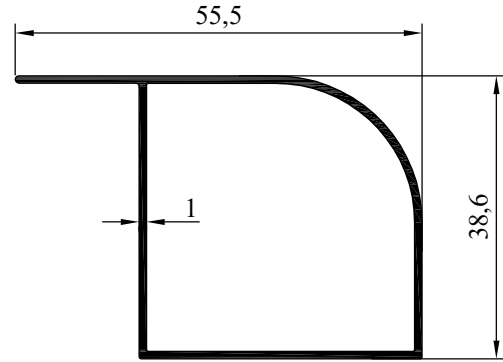

NO : 5814 AGIRLIK : 0.429 kg/m

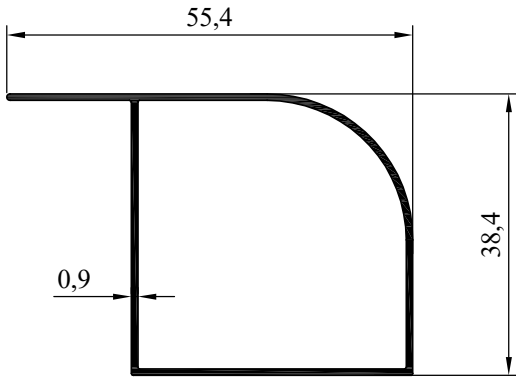

NO:6698 AĞIRLIK: 386 gr/m

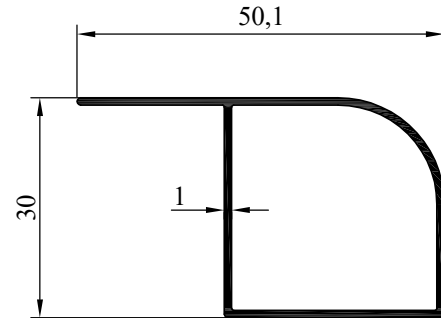

NO : 4802 AGIRLIK : 0.351 kg/m

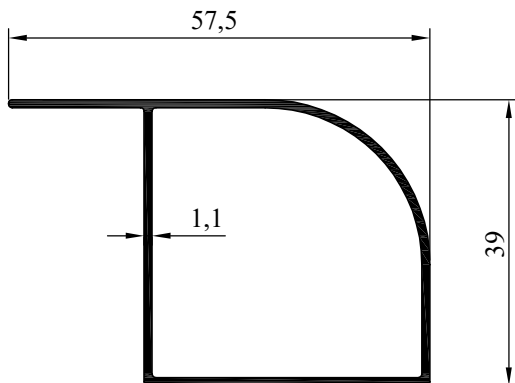

NO : 4284 AGIRLIK : 0.477 kg/m

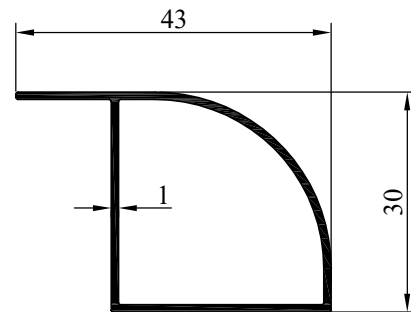

NO : 4781 AGIRLIK : 0.321 kg/m

MOBİLYA PROFİLLERİ

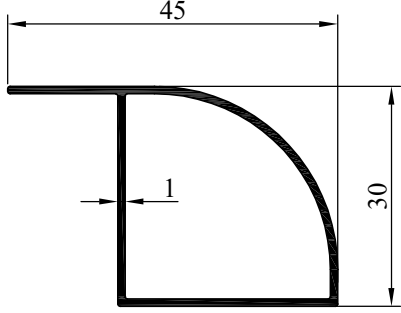

NO:2722 AĞIRLIK : 0.325 kg/m

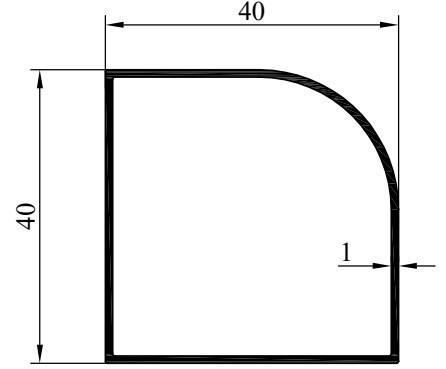

NO : 4867 AĞIRLIK : 0.400 kg/m

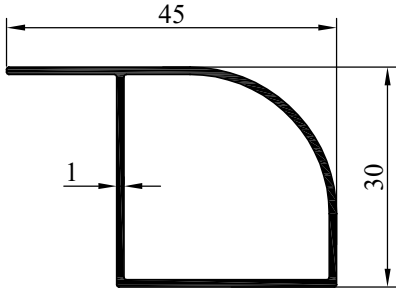

NO:3245 AĞIRLIK: 332 gr/m

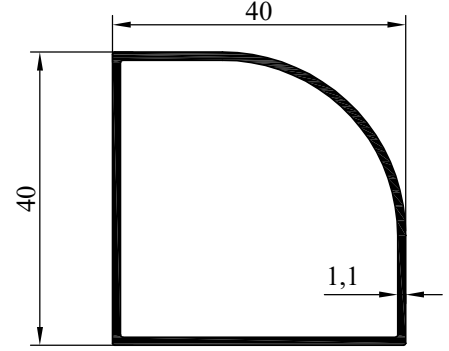

NO : 2675 AĞIRLIK : 0.429 kg/m

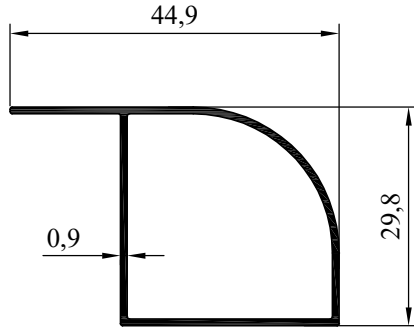

NO:6697 AĞIRLIK: 298 gr/m

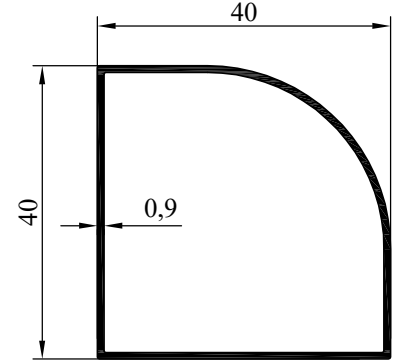

NO : 5432 AĞIRLIK :0.355 kg/m

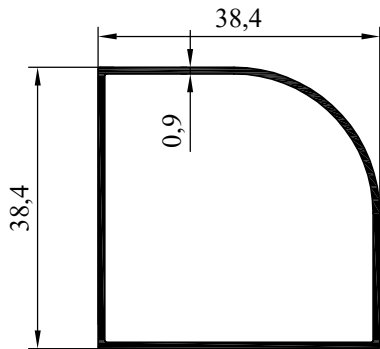

NO:6699 AĞIRLIK: 344 gr/m

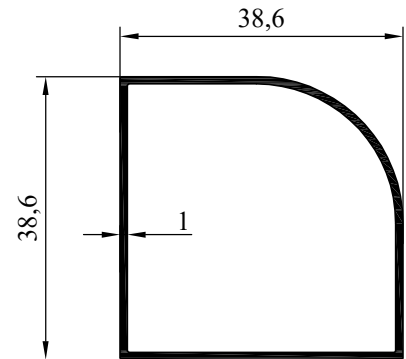

NO : 5415 AĞIRLIK :0.384 kg/m

MOBİLYA PROFİLLERİ

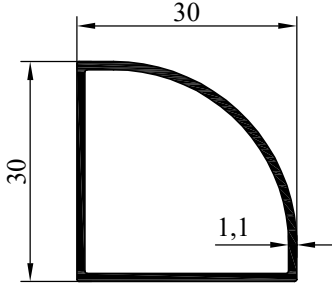

NO : 2676 AĞIRLIK : 0.312 kg/m

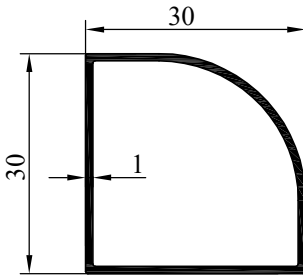

NO : 3458 AĞIRLIK : 0.290 kg/m

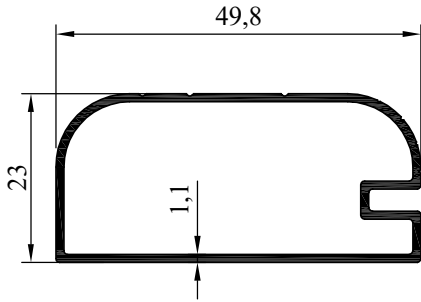

NO : 4285 AĞIRLIK : 0.435 kg/m

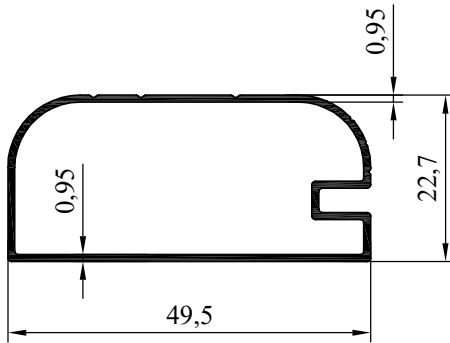

NO:6696 AĞIRLIK: 375 gr/m

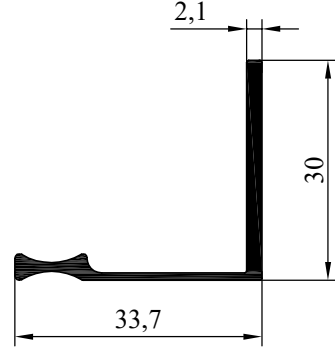

NO:6776
AĞIRLIK: 0.289 gr/m

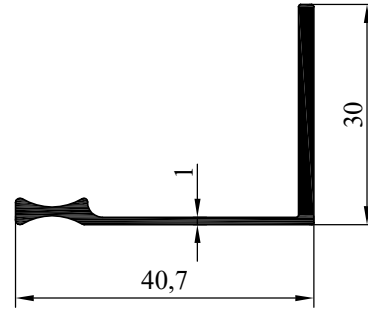

NO:6777
AĞIRLIK: 0.308 gr/m

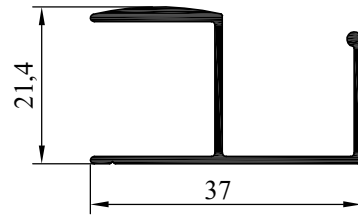

NO:8826
AĞIRLIK: 0.280 gr/m

MOBİLYA PROFİLLERİ

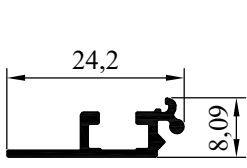

NO : 3236
AGIRLIK : 0.130 kg/m

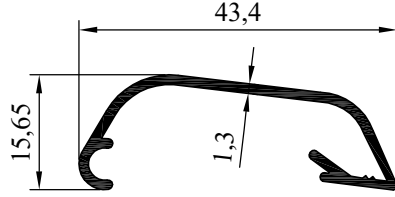

NO : 2911
AGIRLIK : 0.264 kg/m

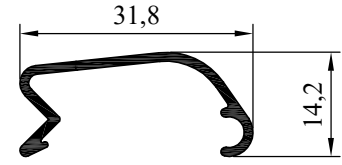

NO : 3286
AGIRLIK : 0.191 kg/m

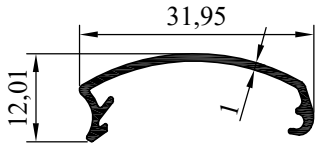

NO : 3235
AGIRLIK : 0.143 kg/m

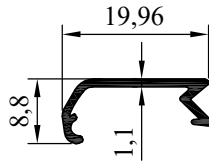

NO : 2922
AGIRLIK : 0.105 kg/m

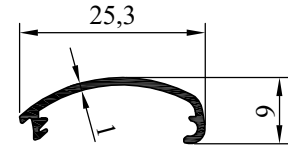

NO : 3287
AGIRLIK : 0.103 kg/m

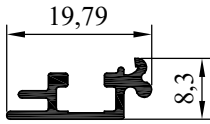

NO : 2919
AGIRLIK : 0.131 kg/m

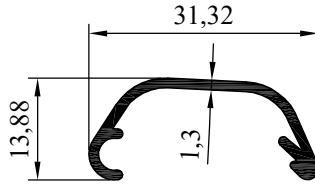

NO : 2917
AGIRLIK : 0.200 kg/m

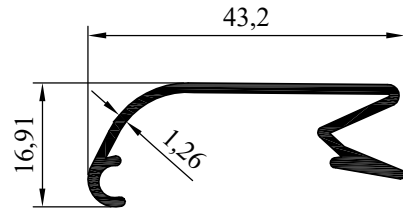

NO : 2921
AGIRLIK : 0.302 kg/m

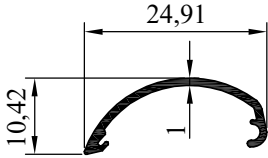

NO : 2920
AGIRLIK : 0.101 kg/m

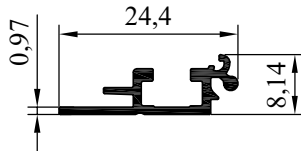

NO : 3288
AGIRLIK : 0.135 kg/m

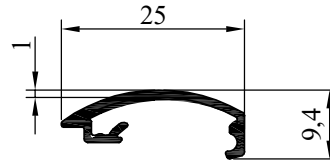

NO : 5514
AGIRLIK : 124 gr/m

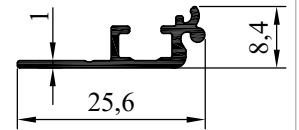

NO : 5513
AGIRLIK : 130 gr/m

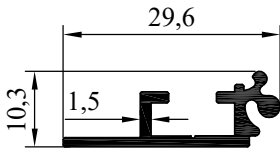

NO : 4212
AGIRLIK : 0.213 kg/m

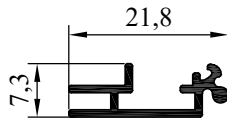

NO : 3664
AGIRLIK : 0.130 kg/m

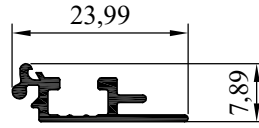

NO:7722
AGIRLIK: 130 gr/m

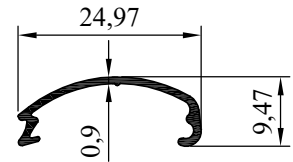

NO:7721
AGIRLIK: 103 gr/m

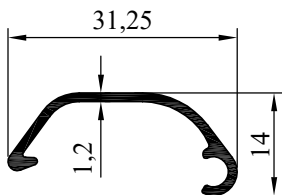

NO : 4316
AGIRLIK : 0.165 kg/m

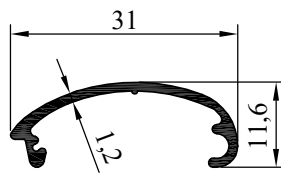

NO : 4213
AGIRLIK : 0.165 kg/m

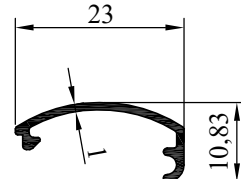

NO : 3665
AGIRLIK : 0.103 kg/m

MOBİLYA PROFİLLERİ

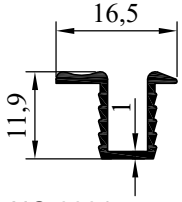

NO:6664
AĞIRLIK:108 gr/m

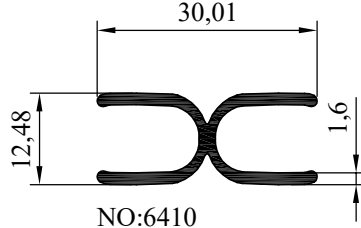

NO:6410
AĞIRLIK:281 gr/m

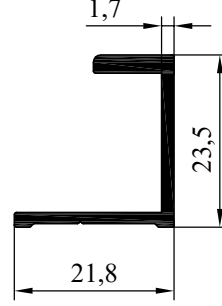

NO:6944
AĞIRLIK: 257 gr/m

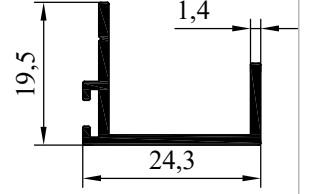

NO:6623
AĞIRLIK: 262 gr/m

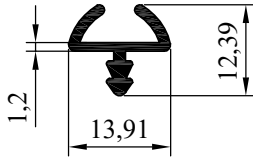

NO:6965
AĞIRLIK: 132 gr/m

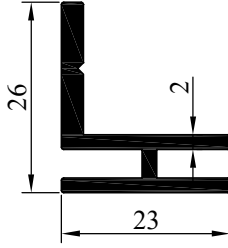

NO: 7896
AĞIRLIK:416 gr/m

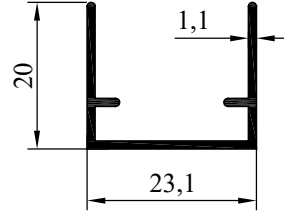

NO:6551
AĞIRLIK: 200 gr/m

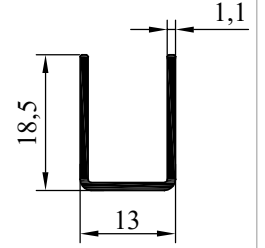

NO:6824
AĞIRLIK: 141 gr/m

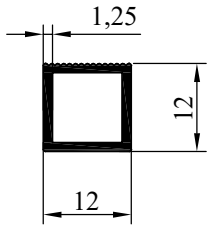

NO:7220
AĞIRLIK:142 gr/m

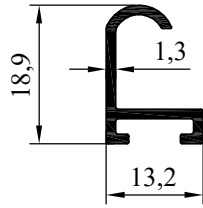

NO: 6626
AĞIRLIK:156 gr/m

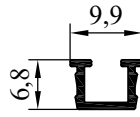

NO:7871
AĞIRLIK: 65 gr/m

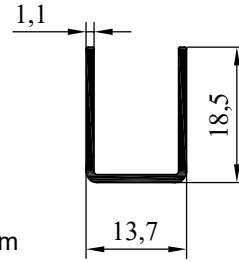

NO:6945
AĞIRLIK:142 gr/m

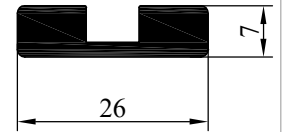

NO:7827
AĞIRLIK: 392 gr/m

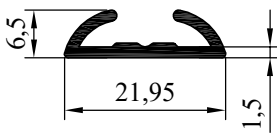

NO: 6756
AĞIRLIK:159 gr/m

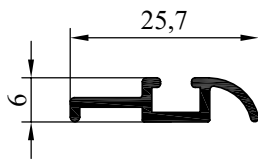

NO:6746
AĞIRLIK:141 gr/m

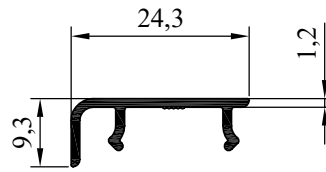

NO : 5782
AĞIRLIK : 143 gr/m

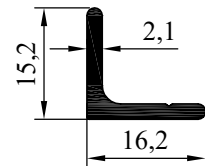

NO: 7408
AĞIRLIK:168 gr/m

MOBİLYA PROFİLLERİ

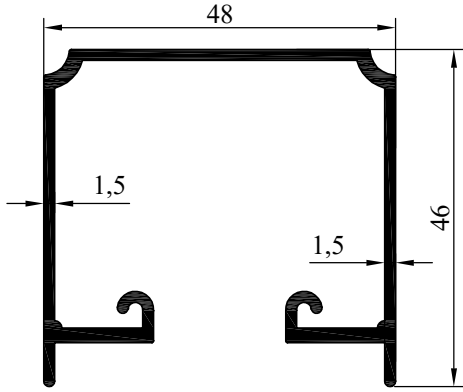

NO:6757
AĞIRLIK: 772 gr/m

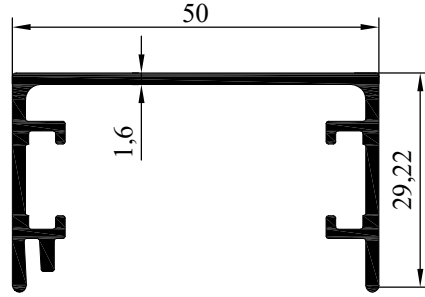

NO : 3107
AĞIRLIK : 0.625 kg/m

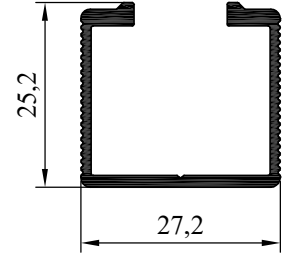

NO:7409
AĞIRLIK:351 gr/m

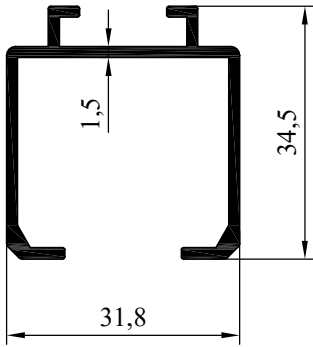

NO:7514
AĞIRLIK:478 gr/m

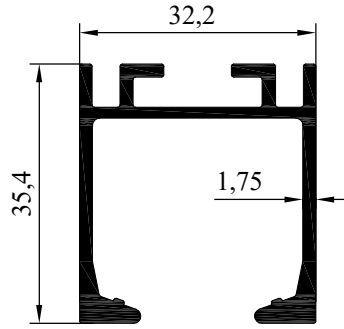

NO : 3396
AĞIRLIK : 0.665 kg/m

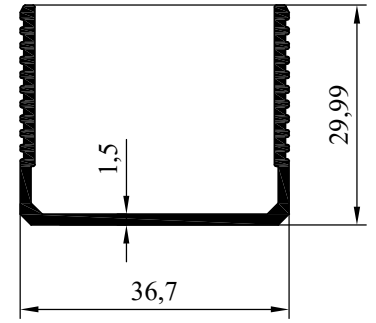

NO:7747
AĞIRLIK: 411 gr/m

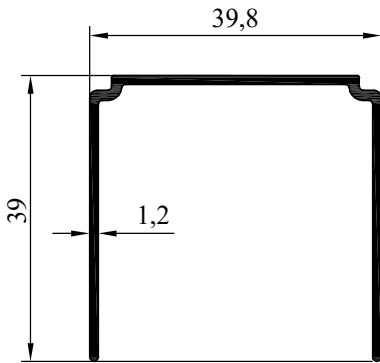

NO:6754
AĞIRLIK:375 gr/m

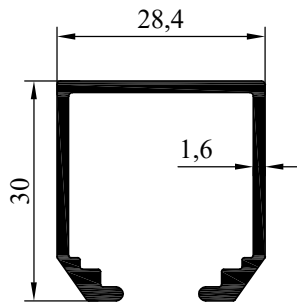

NO : 3391
AĞIRLIK : 0.446 kg/m

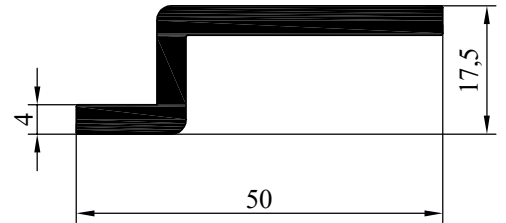

NO : 4992
AĞIRLIK : 0.682 kg/m

MOBİLYA PROFİLLERİ

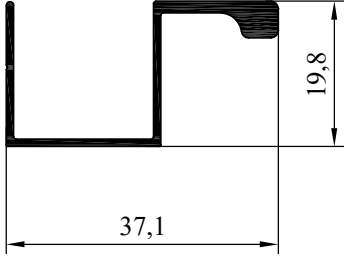

13048 - 276 gr/m

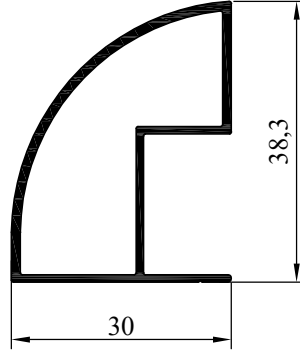

13049 - 392 gr/m

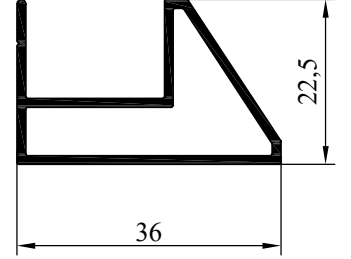

13050 - 378 gr/m

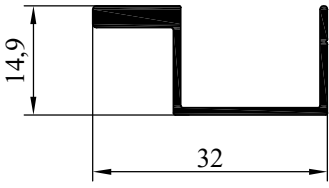

13110 - 222 gr/m

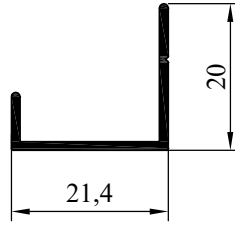

13111 - 151 gr/m

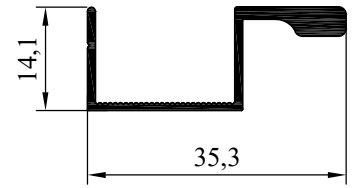

13261 - 246 gr/m

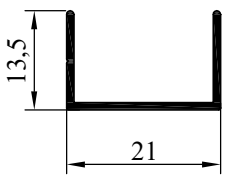

13262 - 124 gr/m

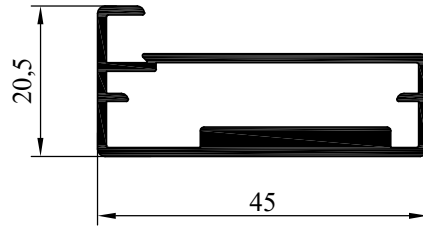

13282 - 621 gr/m

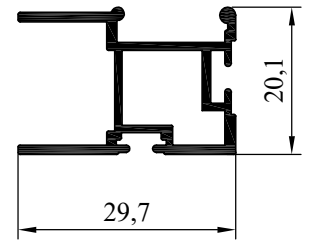

13299 - 349 gr/m

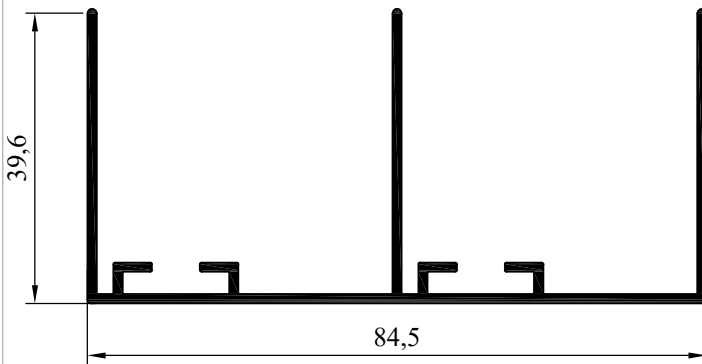

14526 - 821 gr/m

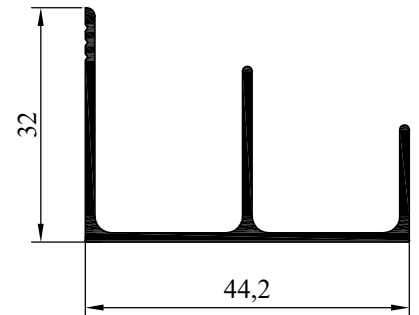

8200 - 404 gr/m

MOBİLYA PROFİLLERİ

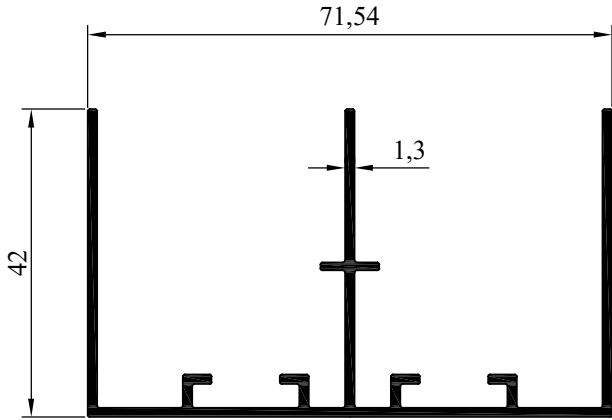

8962 - 800 gr/m

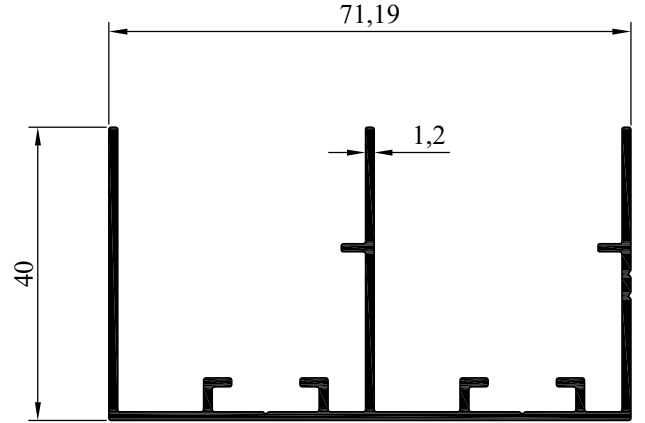

8963 - 721 gr/m

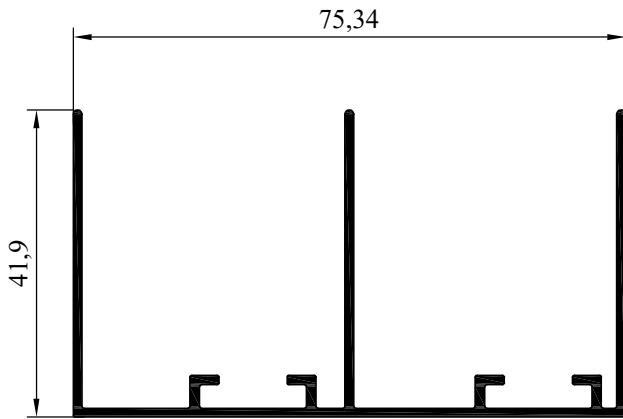

10767 - 739 gr/m

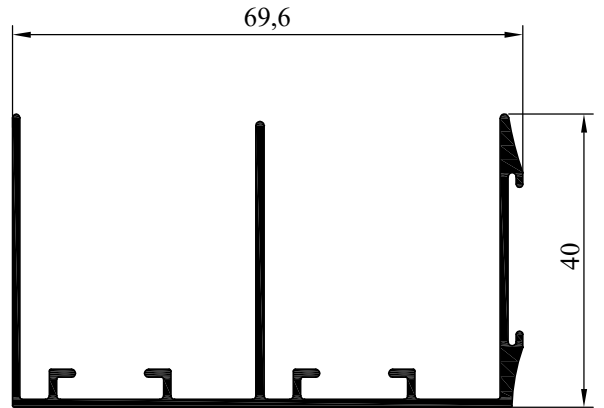

10834 - 662 gr/m

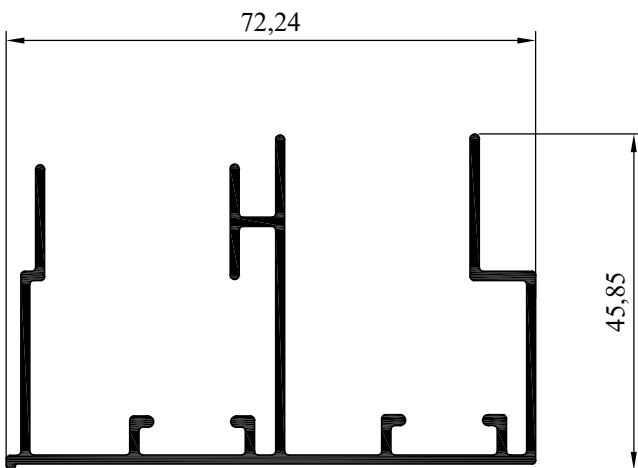

9568 - 880 gr/m

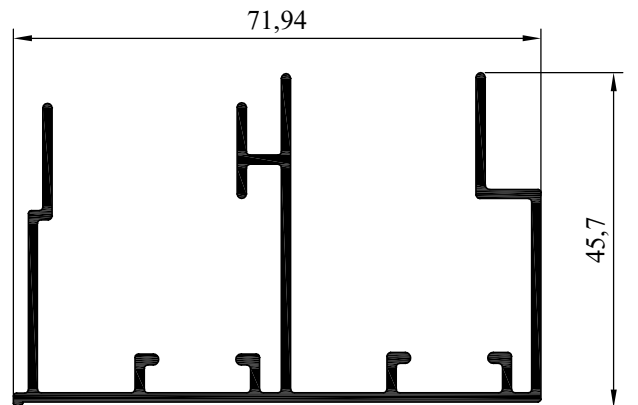

10505 - 868 gr/m

MOBİLYA PROFİLLERİ

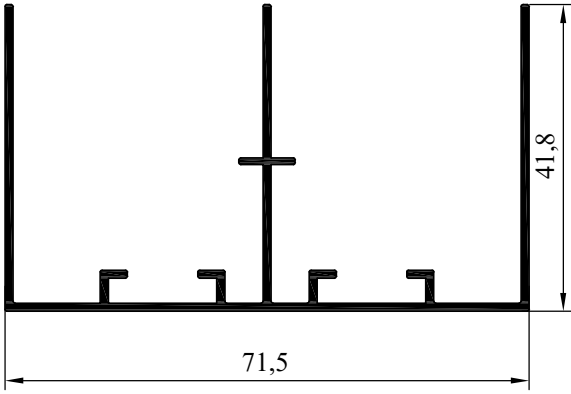

11897 - 675 gr/m

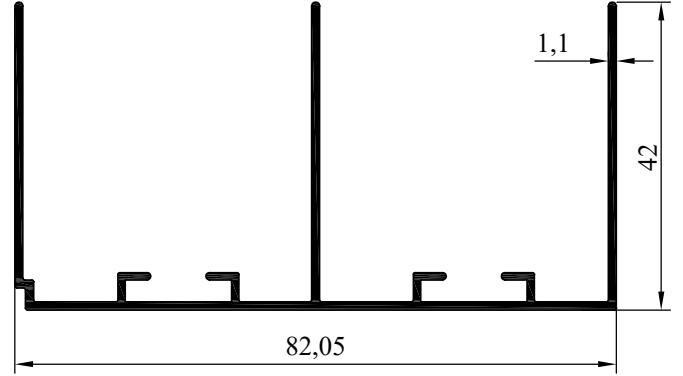

12620 - 689 gr/m

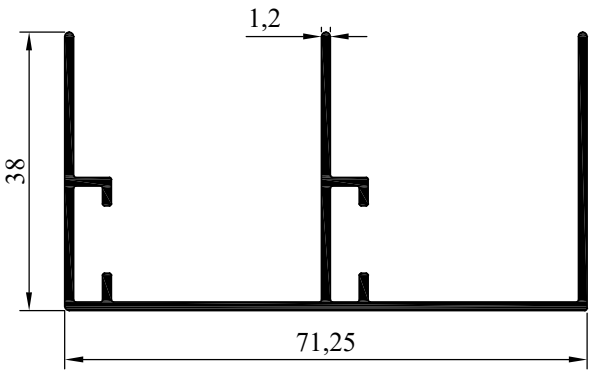

8387 - 664 gr/m

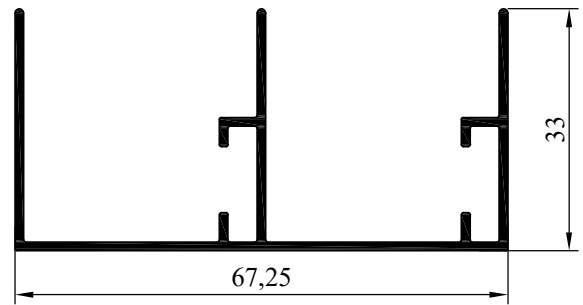

7687 - 604 gr/m

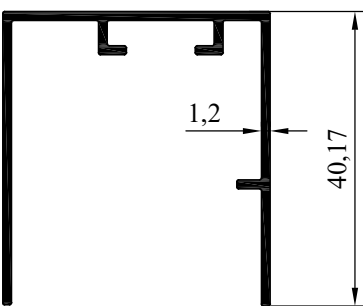

9283 - 428 gr/m

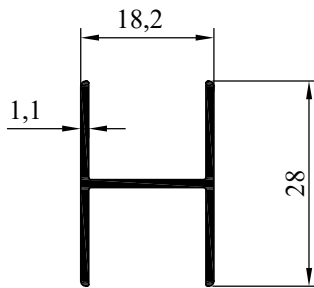

9777 - 213 gr/m

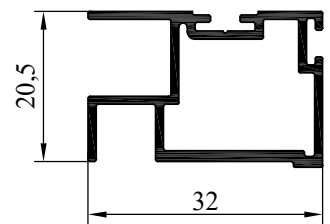

8202 - 397 gr/m

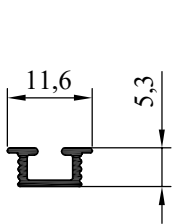

9782 - 61 gr/m

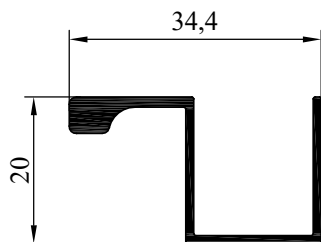

8672 - 286 gr/m

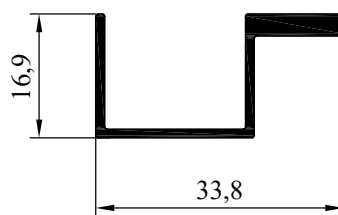

8196 - 270 gr/m

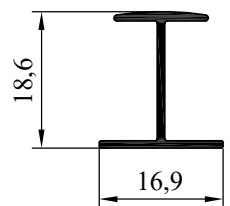

8673 - 131 gr/m

MOBİLYA PROFİLLERİ

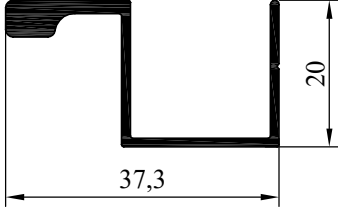

8198 - 328 gr/m

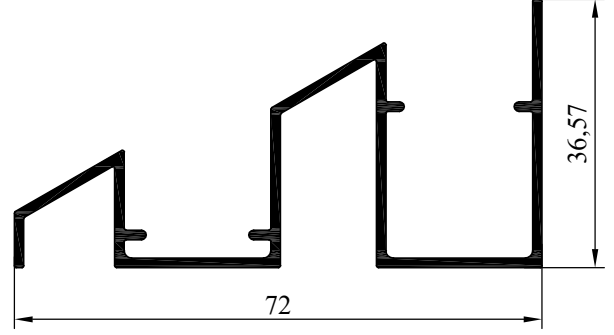

8199 - 679 gr/m

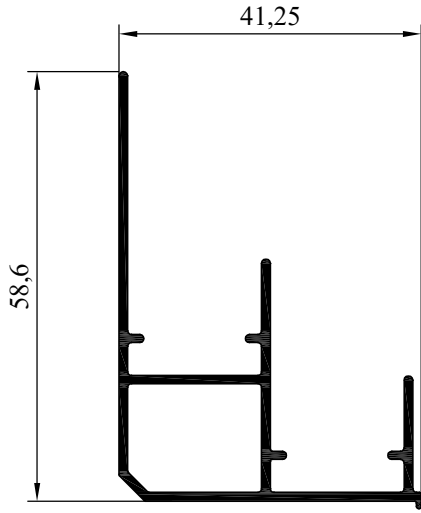

7688 - 551 gr/m

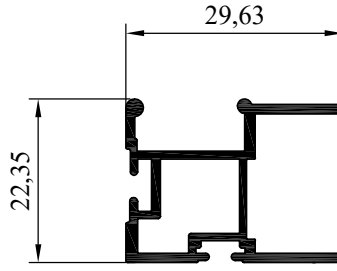

9099 - 370 gr/m

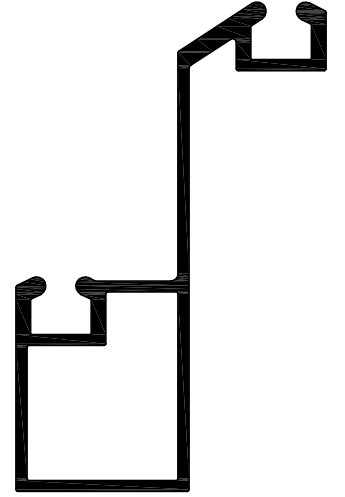

8299-807 gr



7700 - 755 gr/m

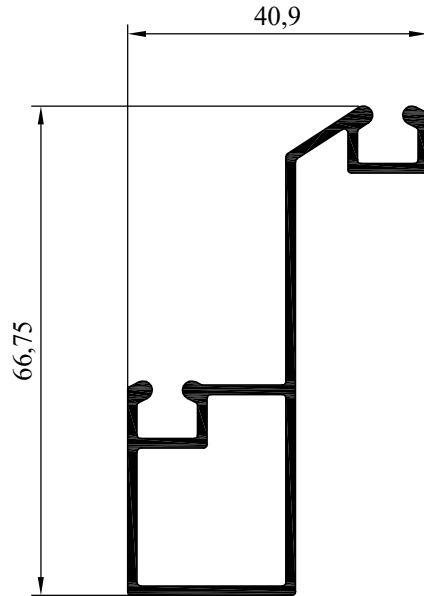

9545 - 654 gr/m

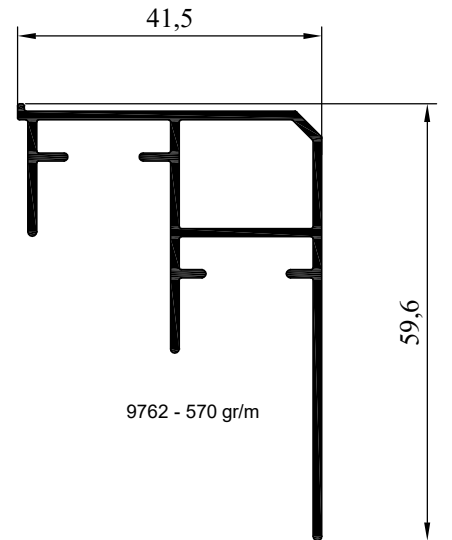

9762 - 570 gr/m

MOBİLYA PROFİLLERİ

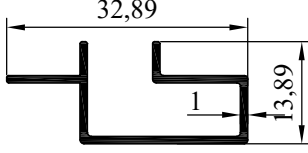

NO : 1656
AGIRLIK : 0.191 kg/m

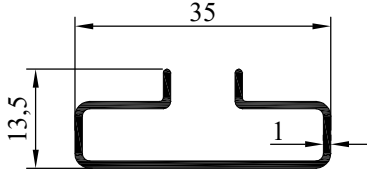

NO : 1659
AGIRLIK : 0.219 kg/m

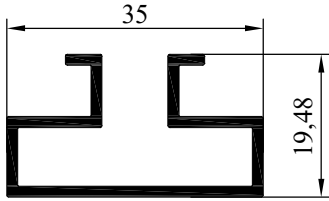

NO : 1725
AGIRLIK : 0.409 kg/m