









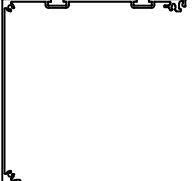
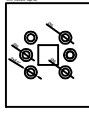

**- Z30 ZIP PERDE SİSTEMİ**  
**-Z30 ZIP CURTAIN SYSTEM**



**Z30**ZIP PERDE SİSTEMİ  
ZIP CURTAIN SYSTEM**ASISTAL**

## PROF L L STES - PROFILES LIST

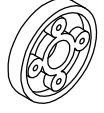
## AKSESUAR L STES - ACCESSORIES LIST

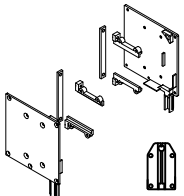
1203			EMZ30-06			
ÜST KUTU PROF L TOP BOX PROFILE	A IRLİK / Weight 2,176 kg/mt		LAMEL TUTUCU KAPAK TAKIMI COVER SET	A IRLİK / Weight Adet / Piece		
1204			EMZ30-03			
ÜST KUTU KAPAK PROF L TOP BOX COVER PROFILE	A IRLİK / Weight 0,681kg/mt		TÜP MOTOR 60RS 60NM+ALICI MOTOR	A IRLİK / Weight Adet / Piece		
1207			EMZ30-04-1			
ÜST KUTU KAPAK PROF L TOP BOX COVER PROFILE	A IRLİK / Weight 1,301 kg/mt		KUMANDA (Tek Kanallı) REMOTE CONTROL (Single Chanel)	A IRLİK / Weight Adet / Piece		
1205			EMZ30-04-2			
KANAL PROF L CHANEL PROFILE	A IRLİK / Weight 1079,3 kg/mt		KUMANDA (6 Kanallı) REMOTE CONTROL (6 Chanel)	A IRLİK / Weight Adet / Piece		
1206			EMZ30-05			
KANAL KAPAK PROF L CHANEL COVER PROFILE	A IRLİK / Weight 0,476 kg/mt		TAMBUR BA I MOTOR PROVISIONS	A IRLİK / Weight Adet / Piece		
1208			G100-A11-2			
ETEK PROF L BOTTOM PROFILE	A IRLİK / Weight 0,822 kg/mt		PLASTİK RULMAN YATA I ROLLER SLOT	A IRLİK / Weight Adet / Piece		
01-000100-15			G100-A11-4			
BORU PROF L Ø10 PIPE PROFILE	A IRLİK / Weight 0,110 kg/mt		RULMAN ROLLER	A IRLİK / Weight Adet / Piece		
Z30-A12			EMZ30-07			
GALVANİZ MOTOR BORU PROF L HORIZONTAL MOTOR PROFILE	A IRLİK / Weight 6 mt.		VİDA OTOMAT BA LANTI PVC CURTAIN WALL CONNECTIONS	A IRLİK / Weight 6MT.		
EMZ30-01						
ÜST KUTU MOTOR KAPAK TAKIM-ALT TKMI MOTOR SIDE COVER	A IRLİK / Weight Takım/Set					

\* Sipari öncesi kalıp bilgisi kontrol edilmeli / must be check profile production before the order

Profil a ırlıklarımız teorik olup; teslim anındaki tartımız geçerlidir.

# Z30

ZIP PERDE SİSTEMİ  
ZIP CURTAIN SYSTEM

## ASISTAL

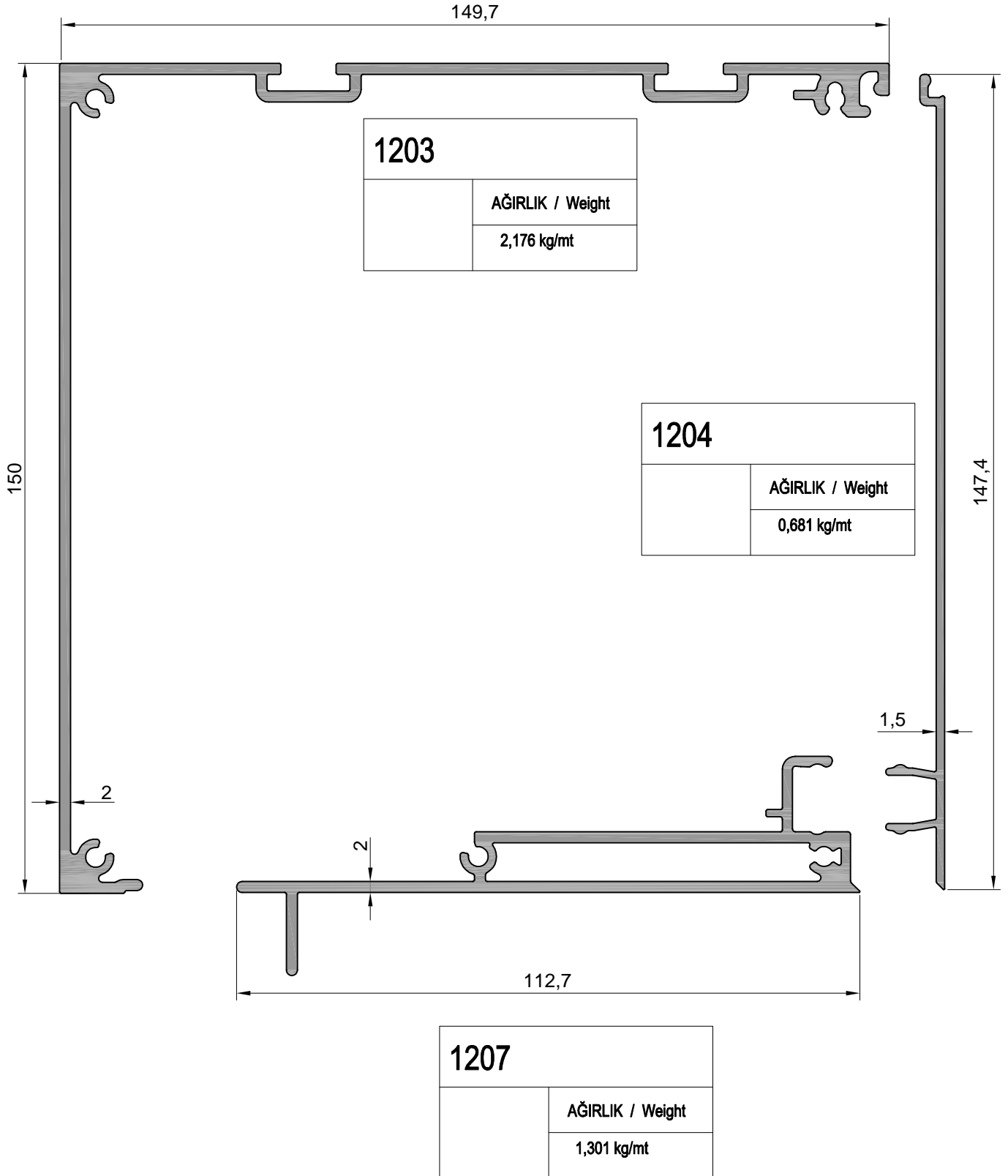

# Z30

ZIP PERDE SİSTEMİ  
ZIP CURTAIN SYSTEM

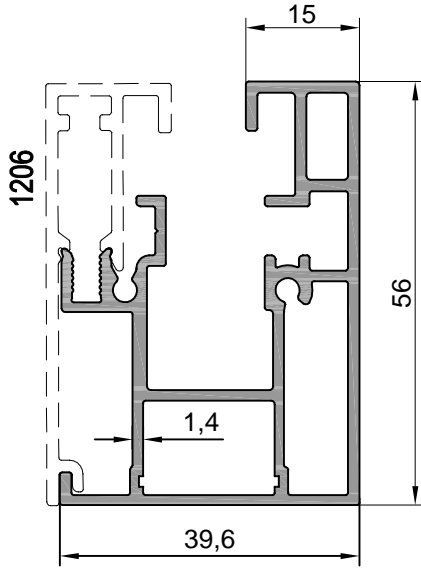

<b>1205</b>	
	AĞIRLIK / Weight
	1079,3 kg/mt

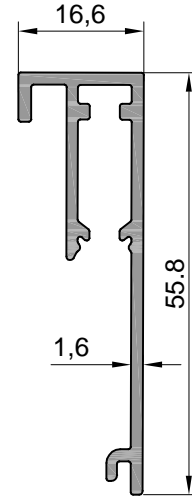

<b>1206</b>	
	AĞIRLIK / Weight
	0,476 kg/mt

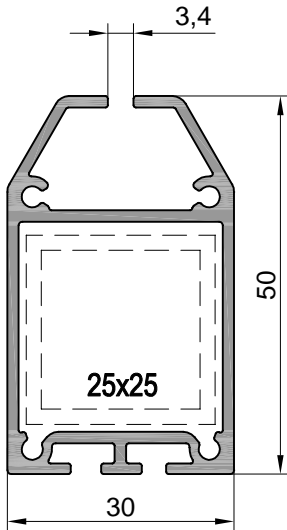

<b>1208</b>	
	AĞIRLIK / Weight
	0,822 kg/mt

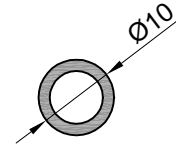

<b>01-000100-15</b>	
	AĞIRLIK / Weight
	0,110 kg/mt

**Z30**

ZIP PERDE SİSTEMİ  
ZIP CURTAIN SYSTEM



**SİSTEM DETAYLARI**  
*SYSTEM DETAILS*

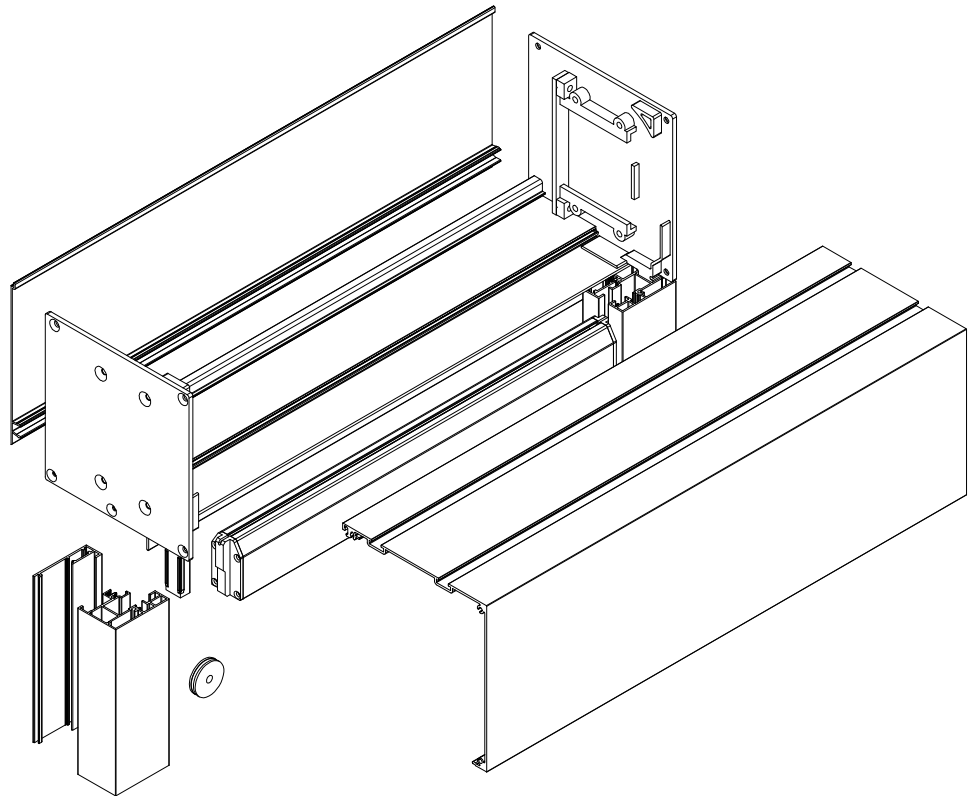
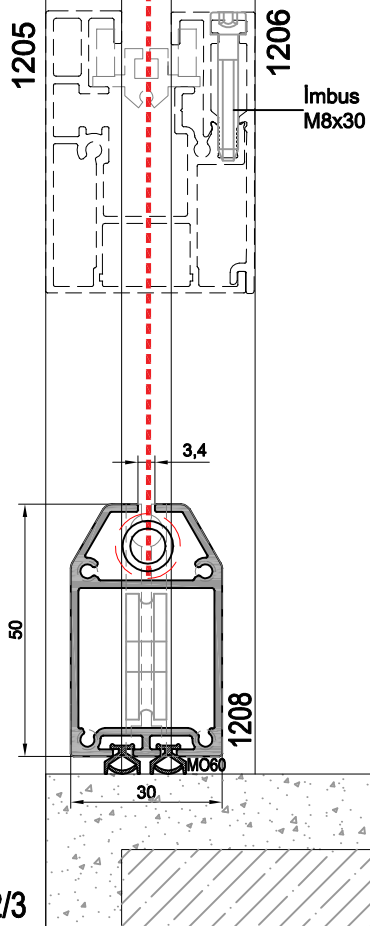
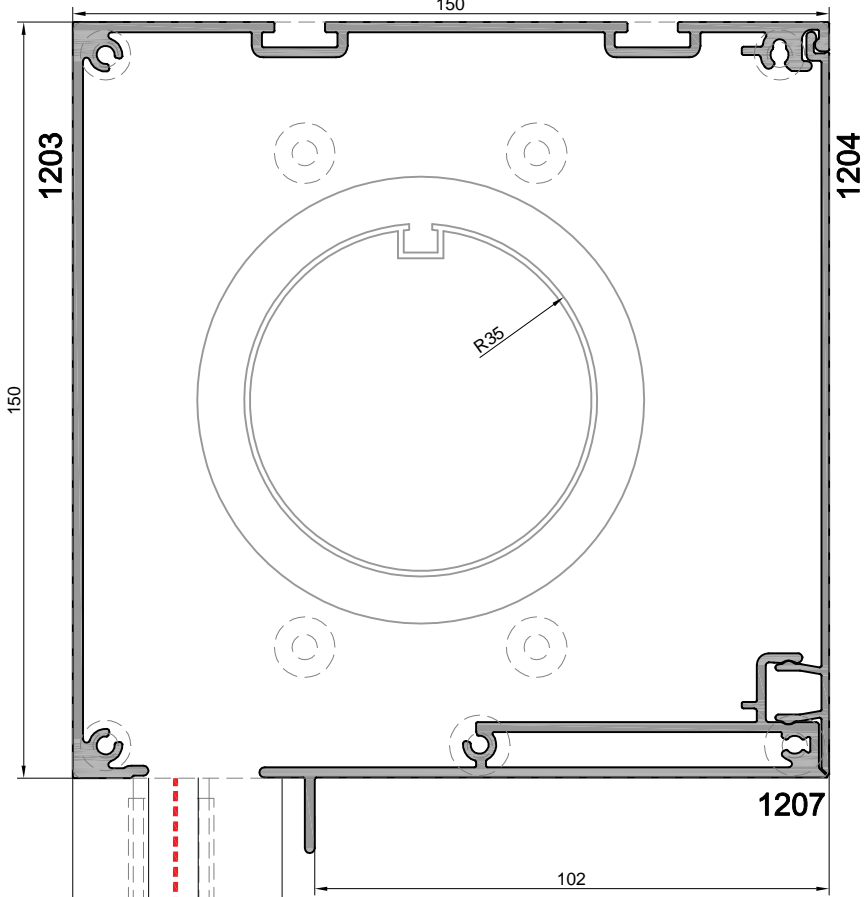

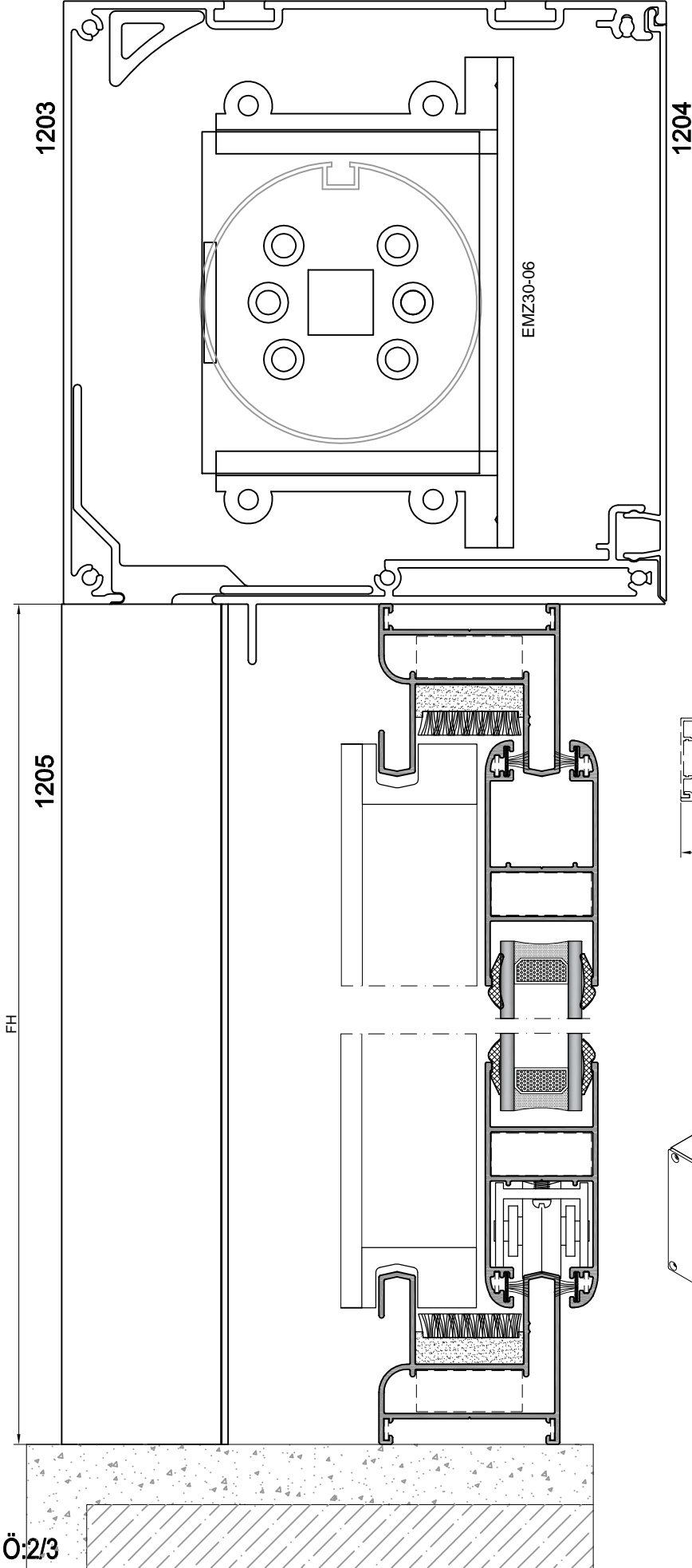

1 Takım için Z30 için Gerekli Aksesuar Listesi  
Required Accessories List for Z30 for 1 Set

AKASESUAR KODU Accessories Code	ADET Piece
Z30-A12	FW-110mm
EM30-01	1 TK_SET
EM30-06	1 TK_SET
EM30-03	1 TK_SET
EMZ30-04-1	1 ADT_Piece
EM30-03	1 ADT_Piece
G100-A11-2	1 ADT_Piece
G100-A11-4	1 ADT_Piece
EMZ30-07	FHx2

