

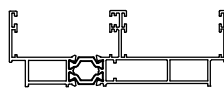

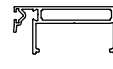

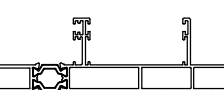

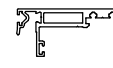

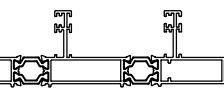

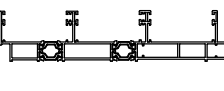

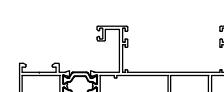
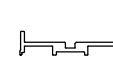
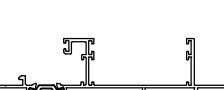



PROFİL ve AKSESUAR LİSTELERİ  
*PROFILE & ACCESSORIES LIST*



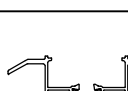

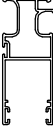

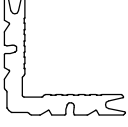











PROFİL LİSTESİ - PROFILE LISTS



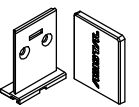



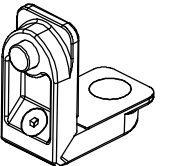

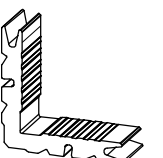
<b>ASM41T-01</b>	Jx cm <sup>4</sup>	Jy cm <sup>4</sup>		<b>ASM41T-41</b>	Jx cm <sup>4</sup>	Jy cm <sup>4</sup>	
	7,95	76,58			1,30	13,34	
İKİLİ KASA PROFİLİ <i>FRAME PROFILE</i>	AĞIRLIK / Weight			KANAT PROFİLİ <i>SASH PROFILE</i>	AĞIRLIK / Weight		
	1,697 Kg/mt				0,709 Kg/mt		
<b>ASM41T-01F</b>	Jx cm <sup>4</sup>	Jy cm <sup>4</sup>		<b>ASM41T-42</b>	Jx cm <sup>4</sup>	Jy cm <sup>4</sup>	
	9,88	165,61			0,87	8,60	
İKİLİ KASA PROFİLİ SİNEKLİKLİ RAYLI <i>FRAME PROFILE</i>	AĞIRLIK / Weight			KANAT PROFİLİ <i>SASH PROFILE</i>	AĞIRLIK / Weight		
	2,148 Kg/mt				0,736 Kg/mt		
<b>ASM41T-02</b>	Jx cm <sup>4</sup>	Jy cm <sup>4</sup>		<b>ASM41T-43</b>	Jx cm <sup>4</sup>	Jy cm <sup>4</sup>	
	12,07	254,41			11,48	157,32	
3'LÜ KASA PROFİLİ <i>FRAME PROFILE</i>	AĞIRLIK / Weight			KANAT PROFİLİ <i>SASH PROFILE</i>	AĞIRLIK / Weight		
	2,565 Kg/mt				1,361 Kg/mt		
<b>ASM41T-02F</b>	Jx cm <sup>4</sup>	Jy cm <sup>4</sup>		<b>ASM41T-44</b>	Jx cm <sup>4</sup>	Jy cm <sup>4</sup>	
	13,92	395,58			4,04	55,03	
3'LÜ KASA PROFİLİ SİNEKLİK RAYLI <i>FRAME PROFILE</i>	AĞIRLIK / Weight			KANAT PROFİLİ <i>SASH PROFILE</i>	AĞIRLIK / Weight		
	2,972 Kg/mt				1,526 Kg/mt		
<b>ASM41T-06</b>	Jx cm <sup>4</sup>	Jy cm <sup>4</sup>		<b>ASM41T-61</b>	Jx cm <sup>4</sup>	Jy cm <sup>4</sup>	
	7,20	8,53			0,10	4,77	
MONORAIL KASA PROFİLİ <i>FRAME PROFILE</i>	AĞIRLIK / Weight			RAY KANAL PROFİLİ <i>RAIL CHANNEL PROFILE</i>	AĞIRLIK / Weight		
	1,620 Kg/mt				0,492 Kg/mt		
<b>ASM41T-06F</b>	Jx cm <sup>4</sup>	Jy cm <sup>4</sup>		<b>ASM41T-62</b>	Jx cm <sup>4</sup>	Jy cm <sup>4</sup>	
	9,36	151,1			0,28	2,12	
SİNEKLİKLİ MONORAIL KASA PROFİLİ <i>FRAME PROFILE</i>	AĞIRLIK / Weight			İSPANYOLET KANAL PROFİLİ <i>CHANNEL PROFILE</i>	AĞIRLIK / Weight		
	2,107 Kg/mt				0,440 Kg/mt		
<b>ASM41T-12</b>	Jx cm <sup>4</sup>	Jy cm <sup>4</sup>		<b>ASM41T-64</b>	Jx cm <sup>4</sup>	Jy cm <sup>4</sup>	
	5,52	8,53			0,64	4,14	
ALT ÜST KANAT PROFİLİ <i>SASH PROFILE (Bottom-Top)</i>	AĞIRLIK / Weight			KAPAK PROFİLİ <i>COVER PROFILE</i>	AĞIRLIK / Weight		
	1,008 Kg/mt				0,302 Kg/mt		
<b>ASM41T-11</b>	Jx cm <sup>4</sup>	Jy cm <sup>4</sup>		<b>ASM41T-63</b>	AĞIRLIK / Weight		
	5,37	10,20			0,172 Kg/mt		
KİLİT KANAT PROFİLİ <i>SASH PROFILE</i>	AĞIRLIK / Weight			ORTA ADAPTOR PROFİL <i>ADAPTER PROFILE</i>	AĞIRLIK / Weight		
	1,009 Kg/mt				0,172 Kg/mt		
<b>ASM41T-13</b>	Jx cm <sup>4</sup>	Jy cm <sup>4</sup>		<b>ASM10-04</b>	Jx cm <sup>4</sup>	Jy cm <sup>4</sup>	
	6,27	15,26			0,64	4,14	
KİLİT KANAT PROFİLİ <i>SASH PROFILE</i>	AĞIRLIK / Weight			CAM ÇİTA PROFİLİ <i>GLAZING BEAD PRO.</i>	AĞIRLIK / Weight		
	1,129 Kg/mt				0,157 Kg/mt		
<b>ASM41T-14</b>	Jx cm <sup>4</sup>	Jy cm <sup>4</sup>		<b>ASM41T-38</b>	Jx cm <sup>4</sup>	Jy cm <sup>4</sup>	
	8,52	19,55			0,59	1,99	
KİLİT KANAT PROFİLİ <i>SASH PROFILE</i>	AĞIRLIK / Weight			MONORAIL CAM ÇİTA PRO. <i>GLAZING BEAD PRO.</i>	AĞIRLIK / Weight		
	1,175 Kg/mt				0,346 Kg/mt		

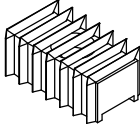
## PROFİL LİSTESİ - PROFILE LISTS

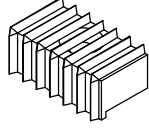
13-09986	Jx cm <sup>4</sup>	Jy cm <sup>4</sup>			
	11,42	2,78			
SİNEKLİK KANAT PROFİLİ <i>FLYSCREEN SASH PROFILE</i>	AĞIRLIK / Weight				
	0,741 kg/mt				
SL34T-52					
SİNEKLİK KANAT PROFİLİ <i>FLYSCREEN SASH PROFILE</i>	AĞIRLIK / Weight				
	0,468 kg/mt				
1725	Jx cm <sup>4</sup>	Jy cm <sup>4</sup>			
	1,43	2,75			
SİNEKLİK KASA PROFİLİ <i>FLYSCREEN FRAME PROFILE</i>	AĞIRLIK / Weight				
	0,507 kg/mt				
10-010106-00					
KÖŞE TAKOZU 10,6 mm <i>CORNER JOINT</i>	AĞIRLIK / Weight				
	2,653 kg/mt				

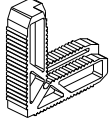
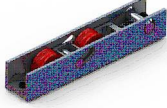
## AKSESUAR LİSTESİ - ACCESSORIES LIST

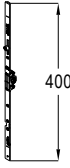
KF 67-550			EP 03 010612		
FIRÇA FİTİL - 5,5 mm BRUSH GASKET	KOLİ MİKTARI/Package 375 mt		ADAPTOR KANAL FİTİLİ ADAPTER GASKET	KOLİ MİKTARI/Package 1000 mt / 15 kg	
KF 67-700			EP38-02		
FIRÇA FİTİL - 7 mm BRUSH GASKET	KOLİ MİKTARI/Package 300 mt		KASA KANAL FİTİLİ FRAME GASKET	KOLİ MİKTARI/Package 300 mt / 15 kg	
KF 67-1000			ASI-5025		
FIRÇA FİTİL - 10 mm BRUSH GASKET	KOLİ MİKTARI/Package 200 mt		SİNEKLİK FİTİLİ FLYSCREEN GASKET	KOLİ MİKTARI/Package 100 mt	
KF 67-1500			EM41T-62 PVC		 SC:1/2
FIRÇA FİTİL - 15 mm BRUSH GASKET	KOLİ MİKTARI/Package 125 mt		PVC KANAL PROFİLİ BOTTOM CHANNEL PROFILE	KOLİ MİKTARI/Package 6 mt / Adet	
EP3-03			EM41T-61 PVC		 SC:1/2
KANAT BİNİ FİTİLİ SASH GASKET	KOLİ MİKTARI/Package 430 mt / 15 kg		PVC KANAL PROFİLİ BOTTOM CHANNEL PROFILE	KOLİ MİKTARI/Package 6 mt / Adet	
EP2-01			12-41P		
İÇ CAM FİTİLİ - 3 mm INNER GLAZING GASKET	KOLİ MİKTARI/Package 440 mt / 15 kg		POLYAMİD TİJ PROFİLİ POLYAMİDE CONNECTING ROD PROFILE - 19mm	KOLİ MİKTARI/Package 6mt / Adet	
EP2-02			AS41T-KP		
İÇ CAM FİTİLİ - 4 mm INNER GLAZING GASKET	KOLİ MİKTARI/Package 300 mt / 15 kg		KENET KAPAĞI-ALT/ÜST INTERLOCK PROFILE CAP TOP / BOTTOM	KOLİ MİKTARI/Package Adet / Piece	
EP2-03			ASI-SB 19.1		
İÇ CAM FİTİLİ - 5 mm INNER GLAZING GASKET	KOLİ MİKTARI/Package		KÖŞE GÖNYESİ CORNER ALIGNMENT	KOLİ MİKTARI/Package 1000 Adet / Piece	
ASM41T-EP04			ASI-PB 1119		
KENET FİTİLİ INTERLOCK GASKET	KOLİ MİKTARI/Package 145 mt / 15 kg		PİMLİ KÖŞE BAĞLANTI CORNER JOINT	KOLİ MİKTARI/Package Adet / Piece	
ASM41T-PLZ04			ASI-KT 1119		
KENET FİTİLİ INTERLOCK GASKET	KOLİ MİKTARI/Package 6 mt / Adet		KÖŞE TAKOZU CORNER JOINT	KOLİ MİKTARI/Package Adet / Piece	

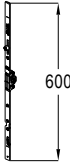
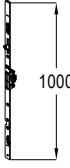
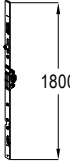
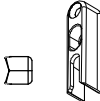
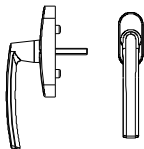
<b>ASI-41T-SFP 01</b>			<b>ASI-WH 006</b>		
ALT ÜST HAVA KESİCİ BOTTOM-TOP WEATHER PROTECTOR	KOLİ MİKTARI/Package Adet / Piece		GÖMME İSPANYOLET KİLİTLEME KOL EMBEDDED HANDLE FOR MULTI POINT LOCK	KOLİ MİKTARI/Package Adet / Piece	
<b>ASI-41T-SFP 02</b>			<b>1028</b>		
ALT ÜST HAVA KESİCİ ASM41T-06 KASA BOTTOM-TOP WEATHER PROTECTOR	KOLİ MİKTARI/Package Adet / Piece		SİNEKLİK KASA KÖŞE BAĞLANTI FLY SCREEN FRAME CORNER JOINT	KOLİ MİKTARI/Package 6mt / Adet	
<b>ASI-SR 02R-INOX</b>			<b>ASI-BZ 5007</b>		
PASLANMAZ RULMAN (U TİPİ RAY İÇİN) DOUBLE SLIDING ROLLER FOR RAIL TYPE - U	KOLİ MİKTARI/Package Adet / Piece		SİNEKLİK PROFİLİ KÖŞE BAĞLANTI CORNER JOINT FOR FLYSCREEN SASH	KOLİ MİKTARI/Package	
<b>ASI-SR 02R</b>			<b>ASI-INR 01</b>		
AYARLI ÇİFTLİ RULMAN (U TİPİ RAY İÇİN) DOUBLE SLIDING ROLLER FOR RAIL TYPE - U	KOLİ MİKTARI/Package Adet / Piece		ÇELİK RAY STEEL RAIL	KOLİ MİKTARI/Package 6 mt / Adet	
<b>ASI-ISP15.0</b>			<b>EM41T-65</b>		
İSPANYOLET KİLİTLEME (400mm) MULTI POINT LOCK	KOLİ MİKTARI/Package Adet / Piece		SİNEKLİK YÜKSELTME ADAPTORÜ-PVC FLY SCREEN ADAPTER	KOLİ MİKTARI/Package 6 mt / Adet	
<b>ASI-ISP15.1</b>					
İSPANYOLET KİLİTLEME (600mm) MULTI POINT LOCK	KOLİ MİKTARI/Package Adet / Piece				
<b>ASI-ISP15.2</b>					
İSPANYOLET KİLİTLEME (1000mm) MULTI POINT LOCK	KOLİ MİKTARI/Package Adet / Piece				
<b>ASI-ISP15.3</b>					
İSPANYOLET KİLİTLEME (1800mm) MULTI POINT LOCK	KOLİ MİKTARI/Package Adet / Piece				
<b>ASI-ISP K02</b>					
İSPANYOLET KİLİT KARŞILIK MULTI POINT LOCK STRIKER	KOLİ MİKTARI/Package Adet / Piece				
<b>ASI-WH 002</b>					
İSPANYOLET KİLİTLEME KOL MULTI POINT LOCK HANDLE	KOLİ MİKTARI/Package Adet / Piece				

**AS41T**

MINİMAL SÜRME SİSTEMİ  
MINIMAL SLIDING SYSTEM

**ASISTAL**

**PROFİL DETAYLARI**  
*PROFILE DETAILS*

# AS41T

MİNİMAL SÜRME SİSTEMİ  
MINIMAL SLIDING SYSTEM

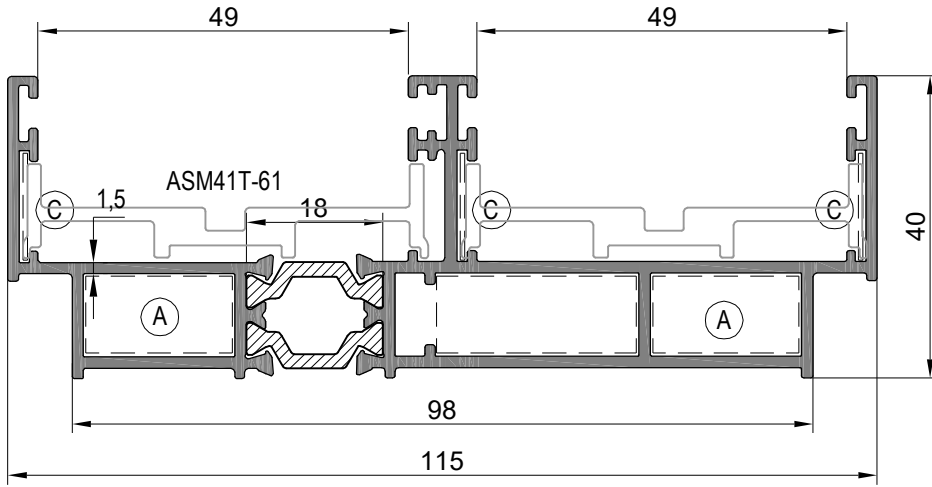

## ASM41T-01

		AĞIRLIK / Weight
ASI-PB 1119 - ASI-KT 1119 ASI-SB 19.1		1,697 kg/mt

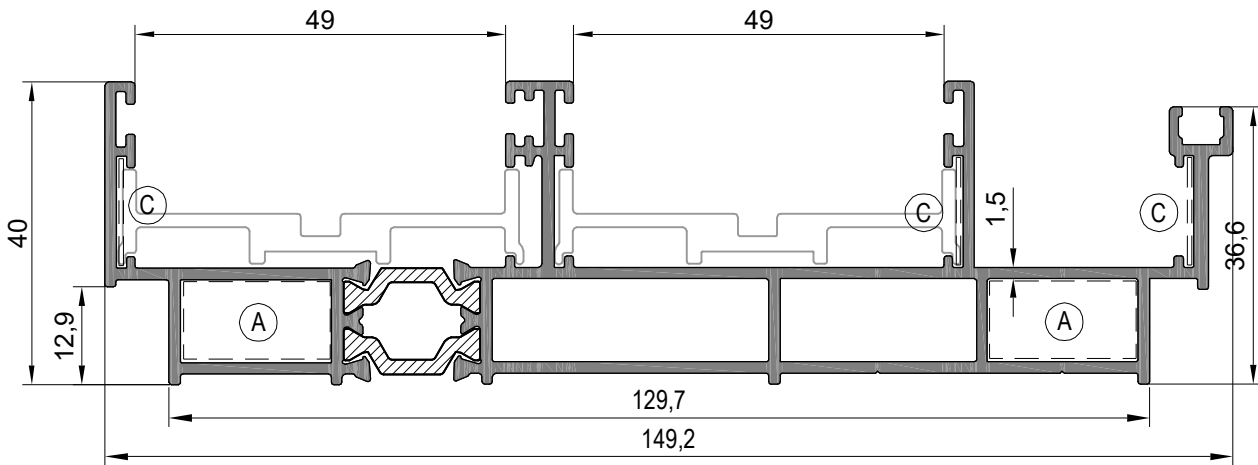

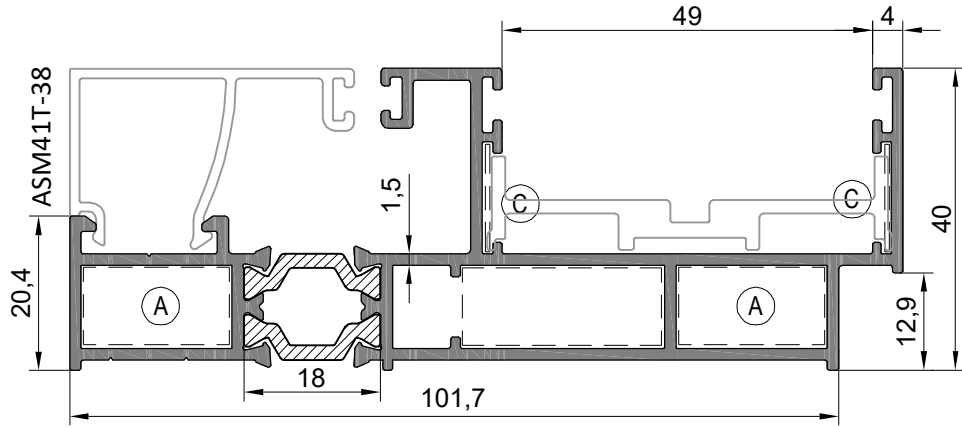

## ASM41T-01F

		AĞIRLIK / Weight
ASI-PB 1119 - ASI-KT 1119 ASI-SB 19.1		2,102 kg/mt





## ASM41T-06

		AĞIRLIK / Weight
ASI-PB 1119 ~ ASI-KT 1119	ASI-SB 19.1	1,620 kg/mt

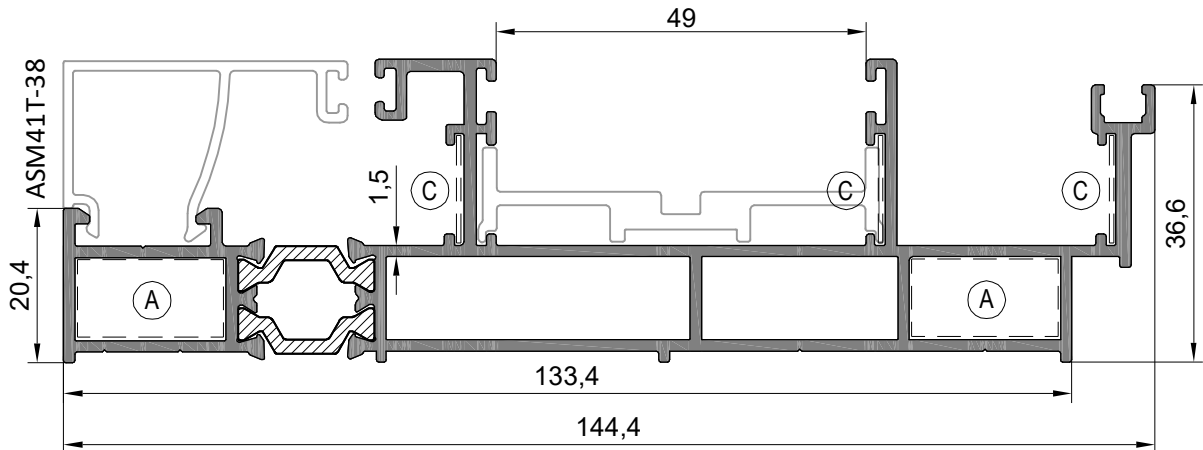
Profil ağırlıklarımız teorik olup; teslim anındaki tartımız geçerlidir.



## ASM41T-06F

		AĞIRLIK / Weight
ASI-PB 1119 ~ ASI-KT 1119	ASI-SB 19.1	2,107 kg/mt

Profil ağırlıklarımız teorik olup; teslim anındaki tartımız geçerlidir.



# AS41T

MİNİMAL SÜRME SİSTEMİ  
MINIMAL SLIDING SYSTEM

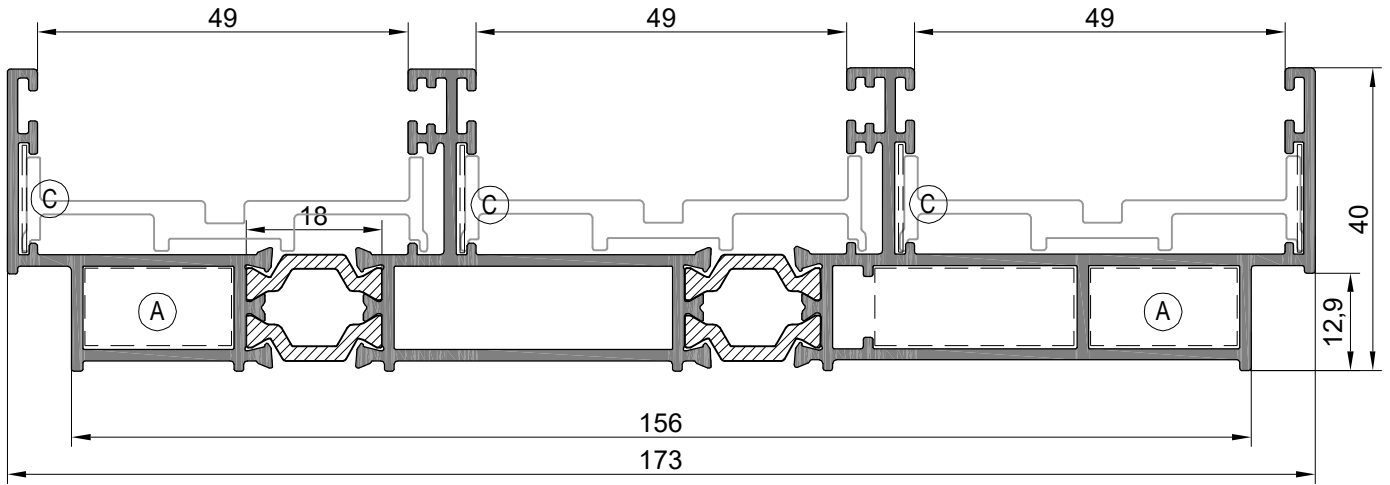

ASM41T-02

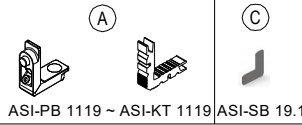

AĞIRLIK / Weight

2,565 kg/mt

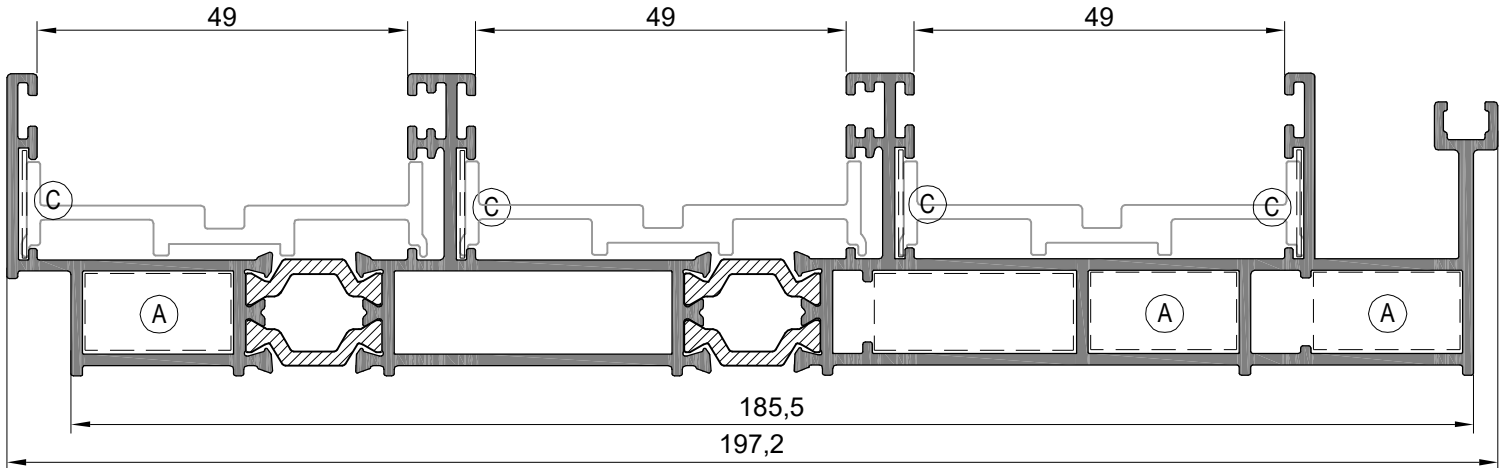

ASM41T-02F

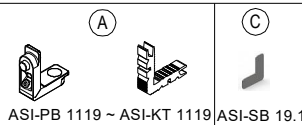

AĞIRLIK / Weight

2,972 kg/mt

# AS41T

MİNİMAL SÜRME SİSTEMİ  
MINIMAL SLIDING SYSTEM

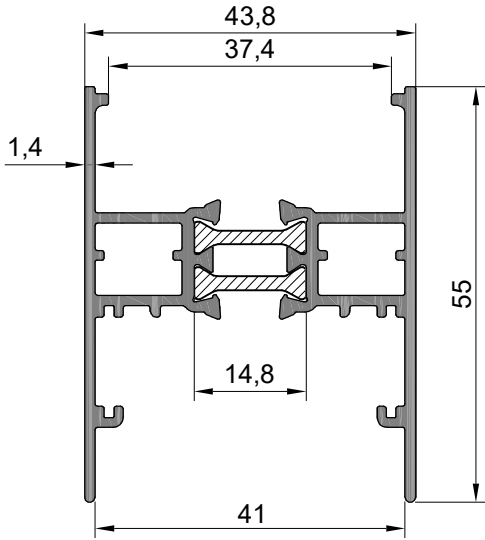

**ASM41T-11**  
1,009kg/mt

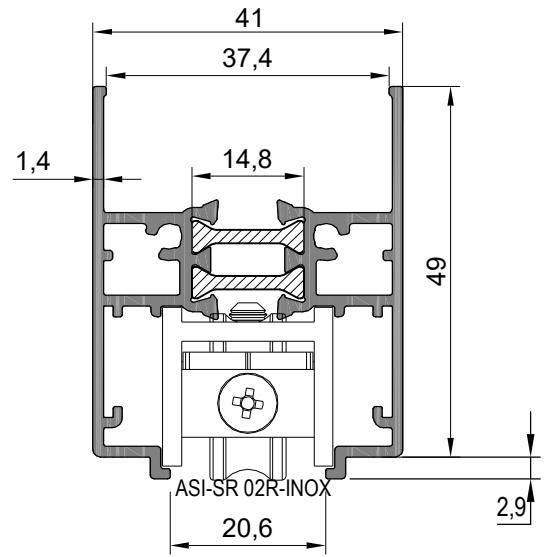

**ASM41T-12**  
1,008 kg/mt

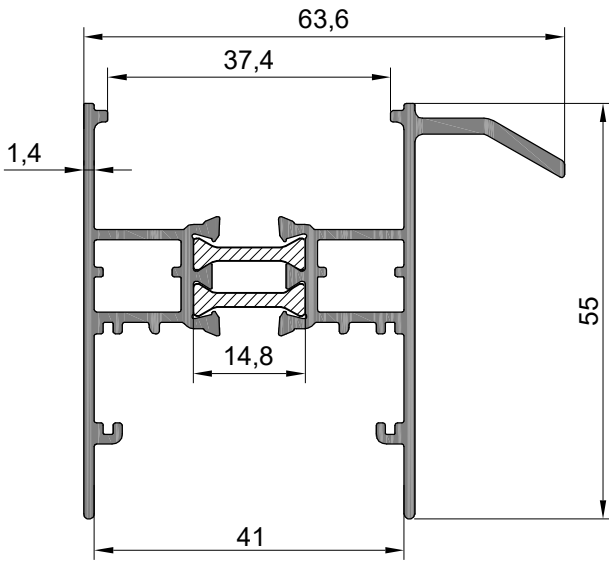

**ASM41T-13**  
1,129 kg/mt

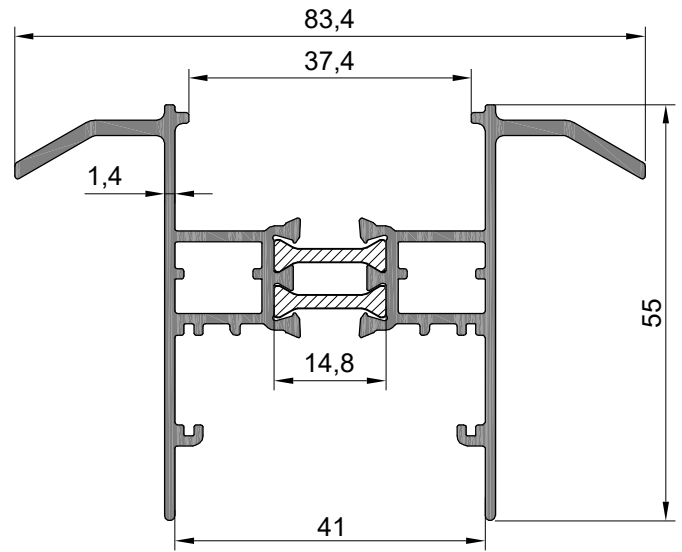

**ASM41T-14**  
1,175 kg/mt

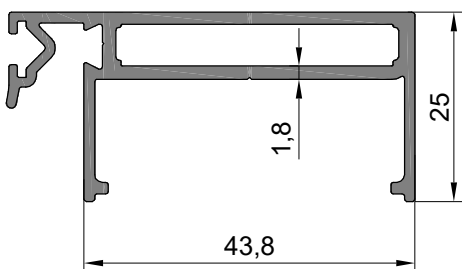

**ASM41T-41**  
0,707 kg/mt

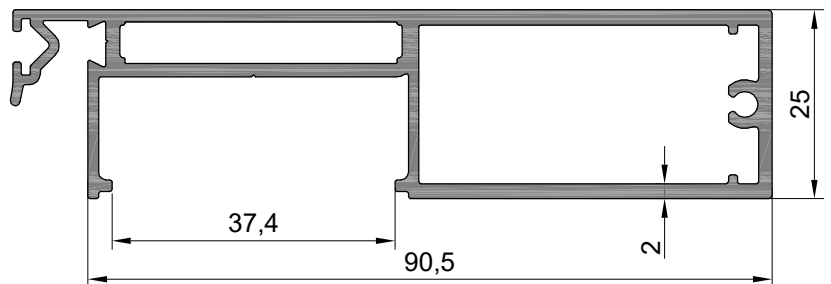

**ASM41T-43**  
1,359 kg/mt

# AS41T

MINİMAL SÜRME SİSTEMİ  
MINIMAL SLIDING SYSTEM

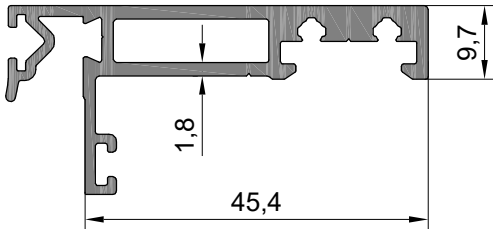

**ASM41T-42**  
0,734 kg/mt

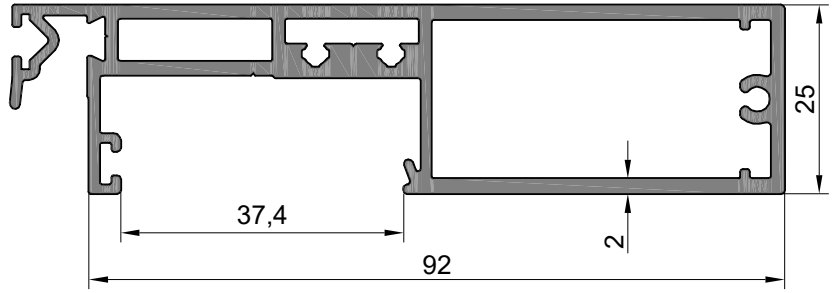

**ASM41T-44**  
1,524 kg/mt

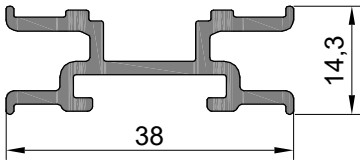

**ASM41T-62**  
0,440 kg/mt

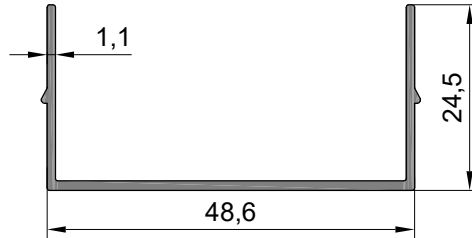

**ASM41T-64**  
0,302 kg/mt

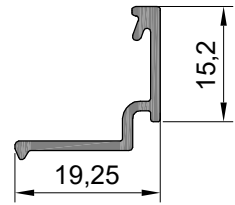

**ASM10-04**  
0,157 kg/mt

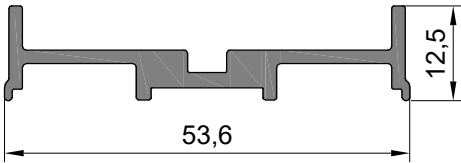

**ASM41T-61**

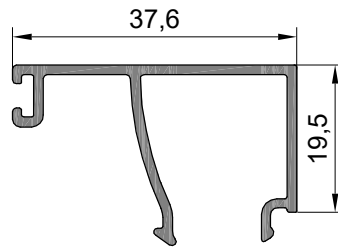

**ASM41T-38**  
0,346 kg/mt

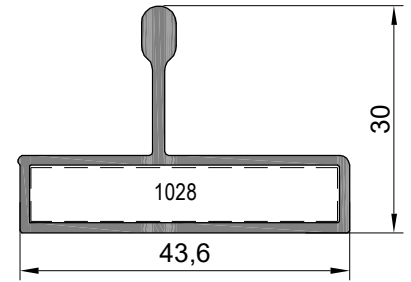

**1725**  
0,507 kg/mt

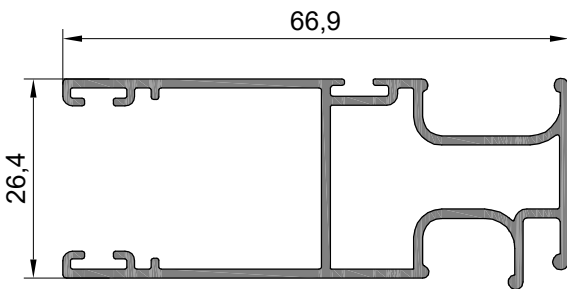

**13-09986**  
0,741 kg/mt

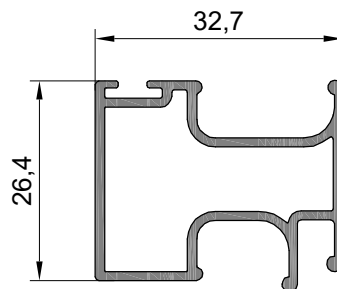

**18677**  
0,468 kg/mt

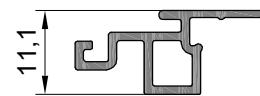

**ASM41T-63**  
0,172 kg/mt

# AS41T

MİNİMAL SÜRME SİSTEMİ  
MINIMAL SLIDING SYSTEM

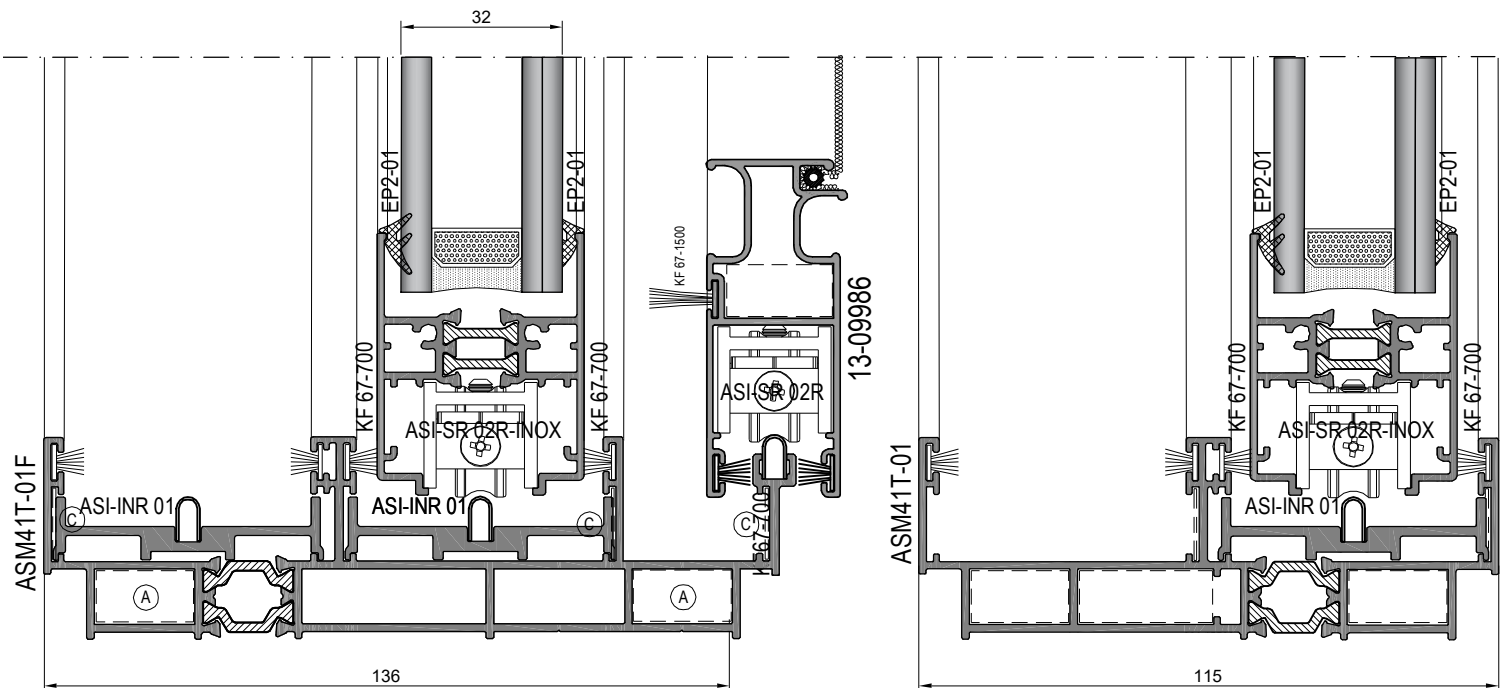
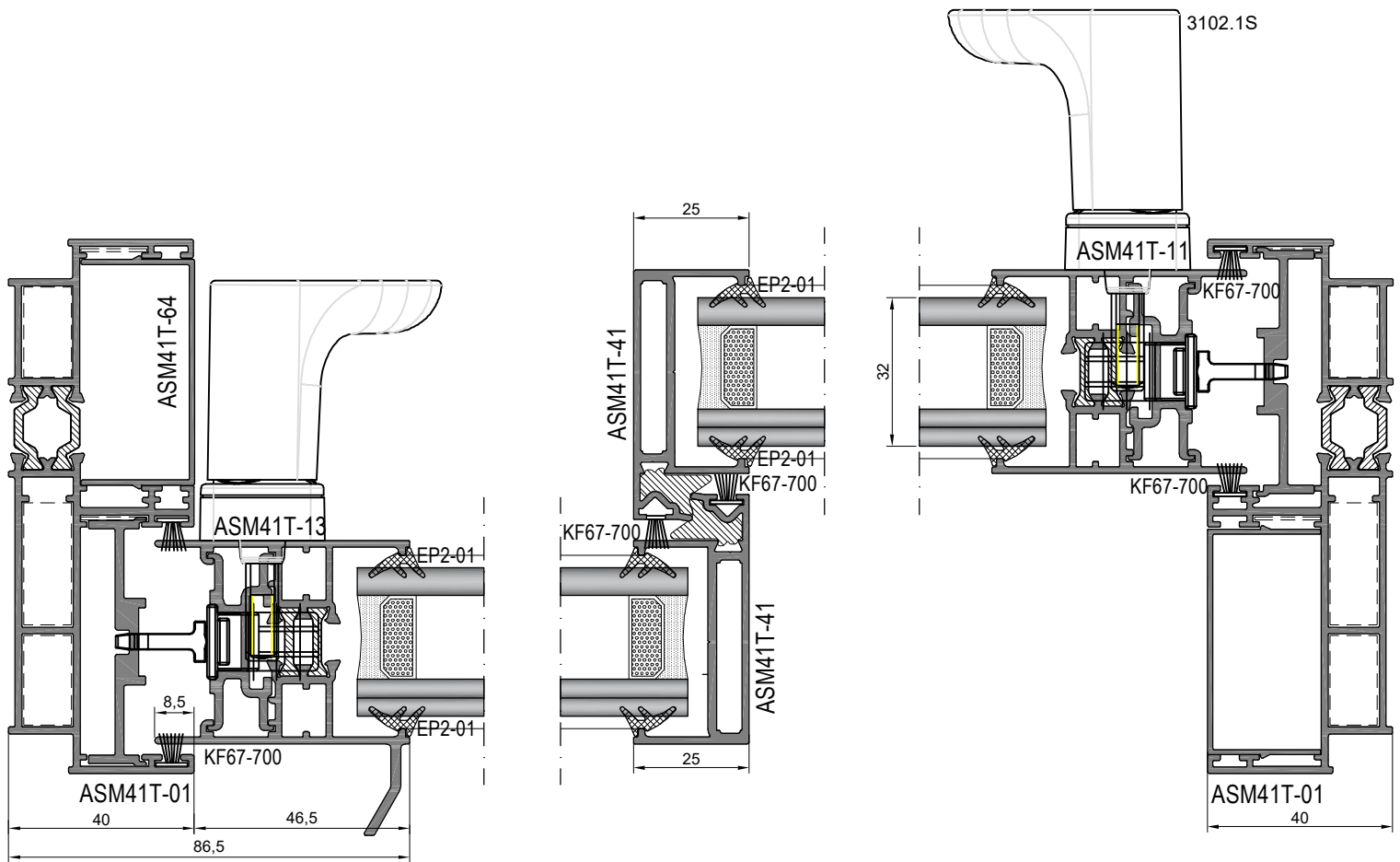

# AS41T

MİNİMAL SÜRME SİSTEMİ  
MINIMAL SLIDING SYSTEM

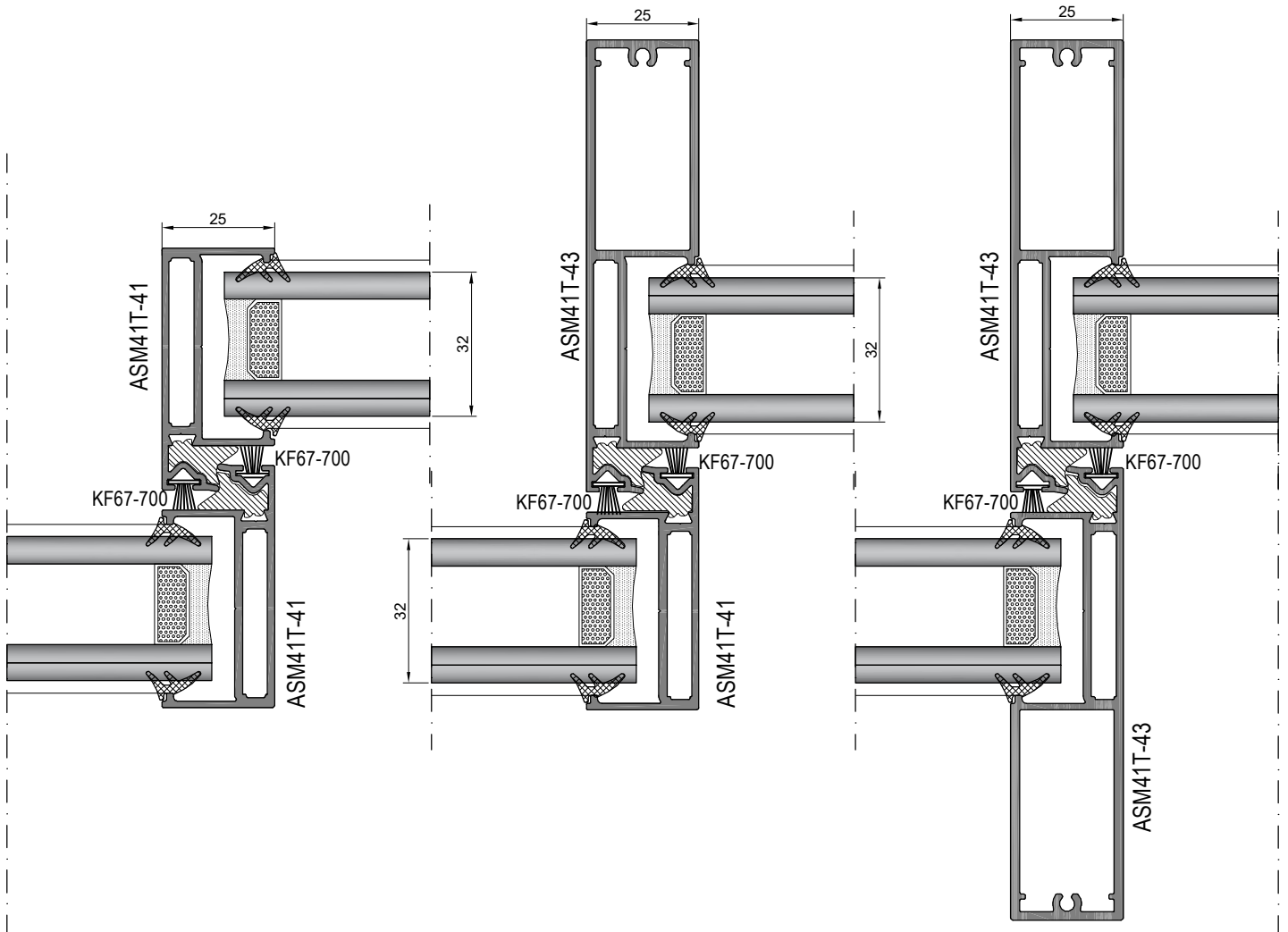
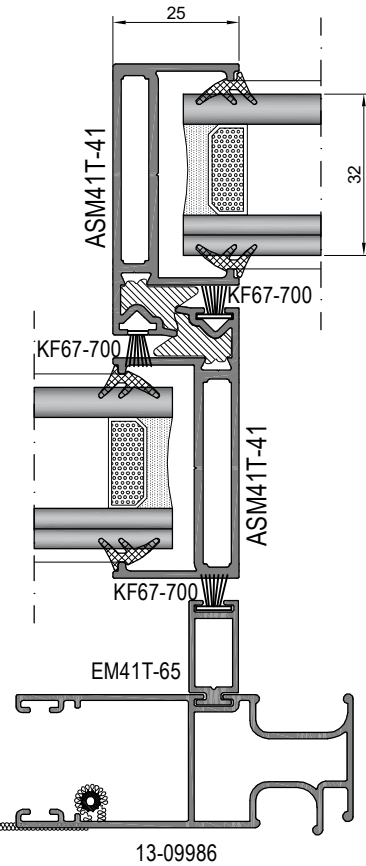
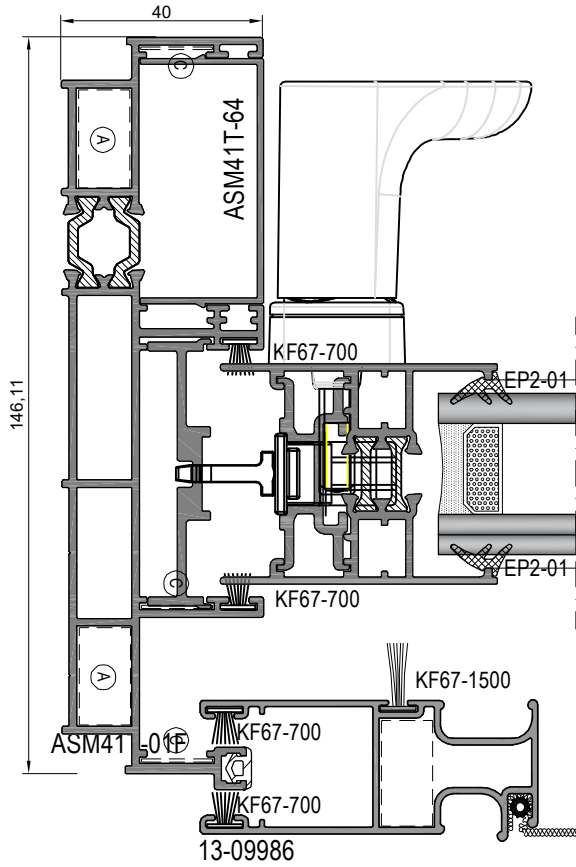

# AS41T

MİNİMAL SÜRME SİSTEMİ  
MINIMAL SLIDING SYSTEM

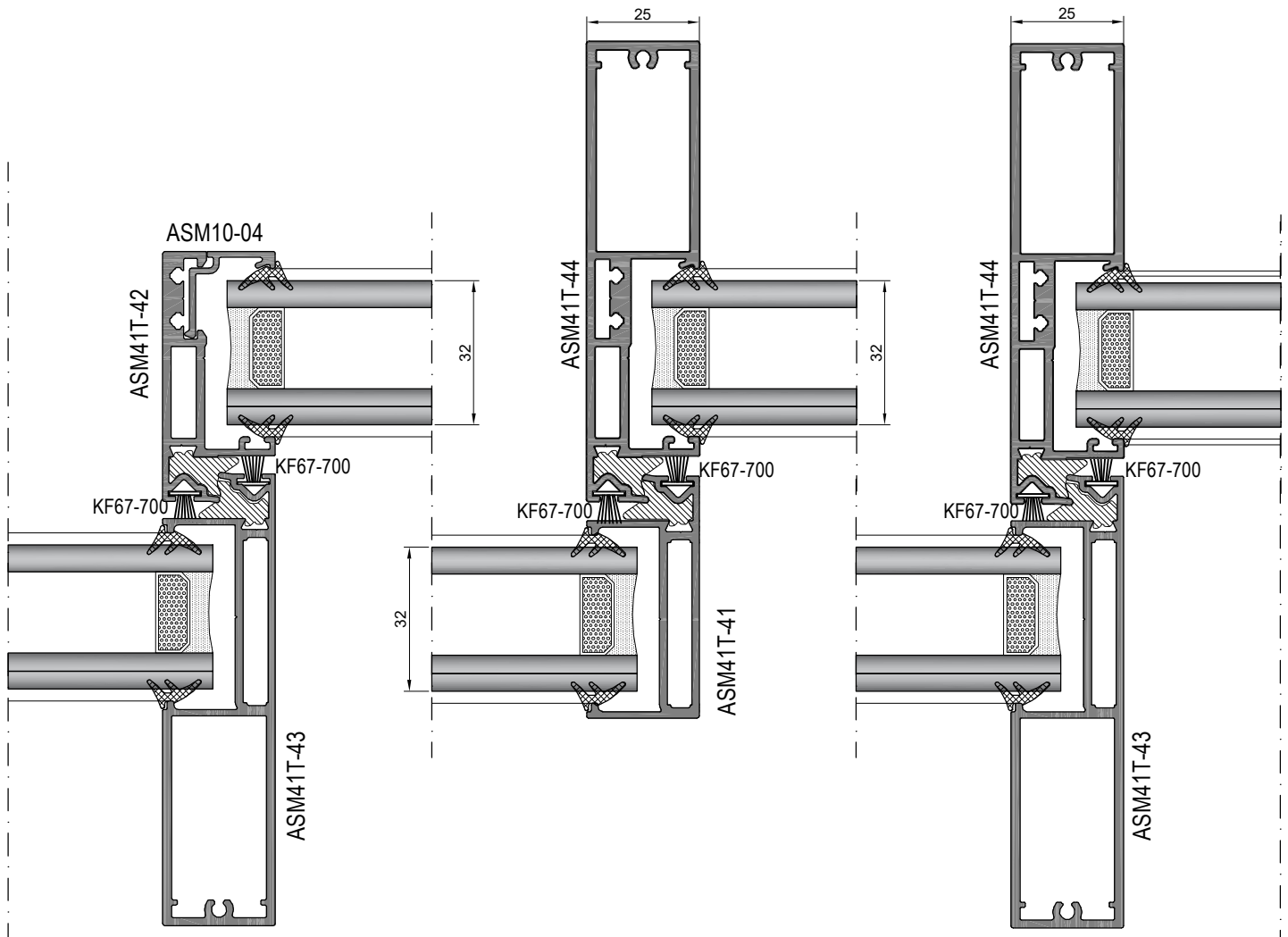
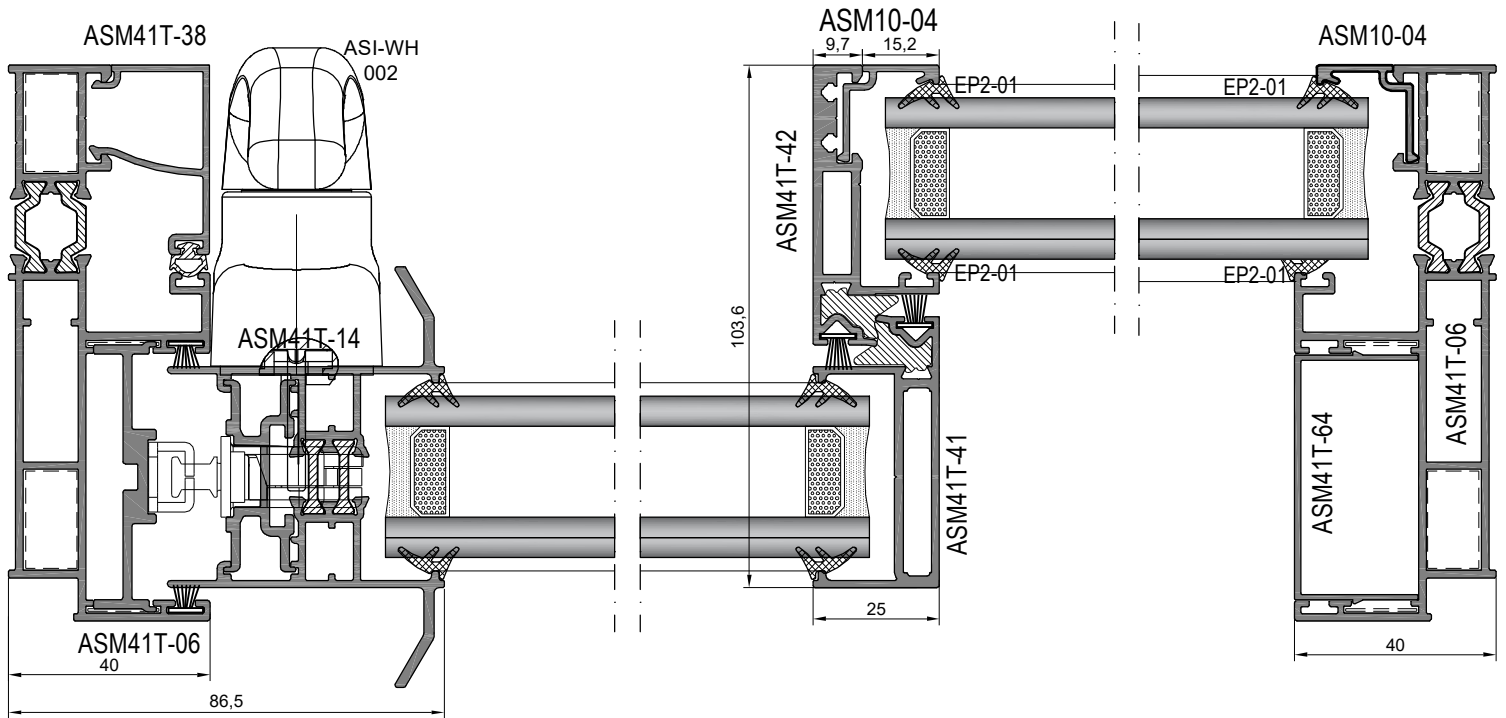

# AS41T

MİNİMAL SÜRME SİSTEMİ  
MINIMAL SLIDING SYSTEM

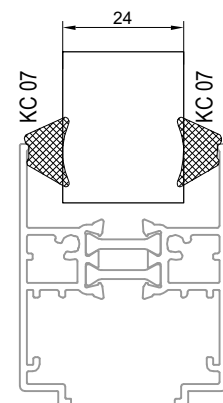
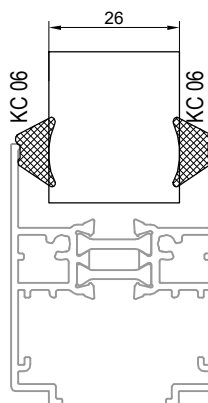
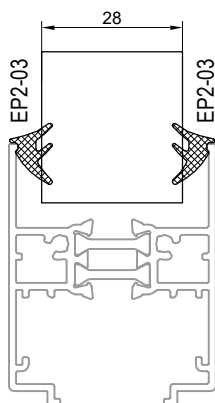
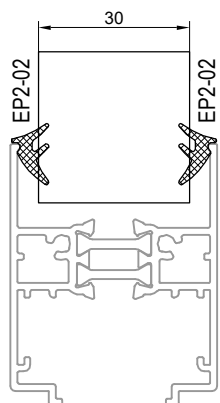
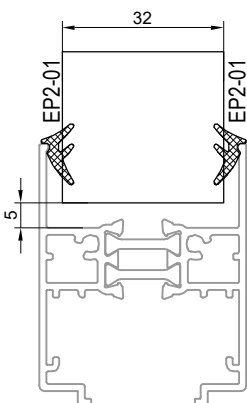
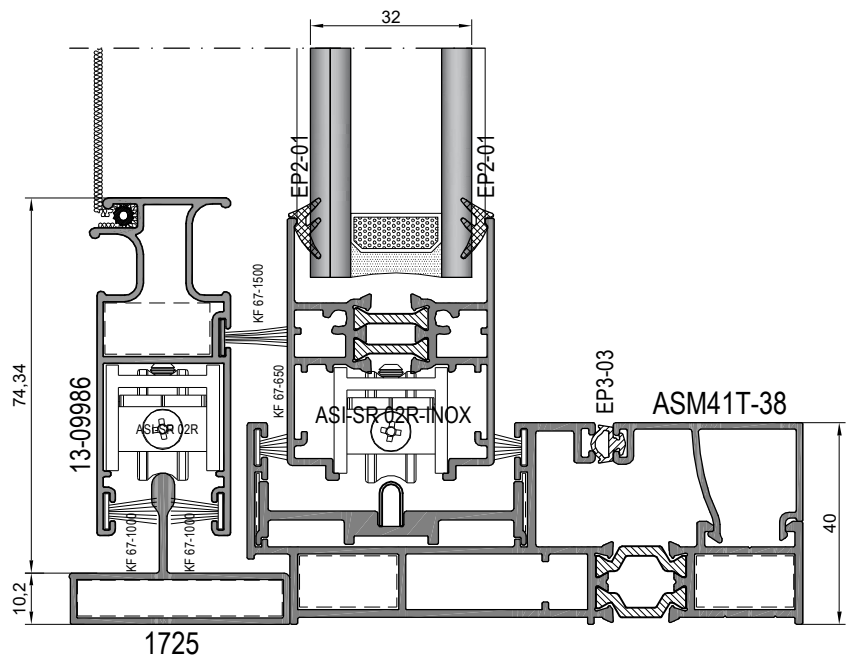
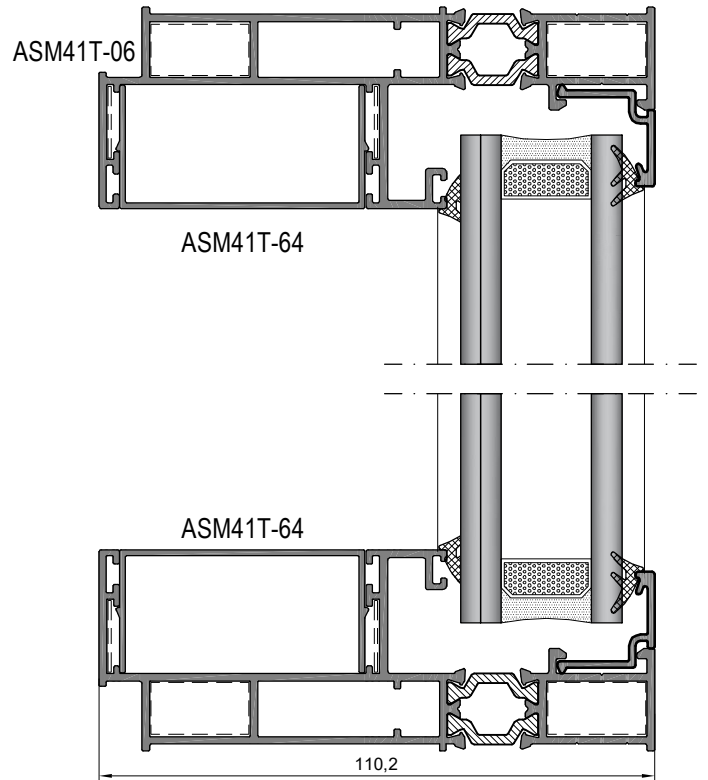
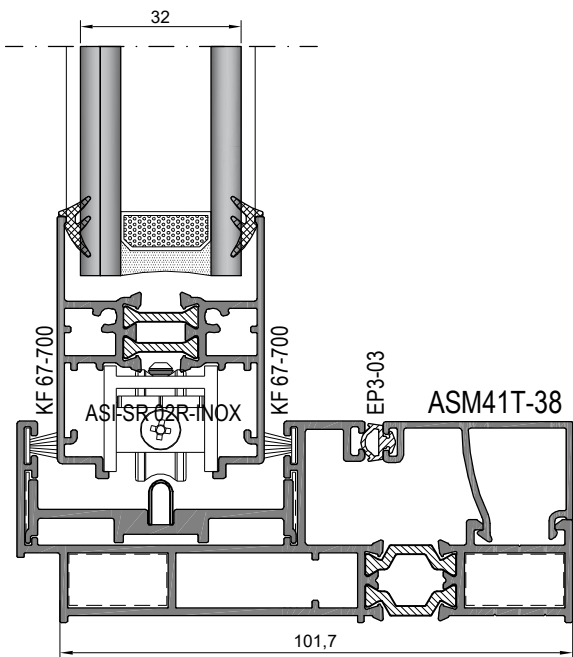
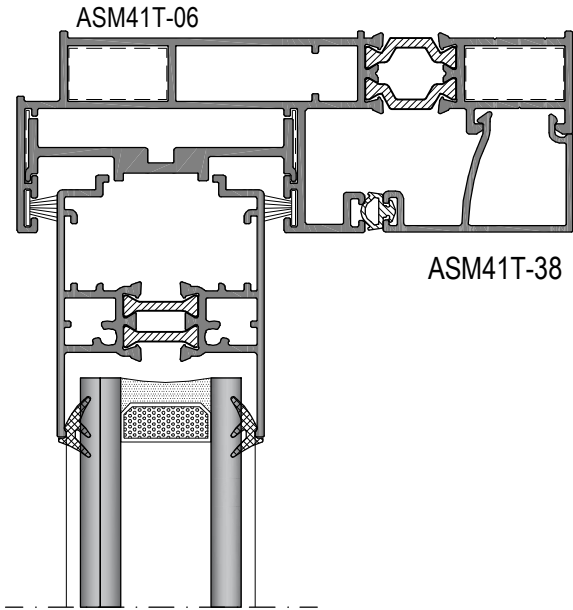

# AS41T

MİNİMAL SÜRME SİSTEMİ  
MINIMAL SLIDING SYSTEM

