

• STANDART PROFİLLER

Profil No Profile No			B. Ağırlık Weight (kg/m)	Profil No Profile No			B. Ağırlık Weight (kg/m)
	a (mm)	b (mm)			a (mm)	b (mm)	
448	12,5	4,6	0,160	460	60	6	0,980
428	13	3	0,110	444	60	10	1,630
472	13,8	8,9	0,340	480	60	30	4,885
423	15	3	0,125	403	70	10	1,900
449	17	2	0,100	8584	72	22	4,300
450	18	2	0,100	465	80	6	1,310
417	18	4	0,200	458	80	8	1,740
416	18	7	0,345	479	80	10	2,175
4849	19,8	6	0,325	402	90	4	0,980
422	20	3	0,170	461	90	10	2,450
9600	25	2	0,140	401	92	3,5	0,880
418	20	5	0,275	411	100	5	1,360
406	25	5	0,345	425	100	10	2,710
491 *	25	5,65	0,390	481	100	20	5,430
447	30	3	0,245	456	100	40	10,850
464	30	4	0,330	462	101	7	1,920
405	30	5	0,410	473	101	15	4,110
414	30	8	0,655	410	103,5	4	1,130
487	35	3	0,290	409	112,5	3	0,915
4848 ***	35	17	1,615	474	139	10	3,775
446	36	3	0,295	477	150	20	8,140
489	38	7	0,730	454	155	15	6,300
459	40	2	0,220	475	165	6	2,690
468	40	3	0,340	484	177	3	1,450
439	40	5	0,545	476	200	10	5,430
478	40	6	0,660	500	200	15	8,140
404	40	10	1,090	466	200	20	10,850
470	43,5	9,7	1,150	8444	200	25	13,555
8585	45	8	0,980				
467 **	46,8	27,8	3,510				
11584	50	2	0,275				
427	50	5	0,680				
445	50	6	0,815				
442	50	10	1,360				
457	59	12	1,925				
412	60	5	0,815				

* Köşeleri pahlı lama R:0,3

** Köşeleri pahlı lama R:3

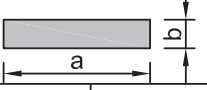
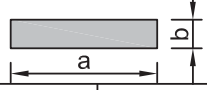

*** Köşeleri pahlı lama R:0,5

DİKKAT: Bu sayfada yer alan profiller için en az sipariş miktarı 300 kg dır./ Minimum order quality: 300 kg

Uyarı: Profil ağırlıklarımız teorik olup; teslim anındaki tartımız geçerlidir.

Warning: The weights of profile is theoretical, weighting at the time of delivery are valid.

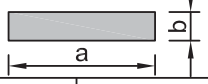
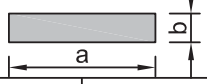
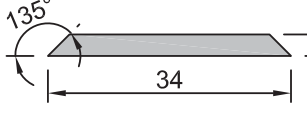
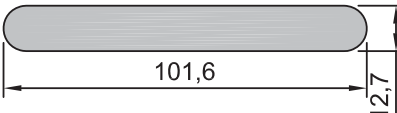
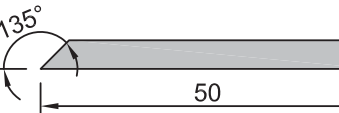
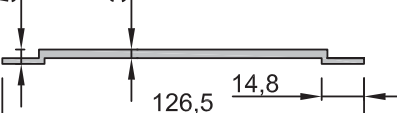
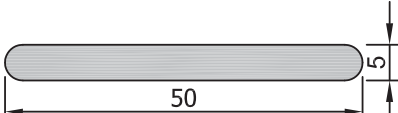
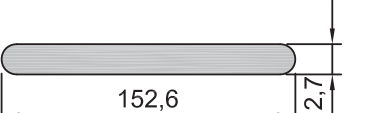
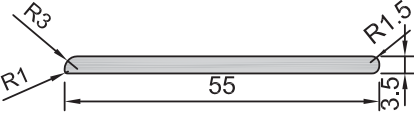
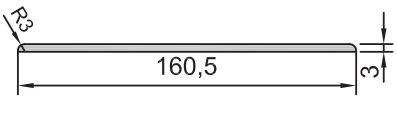
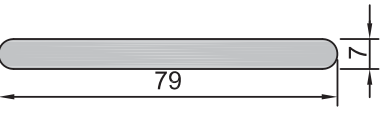
• STANDART PROFİLLER

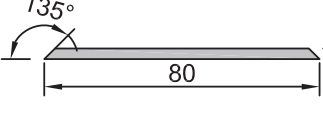
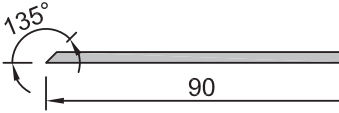
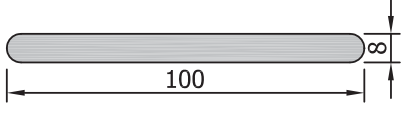
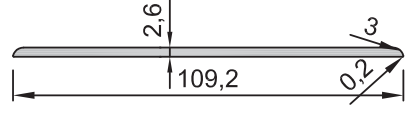
Profil No Profile No		B. Ağırlık Weight (kg/m)	Profil No Profile No		B. Ağırlık Weight (kg/m)
	a (mm) b (mm)			a (mm) b (mm)	
420		0,260	469		3,410
421		0,610	408		0,990
486		0,670	2832		5,150
463		0,520	453		1,300
482		1,475	11049		0,190
455		0,635			
424		0,720			
485		2,140			
483		0,770			

DİKKAT: Bu sayfada yer alan profiller için en az sipariş miktarı 300 kg dır./ Minimum order quality: 300 kg

Uyarı: Profil ağırlıklarımız teorik olup; teslim anındaki tartımız geçerlidir.

Warning: The weights of profile is theoretical, weighting at the time of delivery are valid.

• STANDART PROFİLLER

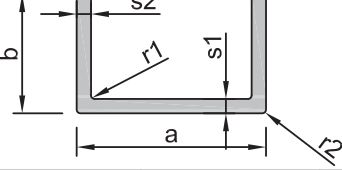
Profil No Profile No							B. Ağırlık Weight (kg/m)
	a (mm)	b (mm)	s1 (mm)	s2 (mm)	r1 (mm)	r2 (mm)	
2813	12,5	28	1	1	-----	-----	0,185
809	17	17	1,2	1,2	-----	-----	0,160
808	20	20	1,2	1,2	-----	-----	0,195
843	20	20	1,8	1,8	-----	-----	0,285
847***	20	40	3	3	0,5	0,5	0,770
10445	22	18,5	1,5	1,5	-----	-----	0,230
829	25	40	2,5	2,5	-----	-----	0,680
803	27,6	30	5	2,5	-----	3	0,715
813	30	20	2	2	-----	-----	0,365
828	30	40	2,5	2,5	-----	-----	0,715
2940	32	27	2	2	-----	-----	0,450
841	34	52	2	2	-----	-----	0,730
839	40	35	4	4	-----	-----	1,110
801	40	40	4	4	-----	-----	1,215
827	40	50	3	3	-----	-----	1,100
842	45	61,2	1,2	1,2	-----	-----	0,540
804	47	30	5	2,5	-----	-----	0,985
820	50	13	1,5	1,5	-----	-----	0,310
3732**	50	30	1,5	1,5	-----	-----	0,440
844	75	6	1,2	1,2	-----	-----	0,285
845	75	18	1,2	1,2	-----	-----	0,360
831	97	40	1,5	1,5	-----	-----	0,720
830	100	10	1,2	1,2	-----	-----	0,390
3456	100	40	1,9	1,9	-----	-----	0,910
814	100	60	2	2	-----	-----	1,180
816	120	20	1,5	1,5	-----	-----	0,650
818	120	20	1,5	1,5	1	2,5	0,640
846	165	65	2	2	-----	-----	1,585

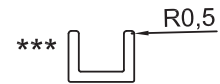
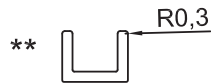
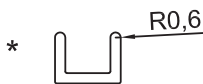

DİKKAT: Bu sayfada yer alan profiller için en az sipariş miktarı 300 kg dır./ Minimum order quality: 300 kg

Uyarı: Profil ağırlıklarımız teorik olup; teslim anındaki tartımız geçerlidir.

Warning: The weights of profile is theoretical, weighting at the time of delivery are valid.

• STANDART PROFİLLER

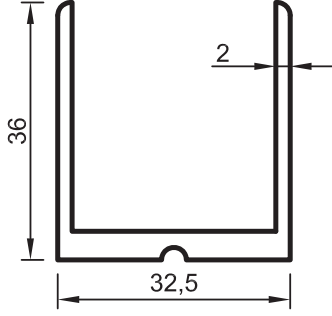

No : 822
0,700 kg/m

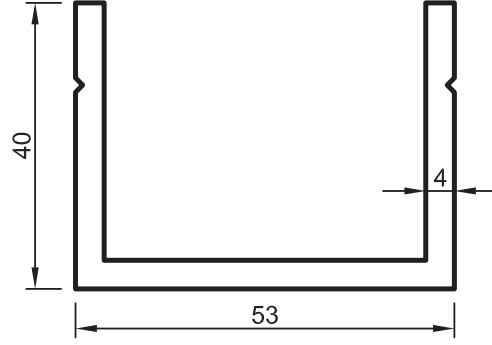

No : 3545
1,350 kg/m

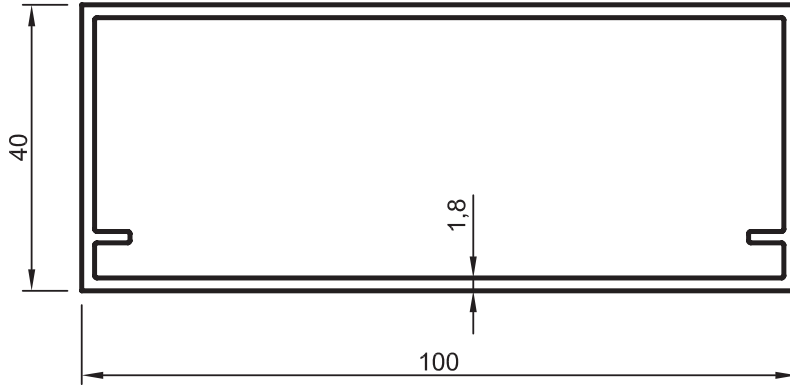

No : 12337
1,375 kg/m

DİKKAT: Bu sayfada yer alan profiller için en az sipariş miktarı 300 kg dır./ Minimum order quality: 300 kg

Uyarı: Profil ağırlıklarımız teorik olup; teslim anındaki tartımız geçerlidir.

Warning: The weights of profile is theoretical, weighting at the time of delivery are valid.

- STANDART PROFİLLER

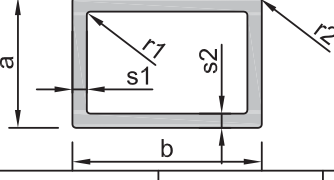
Profil No Profile No							B. Ağırlık Weight (kg/m)
	a (mm)	b (mm)	s1 (mm)	s2 (mm)	r1 (mm)	r2 (mm)	
912	10	20	1,5	1,5	-----	-----	0,230
11549	14	14	2	2	-----	1	0,260
12395	14	25	2	2	-----	1	0,380
933	16,4	16,4	1,2	1,2	-----	-----	0,210
568	17	17	2,5	2,5	-----	-----	0,400
914	17	25	1,2	1,2	-----	-----	0,265
914-B	17	25	2	2	-----	-----	0,420
960	20	20	1,2	1,2	-----	-----	0,250
13162	20	30	1,3	1,3	-----	-----	0,335
965	20	30	2,5	2,5	-----	1	0,615
911	20	40	1,2	1,2	-----	-----	0,380
911-B	20	40	1,8	1,8	-----	-----	0,560
13591	20	40	2	2	-----	-----	0,610
957	20	50	1,5	1,5	-----	-----	0,550
958	20	60	1,5	1,5	-----	-----	0,630
972	20	70	1,5	1,5	-----	-----	0,710
959	20	80	1,3	1,3	-----	-----	0,700
946	20	100	1,6	1,6	-----	-----	1,020
835	25	25	2	2	-----	1	0,500
954	25	25	2,2	2,2	0,3	0,5	0,550
825-B	25	25	2,5	2,5	-----	-----	0,610
944	25	40	2	2	0,5	0,5	0,670
12071	25	60	2	2	-----	-----	0,880
945	25	60	3	3	-----	0,5	1,290
940	30	30	1,2	1,2	-----	-----	0,380
919	30	40	1,2	1,2	-----	-----	0,410
936	30	40	3	3	-----	-----	1,050
943	30	50	3	3	-----	-----	1,265
11583	30	60	2	2	-----	-----	0,935
3201	30	80	2	2	1	3	1,135
967	30	90	1,2	1,2	-----	-----	0,770
930	30,5	59,5	2	2	2	2	0,940
917	32	75	1,2	1,2	-----	-----	0,680
917-1.6	32	75	1,6	1,6	-----	-----	0,905
917-2	32	75	2	2	-----	-----	1,125
917-3	32	75	3	3	-----	-----	1,650
947	35	35	2	2	-----	-----	0,720
931	35	64	1,8	1,8	2	2	0,940
932	38,5	38,5	2,25	2,25	-----	-----	0,890
910	40	40	1,2	1,2	-----	-----	0,510
902-B	40	40	1,8	1,8	-----	-----	0,750
910-B	40	40	1,9	1,9	-----	-----	0,790

DİKKAT: Bu sayfada yer alan profiller için en az sipariş miktarı 300 kg dir./ Minimum order quality: 300 kg

Uyarı: Profil ağırlıklarımız teorik olup; teslim anındaki tartımız geçerlidir.

Warning: The weights of profile is theoretical, weighting at the time of delivery are valid.

• STANDART PROFİLLER

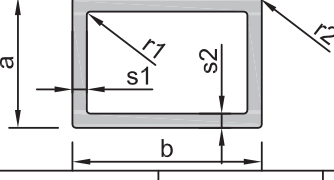
Profil No Profile No							B. Ağırlık Weight (kg/m)
	a (mm)	b (mm)	s1 (mm)	s2 (mm)	r1 (mm)	r2 (mm)	
951	40	40	2,5	2,5	2	2	1,020
964	40	40	3	3	0,5	3,5	1,180
913	40	50	1,2	1,2	-----	-----	0,575
913-B	40	50	1,8	1,8	-----	-----	0,845
926	40	60	1,3	1,3	-----	-----	0,690
926-B	40	60	1,8	1,8	-----	-----	0,950
11150	40	60	3	3	-----	-----	1,530
956	40	60	4	4	1	5	1,950
922	40	80	1,4	1,4	-----	-----	0,900
11853	40	100	1,7	1,7	-----	-----	1,260
975	40	120	1,7	1,7	-----	-----	1,445
939	45	90	2,5	2,5	-----	1	1,770
927	50	50	2	2	2	2	1,050
5097	50	65	2	2	1,5	3,5	1,185
925	50	90	1,5	1,5	-----	-----	1,120
950	50	90	4	5	-----	-----	3,310
920	50	95	1,5	1,5	-----	-----	1,160
974	50	100	1,9	1,9	-----	-----	1,510
11574	50	125	2	2	-----	-----	1,855
942	50	150	2	2	-----	-----	2,130
973	50	200	2	2	-----	-----	2,670
11563	50	280	2,5	2,5	-----	-----	4,405
916	60	60	1,1	1,1	-----	-----	0,710
941 veya 916-B	60	60	2	2	-----	-----	1,270
948	60	60	3,75	3,75	-----	-----	2,295
10755	60	120	1,80	1,80	-----	-----	1,725
963	65	65	2	2	-----	-----	1,375
10978	70	150	2	2	-----	-----	2,345
952	80	80	2	2	-----	-----	1,700
953	80	80	4	4	-----	-----	3,300
13453	80	120	2	2	-----	-----	2,125
3467	86	120	4	2,5	-----	-----	3,390
968	100	100	2	2	-----	-----	2,125
1021-R	100	100	4	4	5	9	4,040
1021-D	100	100	4	4	5	-----	4,230
961	100	150	2,2	2,2	-----	2	2,930
949	120	120	4	4	-----	-----	5,040
10617	150	150	3	3	-----	-----	4,785
11085	150	150	4	4	0,5	1	6,330
962	152	152	4,5	4,2	5,5	10	7,040

DİKKAT: Bu sayfada yer alan profiller için en az sipariş miktarı 300 kg dır./ Minimum order quality: 300 kg

Uyarı: Profil ağırlıklarımız teorik olup; teslim anındaki tartımız geçerlidir.

Warning: The weights of profile is theoretical, weighting at the time of delivery are valid.

• STANDART PROFİLLER

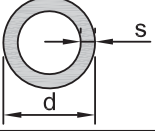
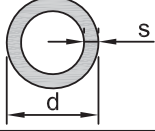
Profil No Profile No			B. Ağırlık Weight (kg/m)	Profil No Profile No			B. Ağırlık Weight (kg/m)
	d (mm)	s (mm)			d (mm)	s (mm)	
1261	12	3,5	0,255	10491	35	2	0,565
1245	14	3	0,285	1131 #	35	2,5	0,700
1293	15,8	1,3	0,165	1132	35	3	0,825
1296 #	15,8	1,5	0,190	1272	35	14,25	2,525
3325 #	15,8	1,9	0,230	1272	35	14,25	2,525
10785	15,8	3	0,330	1136	36	3	0,850
1266 #	15,8	4,9	0,460	1139	37	2,5	0,740
1235	18,4	1,8	0,255	1140	37	3	0,875
1280	19	1,25	0,195	1143	38	2,5	0,765
1102 #	19	1,5	0,230	1144	38	3	0,900
1103	19	2	0,300	1146	39	1,5	0,480
1105	20	1,5	0,245	1147	39	2,5	0,785
1104	20	2	0,310	1148	39	3	0,930
1108	21	1,5	0,260	1260 #	40	2	0,650
1109	21	2	0,330	1152 #	40	2,5	0,810
1111	22	1,5	0,270	1153	40	3	0,950
1227	22	2	0,345	1276	40	4,75	1,435
1112	22	5	0,730	1271	40	15	3,200
1256	23	1,5	0,275	1156	41	2,5	0,820
1264	23	4	0,650	1157	41	3	0,975
1263	23	5,5	0,820	1160	42	2,5	0,845
1262	23	6,5	0,915	1161	42	3	1,000
1258	24	2	0,380	1164	43	2,5	0,865
1118 #	25	1,5	0,310	1165	43	3	1,025
1119	25	2	0,400	1168	44	2,5	0,885
1257	25	2,5	0,480	1169	44	3	1,050
1120	25	5	0,860	1171	45	1,5	0,565
1259	26	3	0,590	1172	45	2,5	0,910
1121	26	9,25	1,325	1173	45	3	1,080
1247	29	2	0,460	1294	45	7,5	2,400
1244	30	2	0,480	1176	46	2,5	0,930
1127	30	2,5	0,595	1177	46	3	1,110
11356	30	3	0,690	1180	47	2,5	0,950
1275	30	10	1,710	1181	47	3	1,125
1126	34	2,5	0,670	1183	48	1,5	0,600
1128	34	3	0,800	1250	48	2	0,785

DİKKAT: # İşaretili kalemler hariç; bu sayfada yer alan profiller için en az sipariş miktarı 300 kg dir./ Minimum order quality: 300 kg

Uyarı: Profil ağırlıklarımız teorik olup; teslim anındaki tartımız geçerlidir.

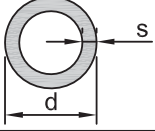
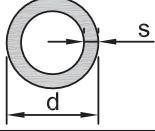

Warning: The weights of profile is theoretical, weighting at the time of delivery are valid.

• STANDART PROFİLLER

Profil No Profile No			B. Ağırlık Weight (kg/m)	Profil No Profile No			B. Ağırlık Weight (kg/m)
	d (mm)	s (mm)			d (mm)	s (mm)	
1184	48	2,5	0,970	12000	72	3	1,765
1185	48	3	1,155	1277	72	16	7,640
1248	49	2	0,800	1213	75	2	1,250
1188	49	2,5	0,990	1231	76	15,6	8,030
1189	49	3	1,175	1222	80	1,5	1,010
1191 #	50	1,5	0,625	1224	80	2	1,335
1295 #	50	1,8	0,740	1278	82	16	8,995
1249 #	50	2	0,830	1215	86	2	1,440
1192 #	50	2,5	1,020	1234	89	2,2	1,630
1193	50	3	1,210	1279	90	13,5	8,800
1269	50	10	3,415	1228	93	19,2	12,070
1195	51	1,5	0,640	1267	99,5	2,75	2,275
1196	51	2,5	1,040	1217	100	2	1,670
1197	51	3	1,230	1216	100	4	3,280
1251	52	2	0,851	1225	102	2	1,710
1200	52	2,5	1,055	1220	106	2	1,775
1201	52	3	1,255	1221	110	1,5	1,395
1204	53	2,5	1,075	1239	110	11,25	9,830
1205	53	3	1,280	1236	115	3	2,865
613	54	1,5	0,680	1226	125	2,5	2,620
1208	54	2,5	1,100	1268	120	6	5,830
1209	54	3	1,305	1237	130	3	3,250
1274	55	2,35	1,060	1230	150	3	3,760
1214	56	2	0,920	10551	150	4	4,975
1252	57	1,5	0,715	10552	165	3	4,140
1243	60	1,2	0,610	10553	180	4	5,995
1240 #	60	2	0,990	10459	200	8	13,080
1241	60	3	1,460	1282	200	10	16,185
1242	60	4	1,915	10451-2,5	254	2,5	5,360
1270	60	19,75	6,775				
1273	63,5	2	1,055				
1253	64	2	1,060				
1223	64	10	4,610				
1291	65	2,5	1,335				
886	70	1,5	0,880				

DİKKAT: # İşaretili kalemler hariç; bu sayfada yer alan profiller için en az sipariş miktarı 300 kg dir./ Minimum order quality: 300 kg
 Uyarı: Profil ağırlıklarımız teorik olup; teslim anındaki tartımız geçerlidir.
 Warning: The weights of profile is theoretical, weighting at the time of delivery are valid.

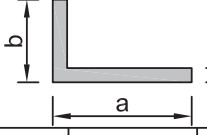
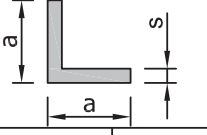
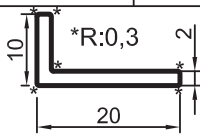
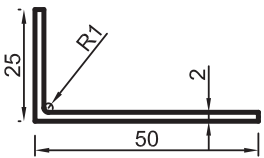
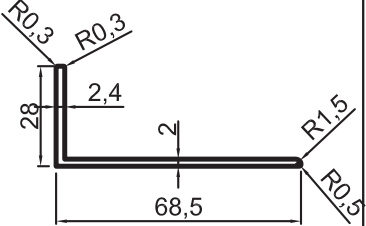
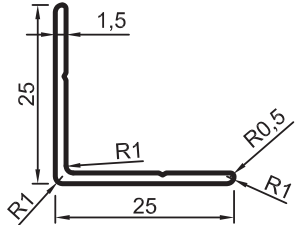
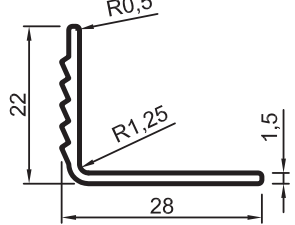
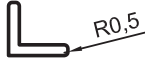
• STANDART PROFİLLER

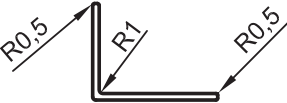
Profil No Profile No				B. Ağırlık Weight (kg/m)	Profil No Profile No				B. Ağırlık Weight (kg/m)
	a (mm)	b (mm)	s (mm)			a (mm)	b (mm)	s (mm)	
1307	15	10	2	0,130	1401 #	15	15	1,5	0,120
1308	20	15	4	0,340	1402	20	20	1,2	0,130
1309	25	15	3	0,310	1418	20	20	2	0,215
1328	25	20	2	0,240	1414	25	25	1,2	0,160
1301	30	10	4	0,395	1403	25	25	1,5	0,210
1302	30	15	1,5	0,185	1411	25	25	3	0,385
1303	30	15	2	0,240	1421	25	25	4	0,510
1431	30	20	1,2	0,160	1413 #	30	30	1,3	0,215
1320	30	20	4	0,505	1406	30	30	1,5	0,245
1329	30	25	2	0,290	1407	30	30	2	0,320
1331***	35	27	1,85	0,305	1405	30	30	3	0,470
1318 #	40	20	1,2	0,200	1420	35	35	3	0,550
1312	40	20	1,5	0,240	1408 #	40	40	2	0,430
1312/B	40	20	2	0,320	1409 #	40	40	4	0,830
1304	40	20	3	0,470	1428	50	50	2	0,540
1427					1410 #	50	50	5	1,295
10308	40	30	2	0,370	1325	60,2	60,2	5	1,570
1317	50	18	2,5	0,450	1417	100	100	4	2,130
1321	50	20	1,5	0,285	 <p>No : 1324 0,155 kg/m</p>  <p>No : 9519 0,400 kg/m</p>  <p>No : 1330 0,545 kg/m</p>  <p>No : 4688 0,200 kg/m</p>  <p>No : 4799 0,215 kg/m</p>				
1430	50	25	4	0,775					
1305	60	15	1,8	0,365					
1316 #	60	20	1,5	0,330					
1313	60	20	1,8	0,390					
1306	60	30	2	0,480					
10142	60	40	1,8	0,485					
1310	70	50	2	0,650					
12887	80	20	1,4	0,375					
12888	100	20	1,4	0,455					
1429	100	30	4,5	1,540					
1322	100	70	10	4,340					
1327	115	12	2	0,680					
10748	180	40	3	1,765					
* Köşelerde 0,5 mm radius var.									
** Köşelerde 1,0 mm radius var.									
***Köşelerde radius var.									

DİKKAT: # İşaretili kalemler hariç; bu sayfada yer alan profiller için en az sipariş miktarı 300 kg dir./ Minimum order quality: 300 kg

Uyarı: Profil ağırlıklarımız teorik olup; teslim anındaki tartımız geçerlidir.

Warning: The weights of profile is theoretical, weighting at the time of delivery are valid.