

# MİMARİ KATALOG ARCHITECTURAL CATALOGUE

Alüminyum Kapı Pencere ve Giydirme Cephe Sistemleri  
Aluminium Window Doors and Facade Systems

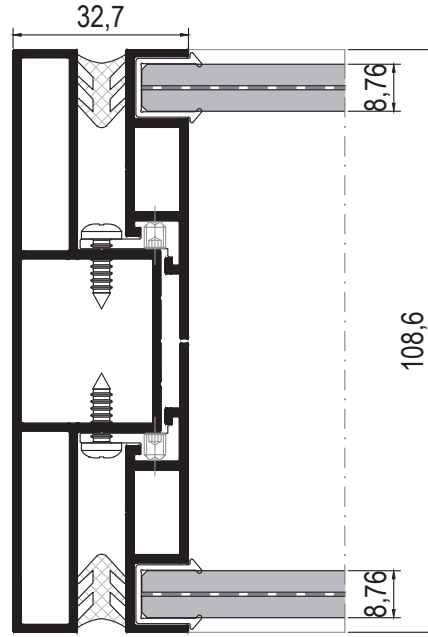

# RO108

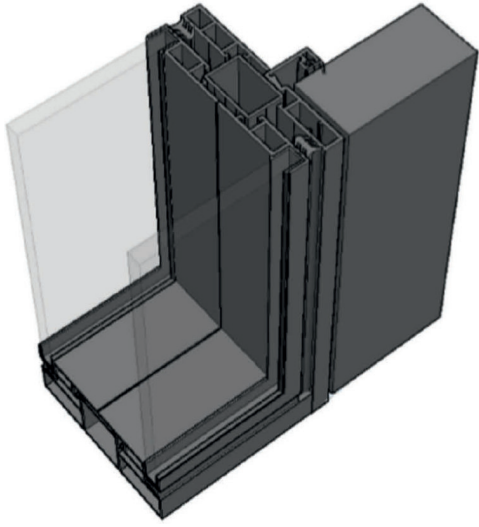

TEKNİK ÖZELLİKLERİ / TECHNICAL PROPERTIES

SİSTEM DERİNLİĞİ / FRAME DEPTH	108,6 mm
SİSTEM YÜKSEKLİĞİ / FRAME HEIGHT	32,4 mm
CAM KALINLIKLARI / GLASS THICKNESS	6 / 8 / 8,76 mm

KULLANIM SEÇENEKLERİ / APPLICATION ALTERNATIVES

ÇİFT CAMLI OFİS BÖLME SİSTEMİ /
AHŞAP KAPI ÇERÇEVE PROFİLİ ALTERNATİFİ /
ÇERÇEVELİ VE ÇERÇEVESİZ BİNİLİ KAPI /
T KÖŞE BİRLEŞİM / T CORNER CONNECTION
Y KÖŞE BİRLEŞİM / Y CORNER CONNECTION
90° KÖŞE DÖNÜŞ / 90° CORNER TURN
120° KÖŞE DÖNÜŞ / 120° CORNER TURN
176° KÖŞE DÖNÜŞ / 176° CORNER TURN
ÇERÇEVELİ VE ÇERÇEVESİZ BİNİLİ KAPI / FRAMED AND UNFRAMED DOOR
KABLO KANALI ALTERNATİFİ / CABLE CHANNEL ALTERNATIVE
DEKORATİF DALGALI KASET PROFİLİ ALTERNATİFİ /
ÇİFT CAM ARASI JALUZİ ALTERNATİFİ /

MİMARİ KATALOG

ARCHITECTURAL CATALOGUE

Alüminyum Kapı Pencere ve Giydirme Cephe Sistemleri  
Aluminium Window Doors and Facade Systems

# RO108

PROFİLLER

PROFILES

01

02

03

04

05

06

07

08

09

10

11

12

13

KOD / CODE	AĞIRLIK (kg/m) / WEIGHT	Jxx cm <sup>4</sup>	Jyy cm <sup>4</sup>	L m	
RO108 F 01	1,171	3,404	41,827	6	
RO108 F 02	0,706	8,405	2,512	6	
RO108 F 04	1,328	49,154	2,381	6	

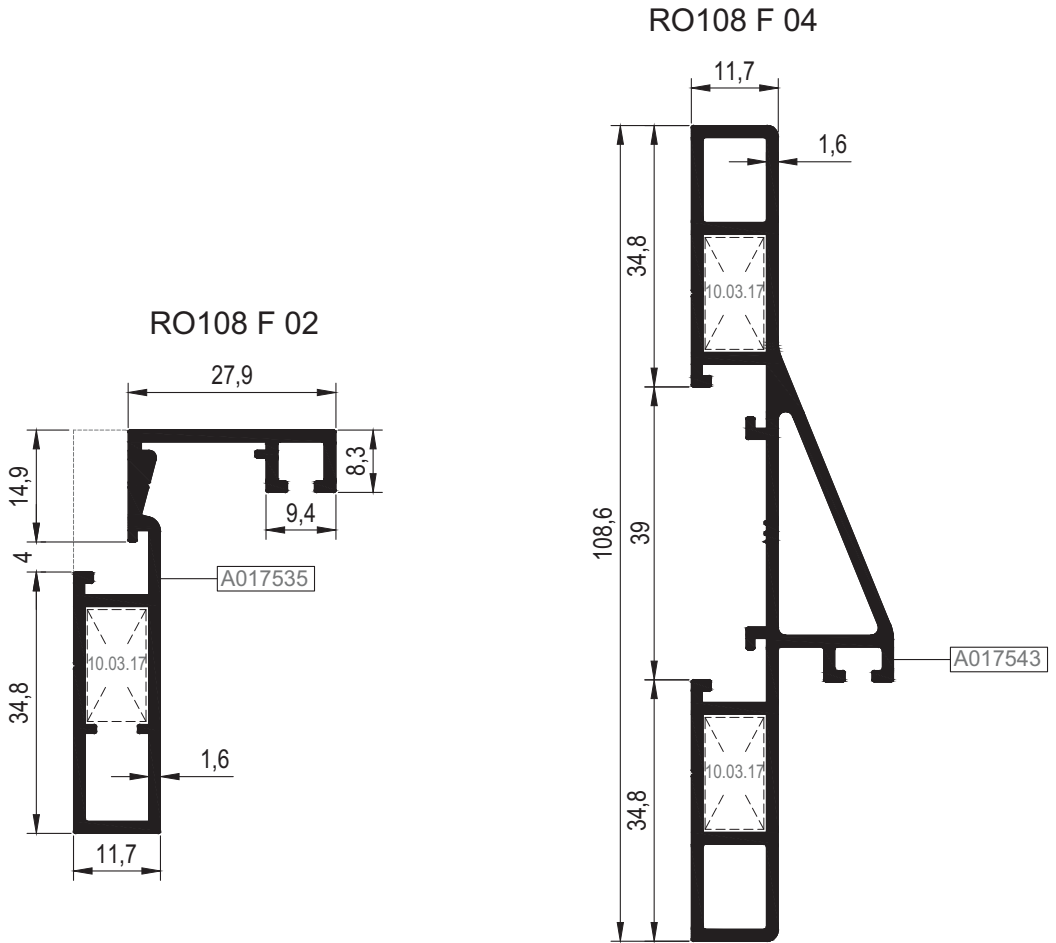
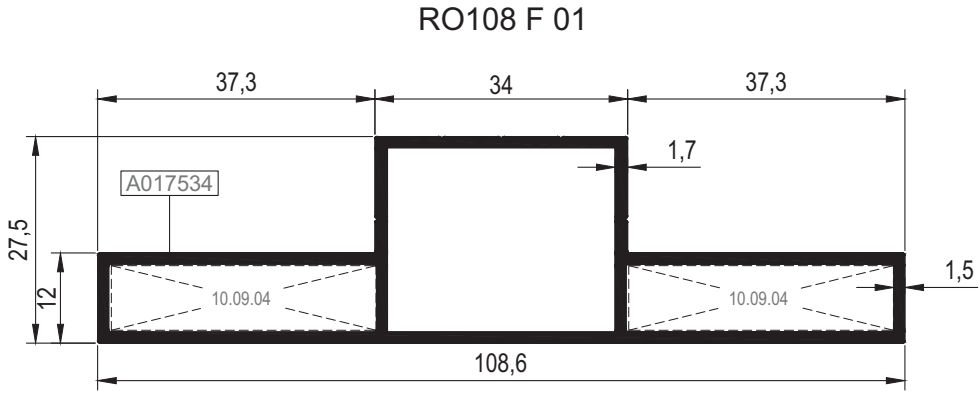

KOD / CODE	AĞIRLIK (kg/m) / WEIGHT	Jxx cm <sup>4</sup>	Jyy cm <sup>4</sup>	L m	
**RO108 F 03	2,424	64,613	86,151	6	

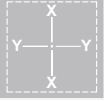

\*\*RO108 F 03

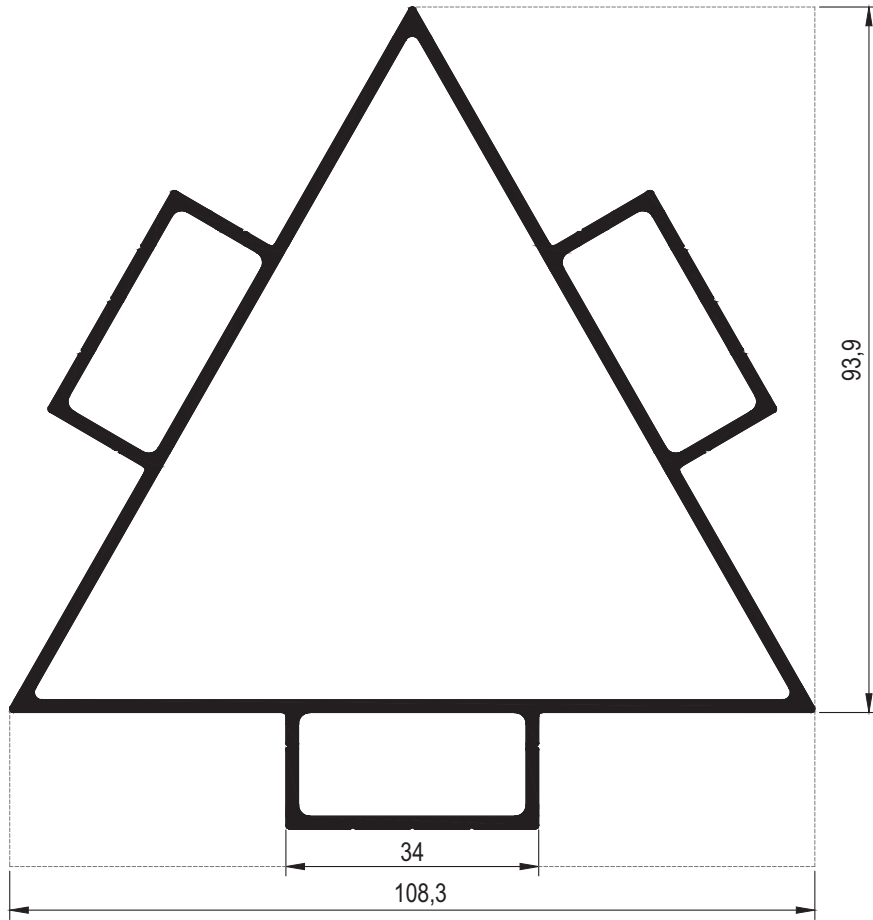

\*\*Kalıp aktif değildir. Sipariş üzerine yapılacaktır.  
The die is not active. It will be produced by order.

01

KOD / CODE	AĞIRLIK (kg/m) / WEIGHT	Jxx cm <sup>4</sup>	Jyy cm <sup>4</sup>	L m	
**R0108 F 05	2,646	----	----	6	

02

03

04

\*\*R0108 F 05

05

06

07

08

09

10

11

12

13

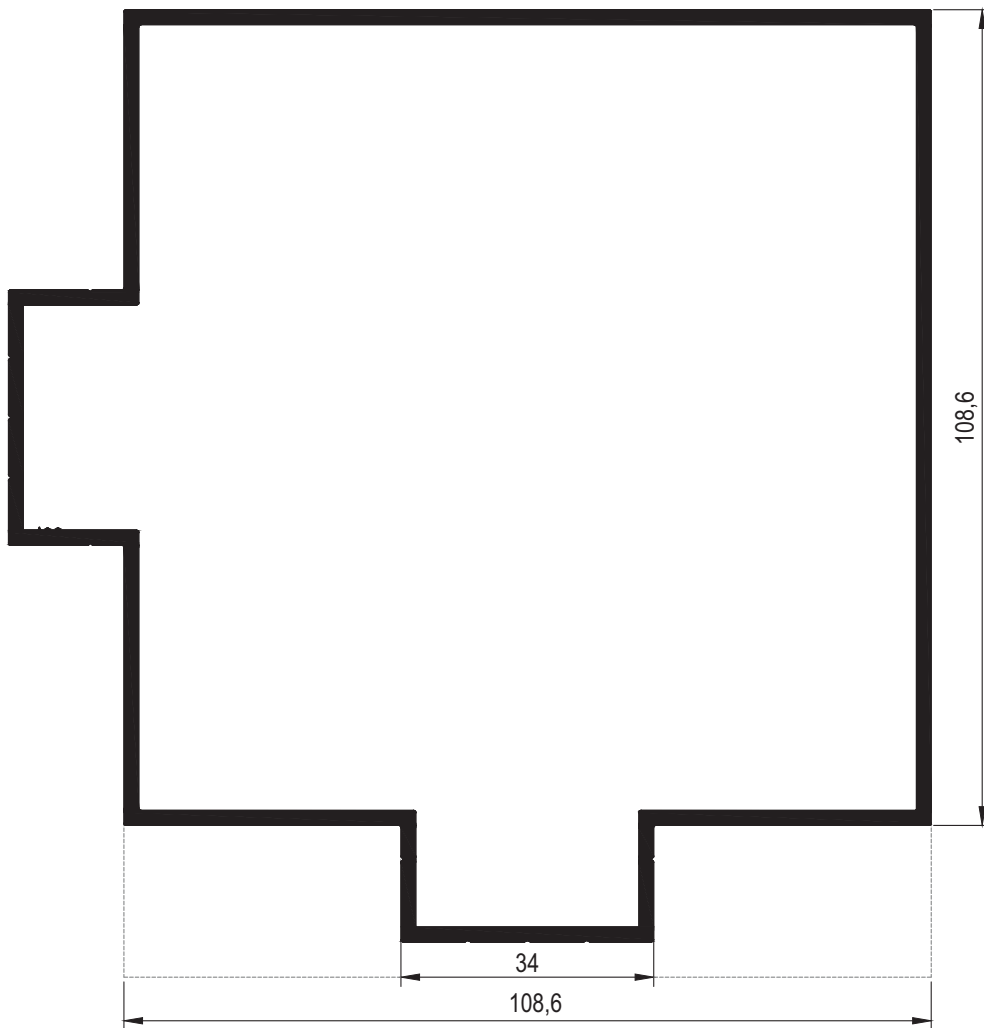

\*\*Kalıp aktif değildir. Sipariş üzerine yapılacaktır.  
The die is not active. It will be produced by order.

KOD / CODE	AĞIRLIK (kg/m) / WEIGHT	Jxx cm <sup>4</sup>	Jyy cm <sup>4</sup>	L m	
**R0108 F 06	2,65	----	----	6	

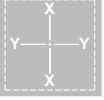

\*\*R0108 F 06

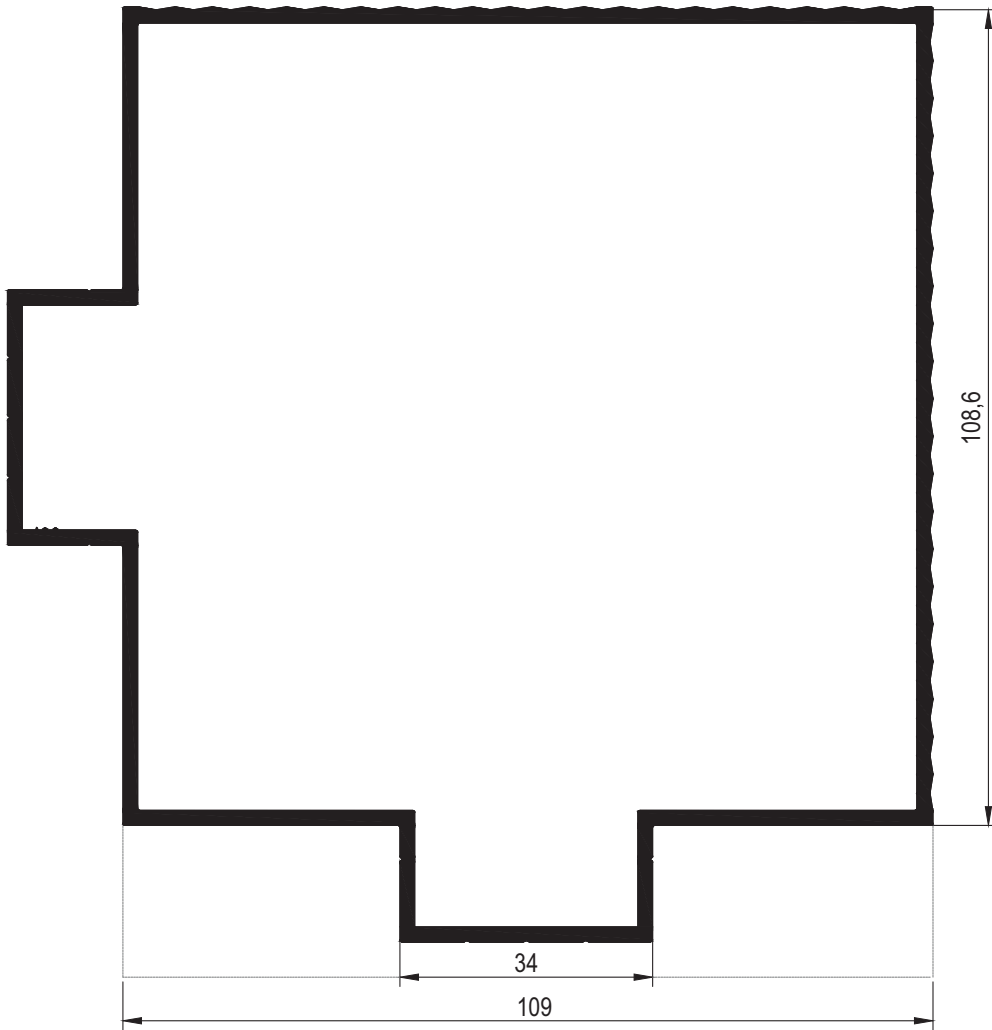

\*\*Kalıp aktif değildir. Sipariş üzerine yapılacaktır.  
The die is not active. It will be produced by order.

KOD / CODE	AĞIRLIK (kg/m) / WEIGHT	Jxx cm <sup>4</sup>	Jyy cm <sup>4</sup>	L m	
RO108 M 01	0,429	2,478	1,237	6	
**RO108 M 02	0,470	----	----	6	
**RO108 A 03	0,138	----	----	6	

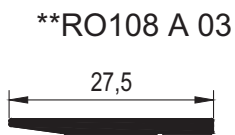
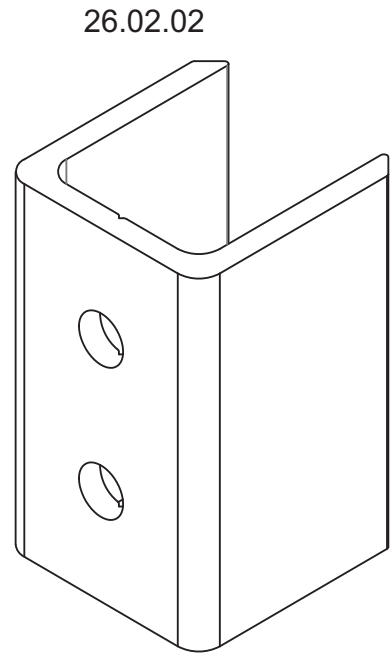
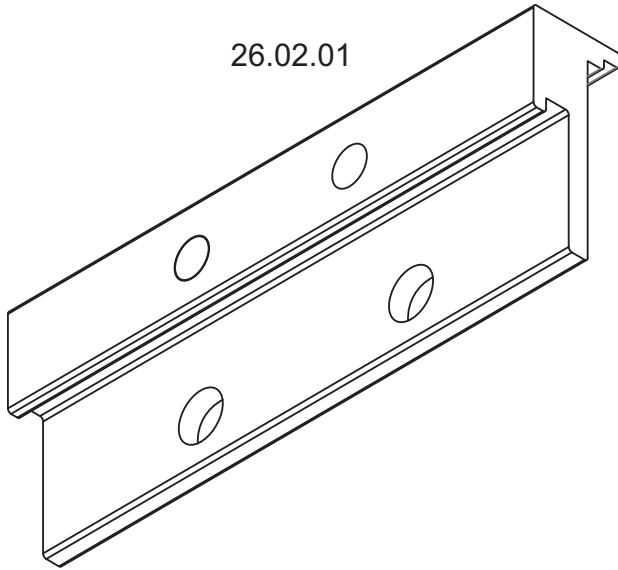
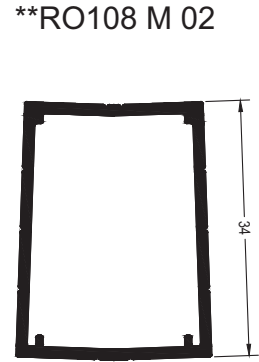
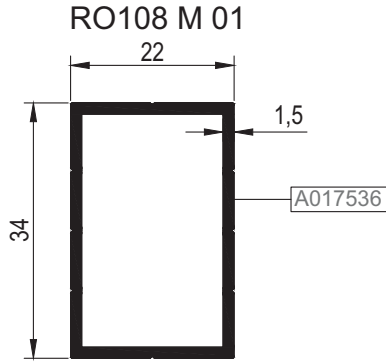

\*\*Kalıp aktif değildir. Sipariş üzerine yapılacaktır.  
The die is not active. It will be produced by order.



KOD / CODE	AĞIRLIK (kg/m) / WEIGHT	Jxx cm <sup>4</sup>	Jyy cm <sup>4</sup>	L m
RO108 V 01	0,457	0,343	3,401	6
RO108 V 02	0,422	0,444	2,215	6
**RO108 V 03	0,543	----	----	6
RO108 V 04	0,515	----	----	6
**RO108 V 07	0,486	0,381	4,014	6
**RO108 V 09	0,400	----	----	6
**RO108 V 10	0,478	----	----	6
**RO108 V 11	0,468	----	----	6



RO108 V 01

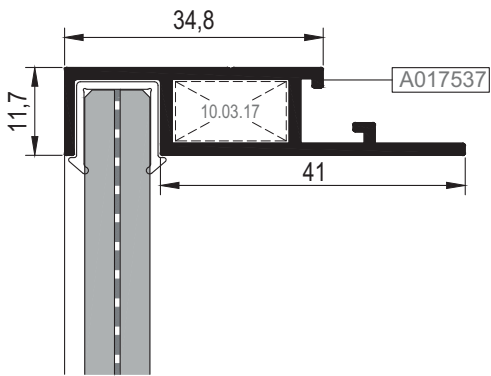

RO108 V 04

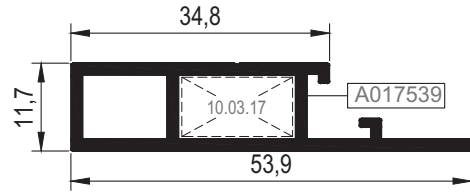

RO108 V 02

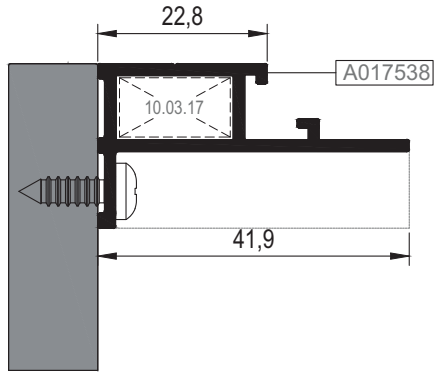

\*\*RO108 V 10

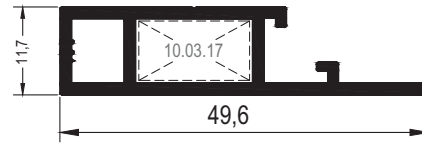

\*\*RO108 V 09

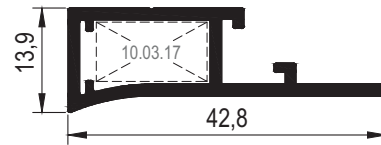

\*\*RO108 V 11

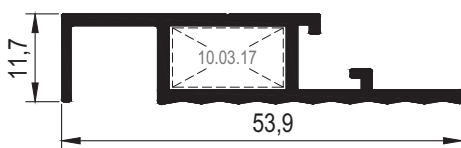

\*\*RO108 V 03

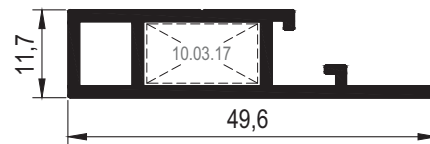

\*\*RO108 V 07

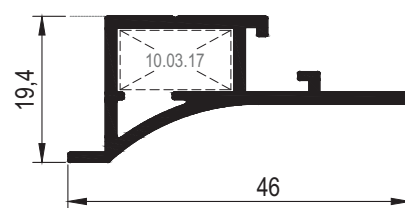

\*\*Kalıp aktif değildir. Sipariş üzerine yapılacaktır.  
The die is not active. It will be produced by order.

KOD / CODE	AĞIRLIK (kg/m) / WEIGHT	Jxx cm <sup>4</sup>	Jyy cm <sup>4</sup>	L m	
RO108 V 05	1,370	12,737	91,364	6	
**RO108 V 06	1,910	-----	-----	6	

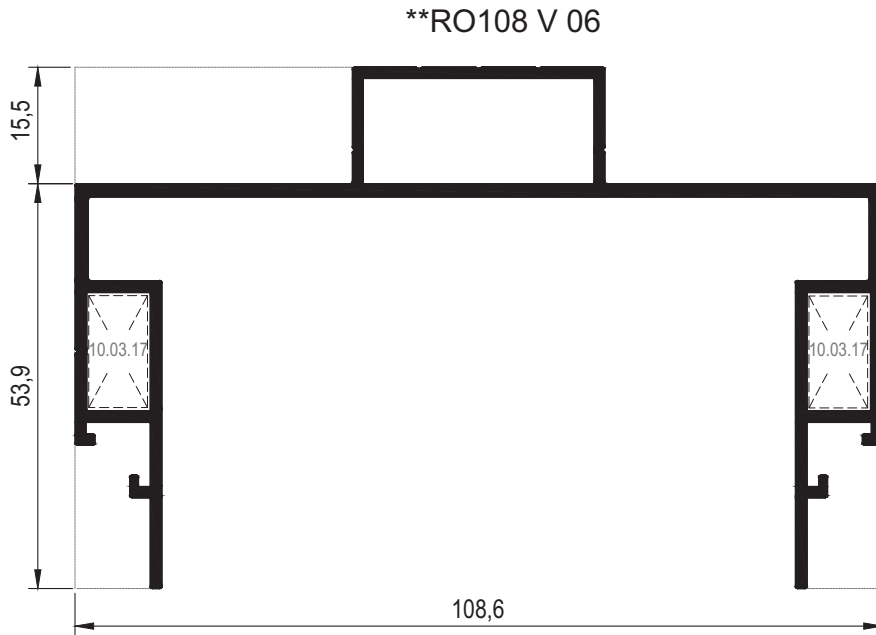
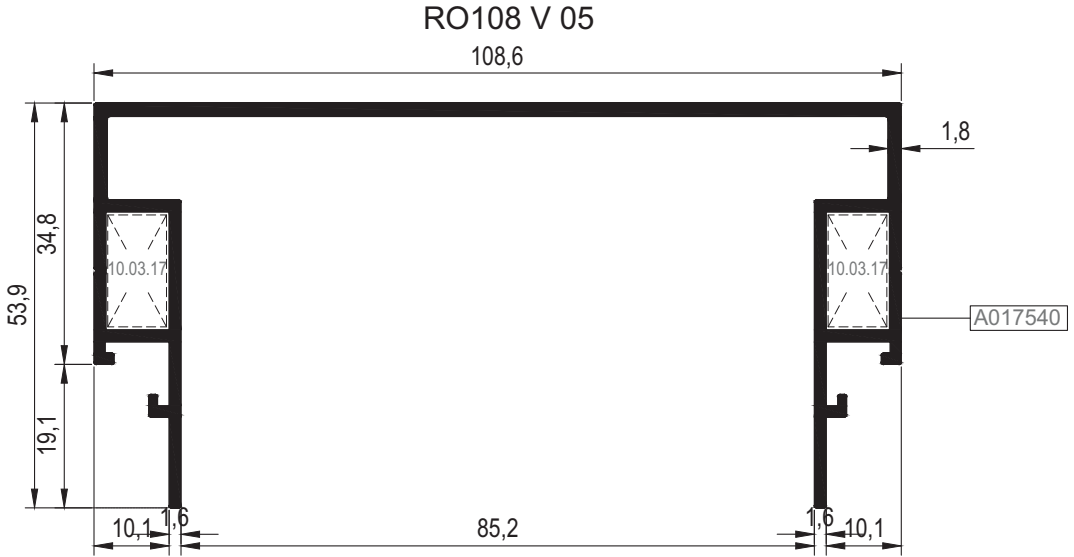

\*\*Kalıp aktif değildir. Sipariş üzerine yapılacaktır.  
The die is not active. It will be produced by order.

KOD / CODE	AĞIRLIK (kg/m) / WEIGHT	Jxx cm <sup>4</sup>	Jyy cm <sup>4</sup>	L m	
RO108 V 08	0,606	1,142	4,297	6	
RO77 V 01	0,269	----	----	6	

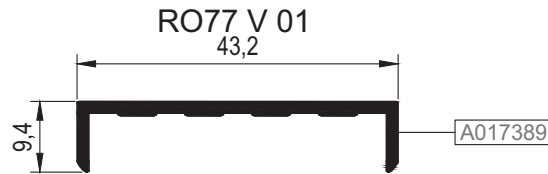
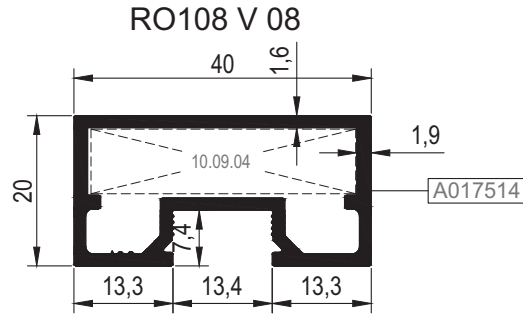

01

02

03

04

05

06

07

08



09

10

11

12

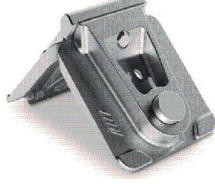
13

AKSESUAR KODU (ACCESSORIES CODE)	10.09.04	10.03.17	
KESİM ÖLÇÜSÜ (CUTTING SIZE)	8,5 mm	7,9 mm	
PROFİL KODU (PROFILE CODE)	Pimli bağlantılı köşe takozu (Corner cleat with pin connection)	Pimli bağlantılı köşe takozu (Corner cleat with pin connection)	
ÇİZİM (DRAWING)			

KÖŞE TAKOZLARI (CORNER CLEATS)			
Nr		KESİM ÖLÇÜSÜ CUTTING SIZE	AKS. KODU ACS. CODE
RO108 F 01	A017534	8,5 mm	10.09.04
		8,5 mm	10.09.04
RO108 F 02	A017535	8,5 mm	10.03.17
RO108 F 04	A017543	8,5 mm	10.03.17
		8,5 mm	10.03.17
RO108 V 01	A017537	8,5 mm	10.03.17
RO108 V 02	A017538	8,5 mm	10.03.17
RO108 V 03	----	8,5 mm	10.03.17
RO108 V 04	A017539	8,5 mm	10.03.17
		8,5 mm	10.03.17
RO108 V 05	A017540	8,5 mm	10.03.17
		8,5 mm	10.03.17
RO108 V 06	----	8,5 mm	10.03.17
		8,5 mm	10.03.17
RO108 V 07	----	8,5 mm	10.03.17
RO108 V 09	----	8,5 mm	10.03.17
RO108 V 10	----	8,5 mm	10.03.17
RO108 V 11	----	8,5 mm	10.03.17
RO108 V 08	A017514	8,5 mm	10.09.04

MİMARİ KATALOG

ARCHITECTURAL CATALOGUE

Alüminyum Kapı Pencere ve Giydirme Cephe Sistemleri  
Aluminium Window Doors and Facade Systems

# RO108

DETAYLAR

DETAILS

01

02

03

04

05

06

07

08

09

10

11

12

13

01

02

03

04

05

06

07

08

09

10

11

12

13

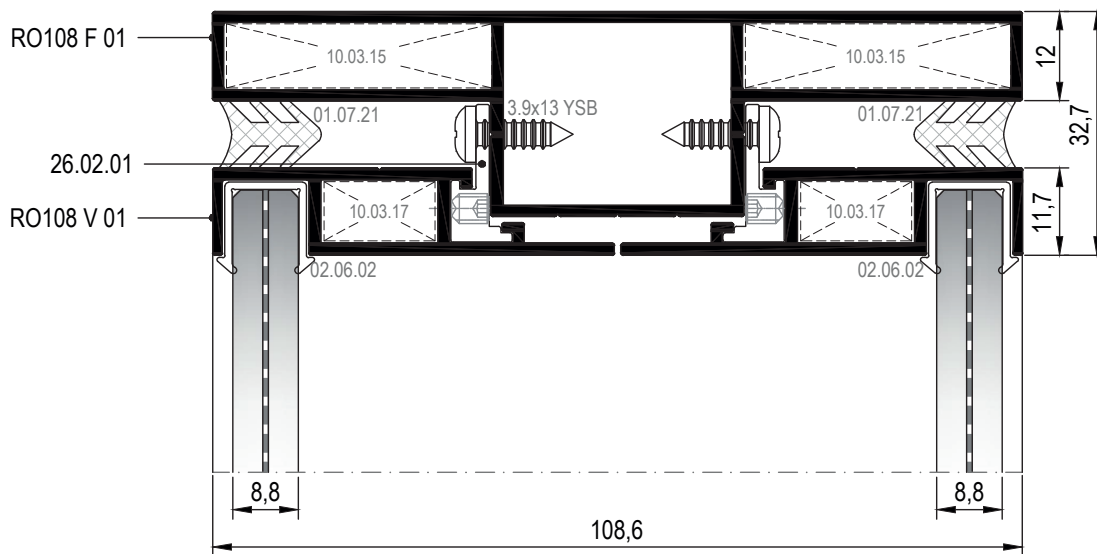
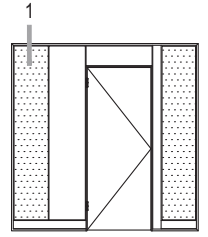

① DETAYI  
DETAIL

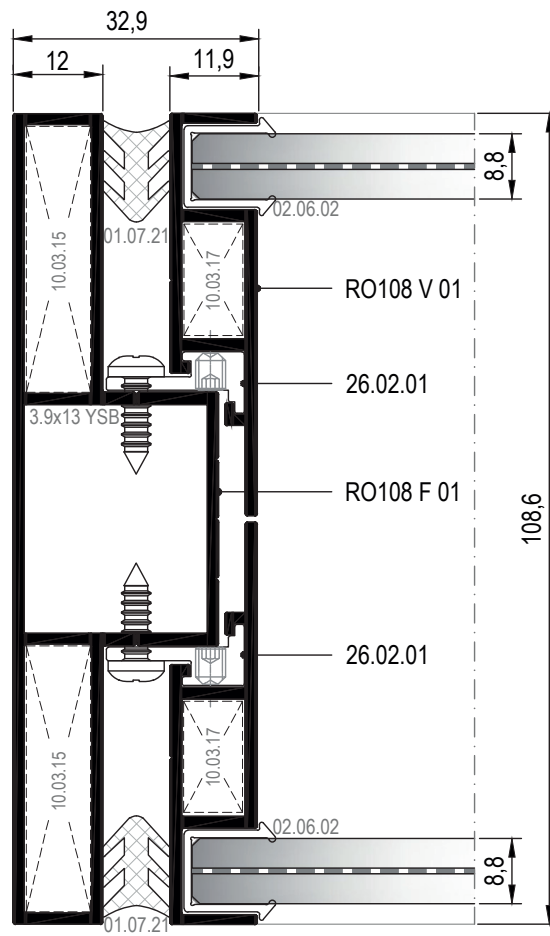
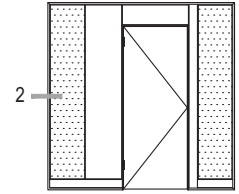

② DETAYI  
DETAIL

01

02

03

04

05

06

07

08

09

10

11

12

13

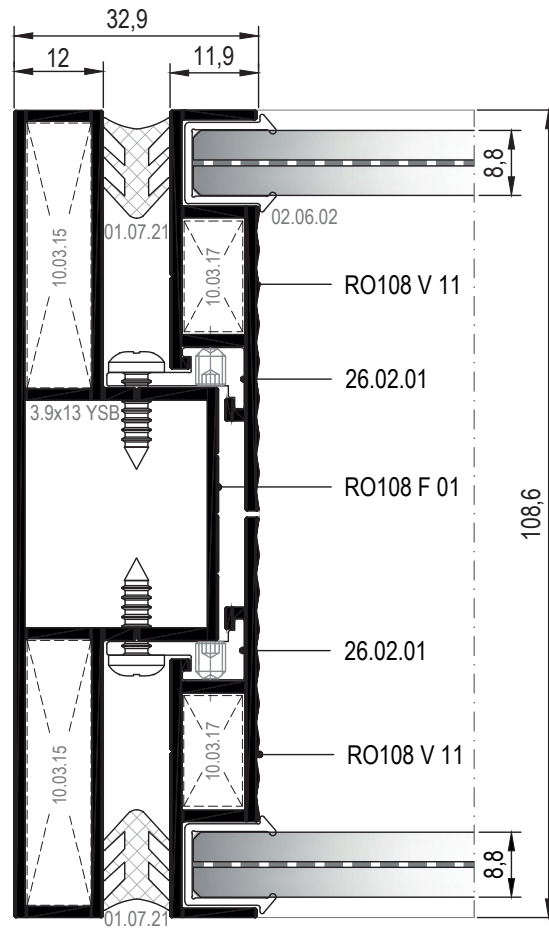
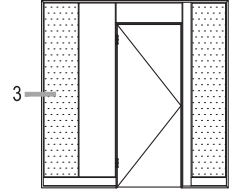

③ DETAYI  
DETAIL



01

02

03

04

05

06

07

08

09

10

11

12

13

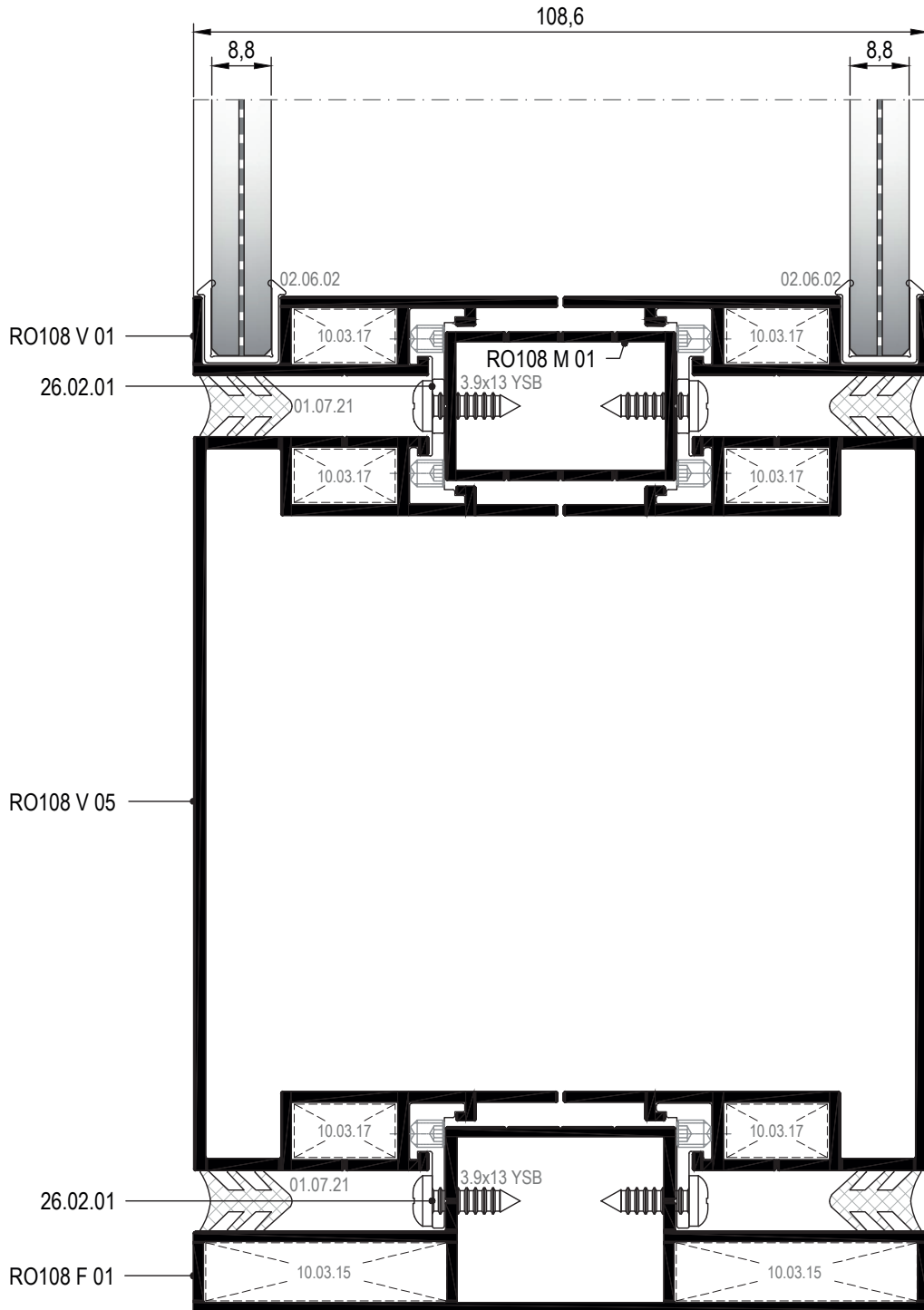

④ DETAYI  
DETAIL

01

02

03

04

05

06

07

08

09

10

11

12

13

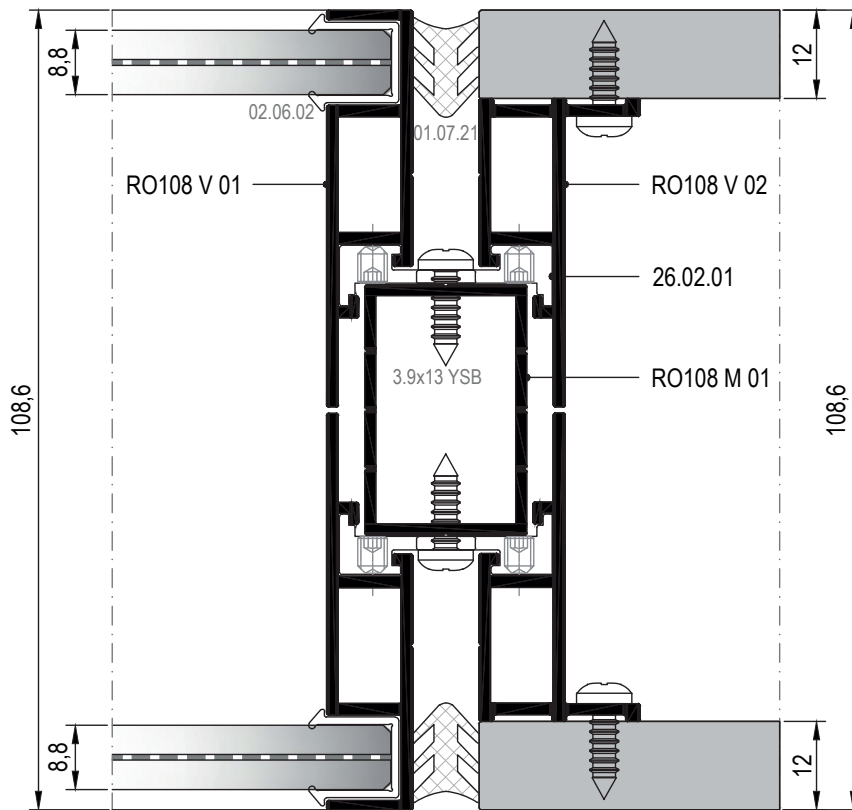
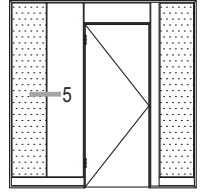

⑤ DETAYI  
DETAIL

01

02

03

04

05

06

07

08

09

10

11

12

13

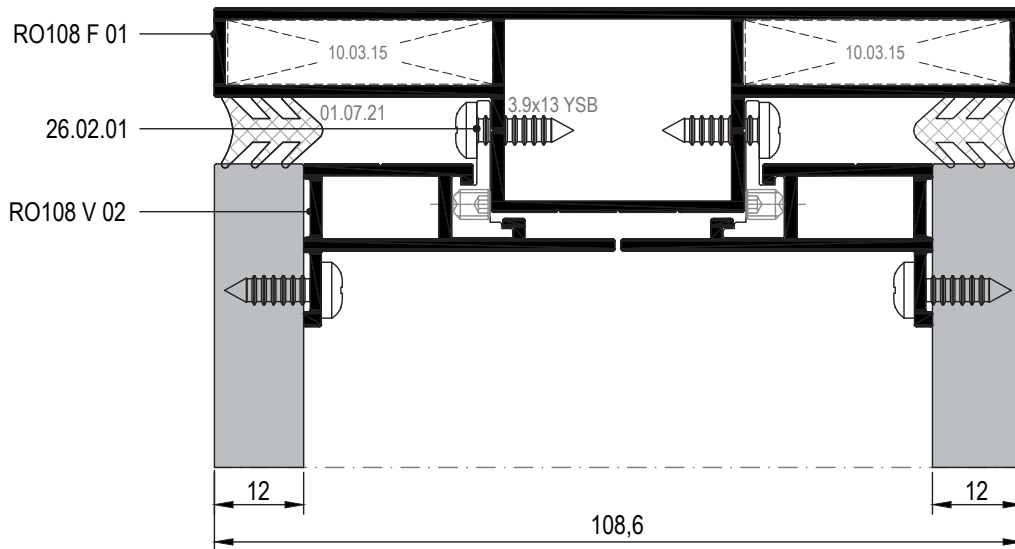
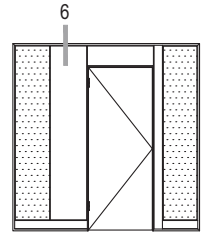

⑥ DETAYI  
DETAIL

01

02

03

04

05

06

07

08

09

10

11

12

13

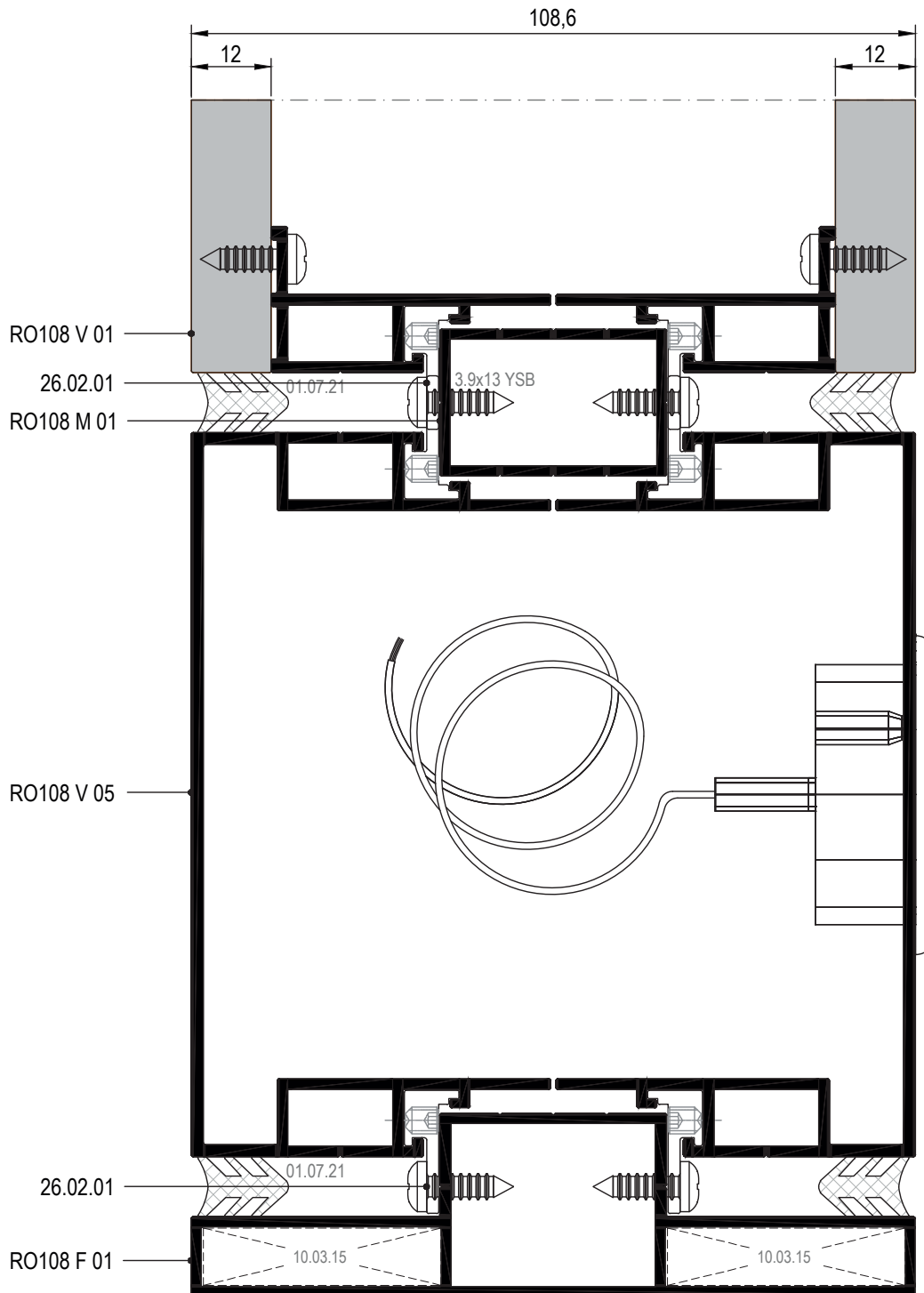
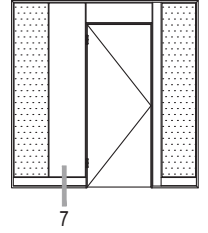

⑦ DETAYI  
DETAIL

01

02

03

04

05

06

07

08

09

10

11

12

13

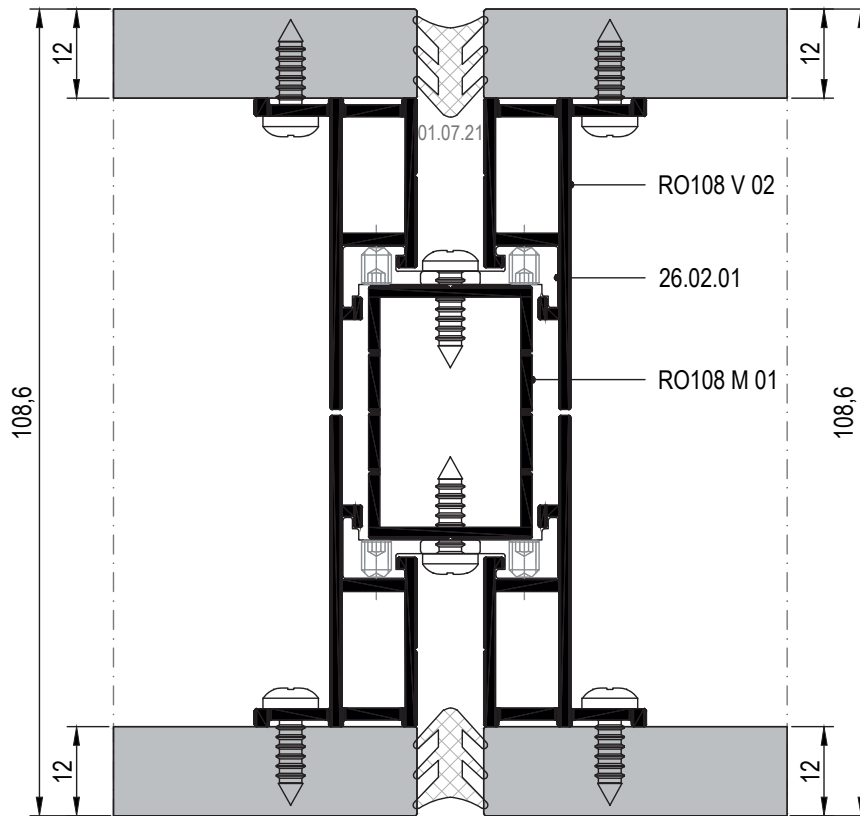
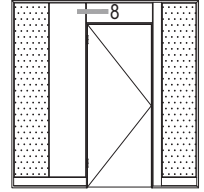

⑧ DETAYI  
DETAIL

01

02

ALÜMİNYUM KASA AHŞAP KAPI DETAYI  
WOOD DOOR WITH ALUMINIUM FRAME DETAIL

03

04

05

06

07

08

09

10

11

12

13

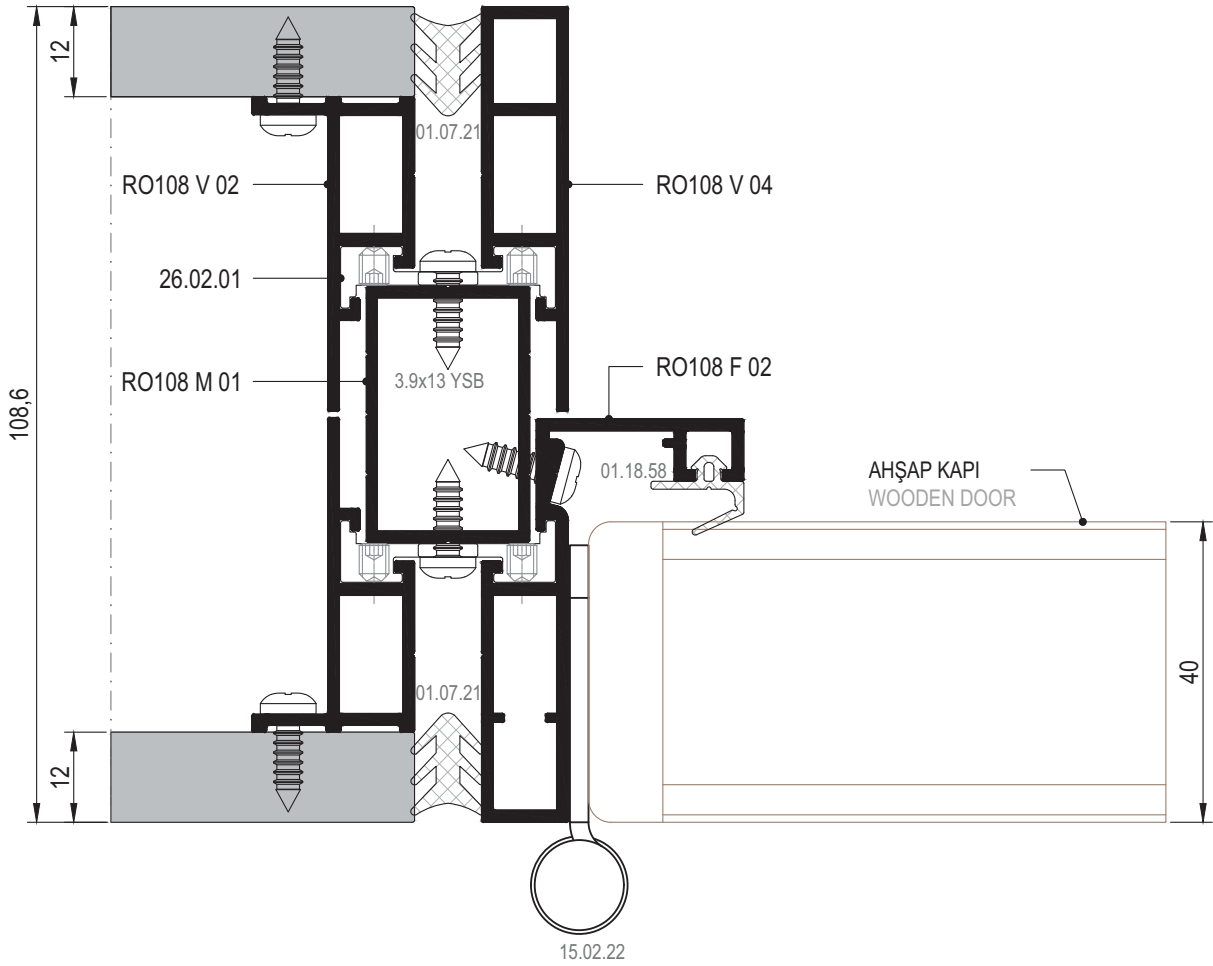
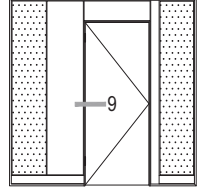

⑨ DETAYI  
DETAIL

ALÜMİNYUM KASA AHŞAP KAPI DETAYI  
WOOD DOOR WITH ALUMINIUM FRAME DETAIL

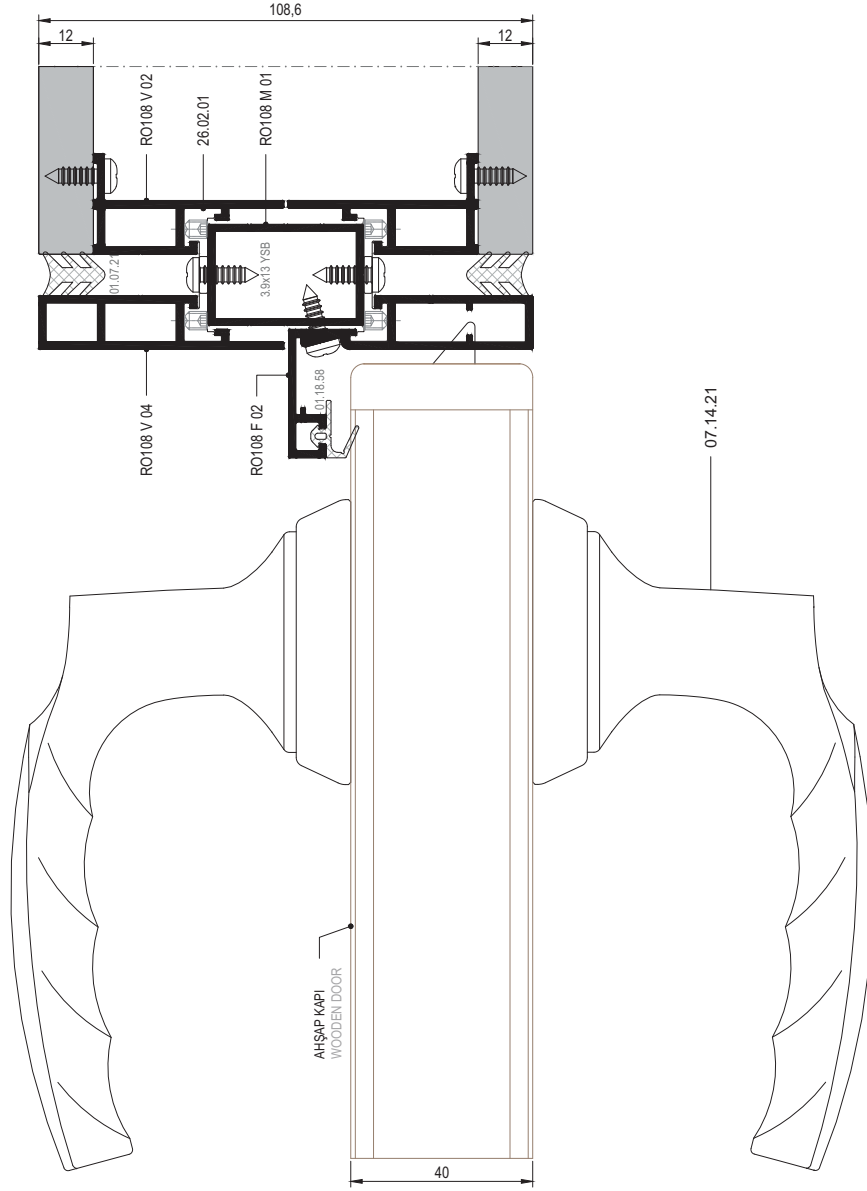
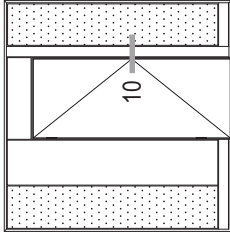

10 DETAYI  
DETAIL

01

02

ALÜMİNYUM KASA AHŞAP KAPI DETAYI  
WOOD DOOR WITH ALUMINIUM FRAME DETAIL

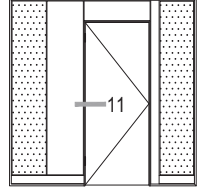

03

04

05

06

07

08

09

10

11

12

13

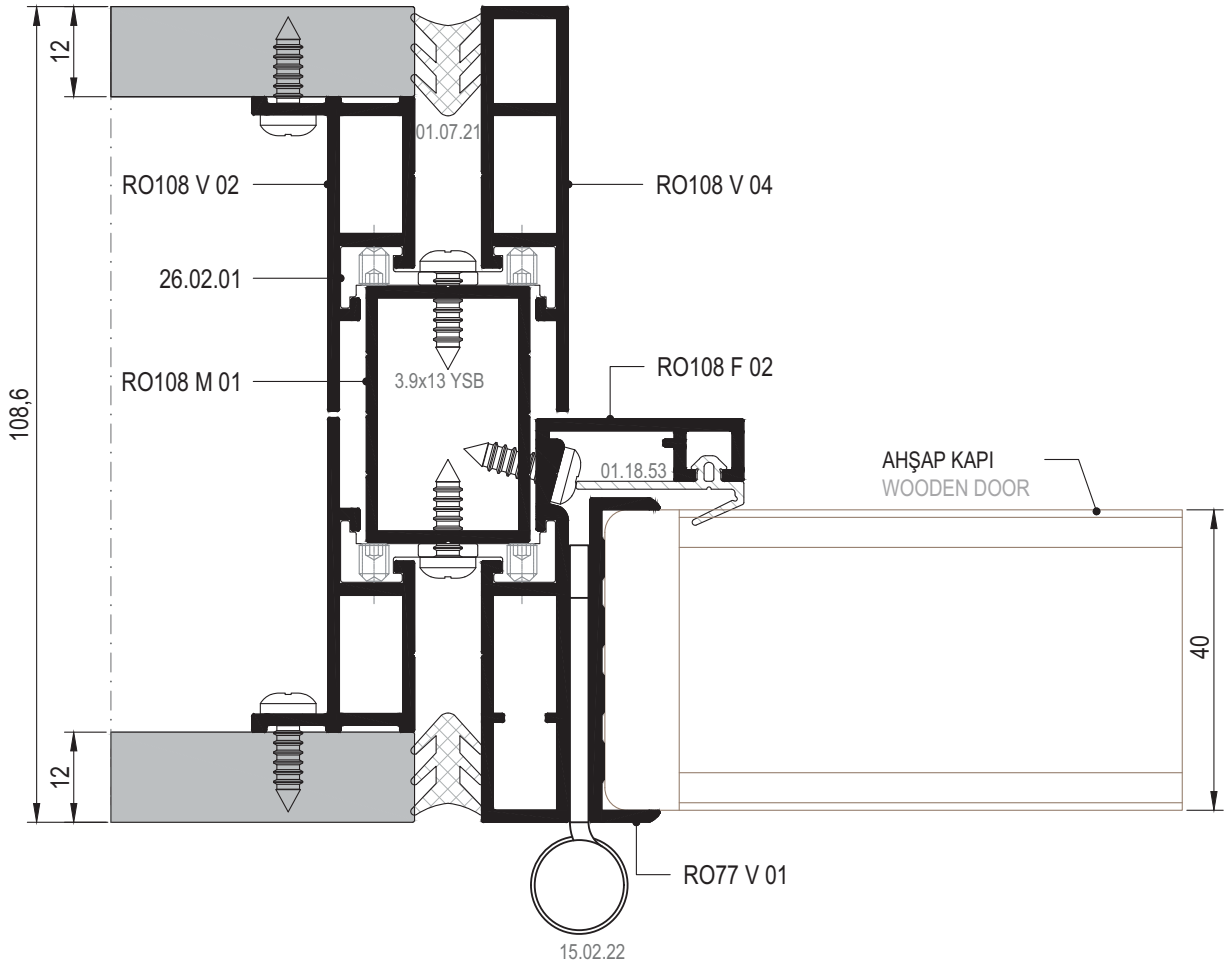

① DETAYI  
DETAIL



ALÜMİNYUM KASA AHŞAP KAPI DETAYI  
WOOD DOOR WITH ALUMINIUM FRAME DETAIL

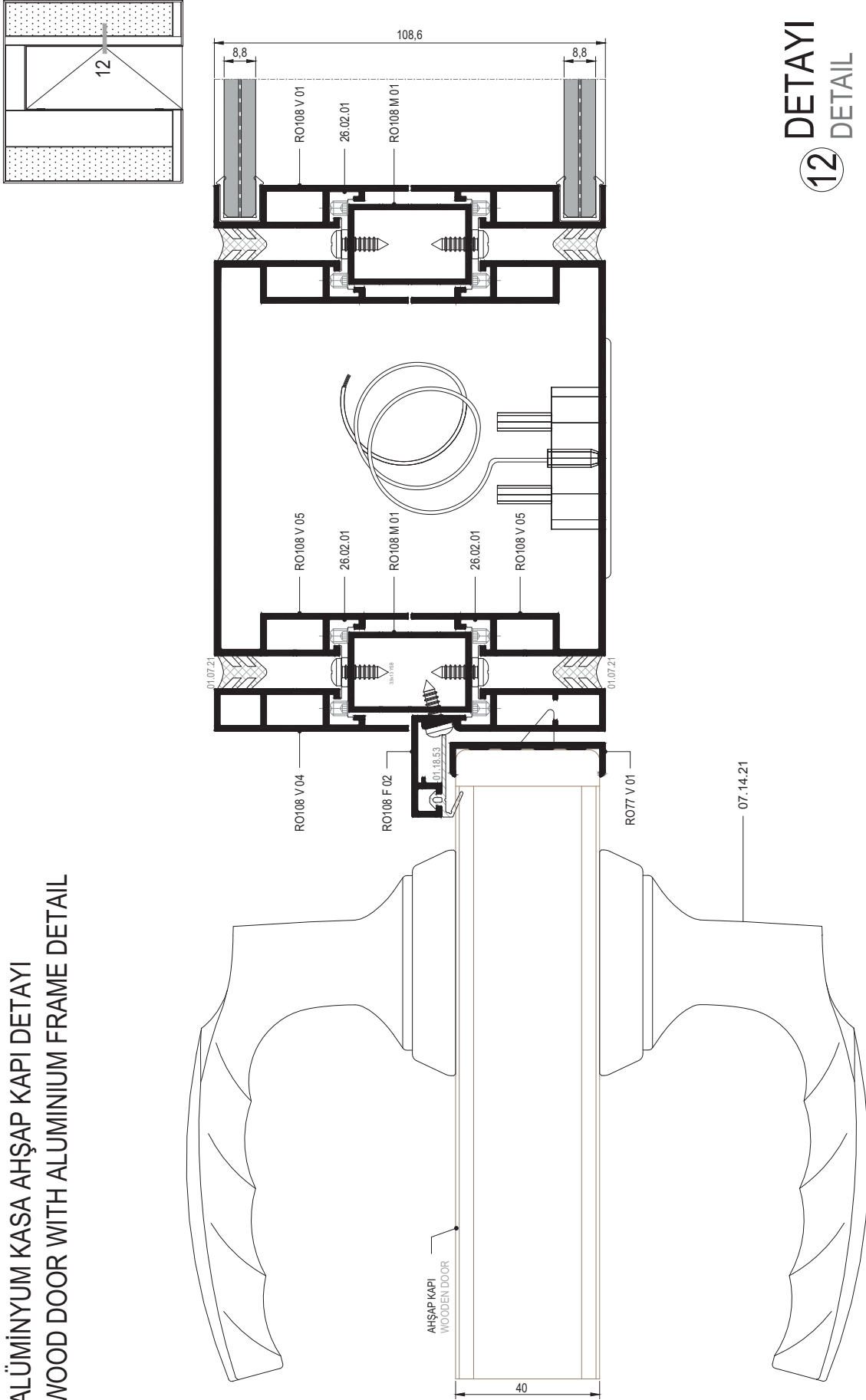

DETAYI  
DETAIL  
12

- 01
- 02
- 03
- 04
- 05
- 06
- 07
- 08
- 09
- 10
- 11
- 12
- 13

01

02

ALÜMİNYUM KASA AHŞAP KAPI DETAYI  
WOOD DOOR WITH ALUMINIUM FRAME DETAIL

03

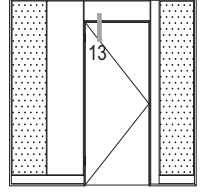

04

05

06

07

08

09

10

11

12

13

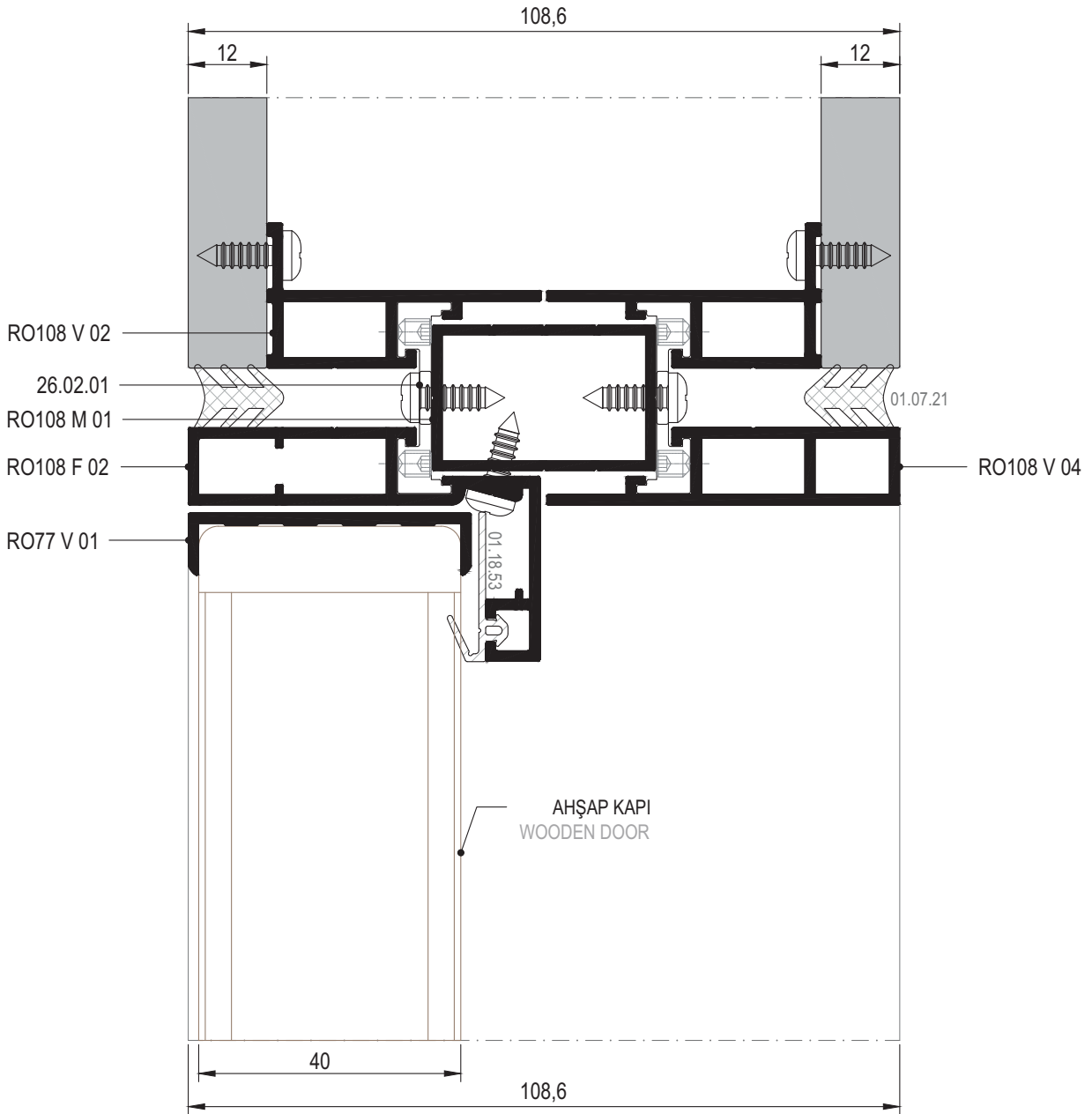

13 DETAYI  
DETAIL

01

02

03

04

05

06

07

08

09

10

11

12

13

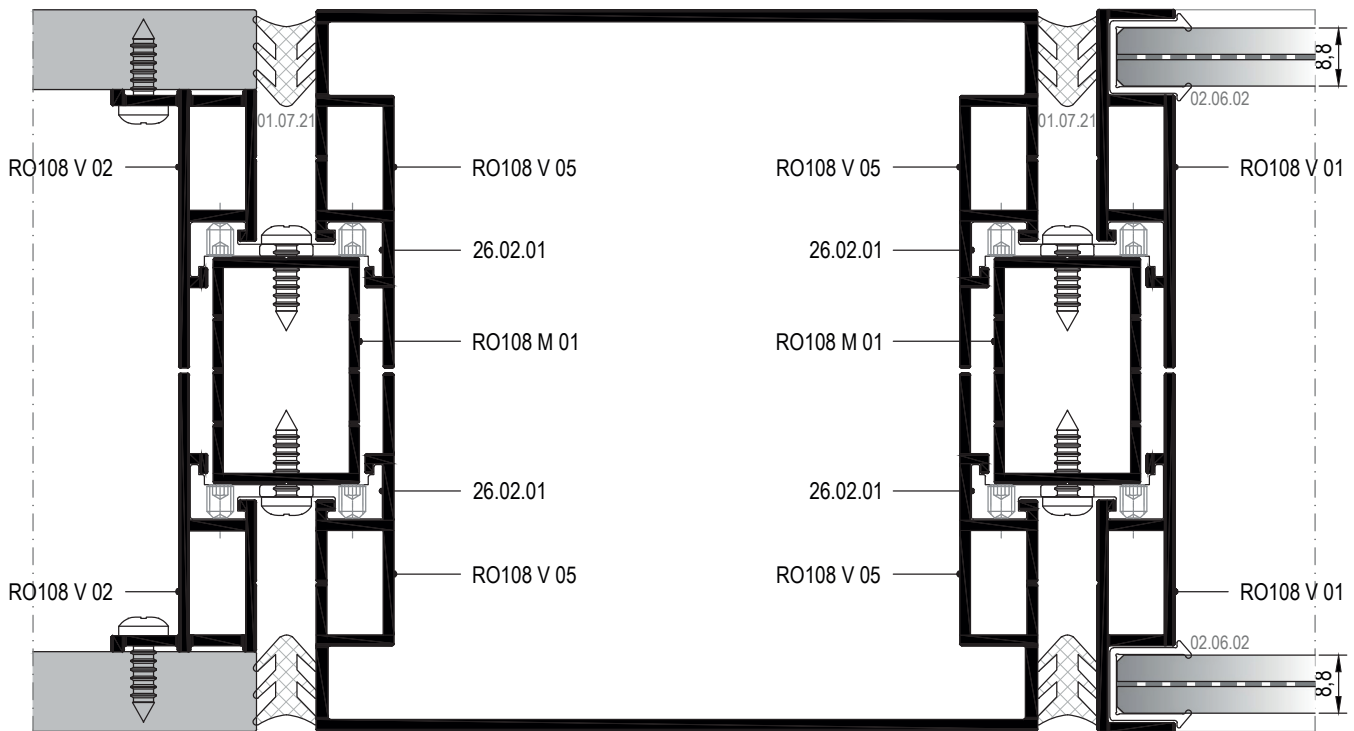
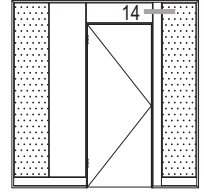

14 DETAYI  
DETAIL

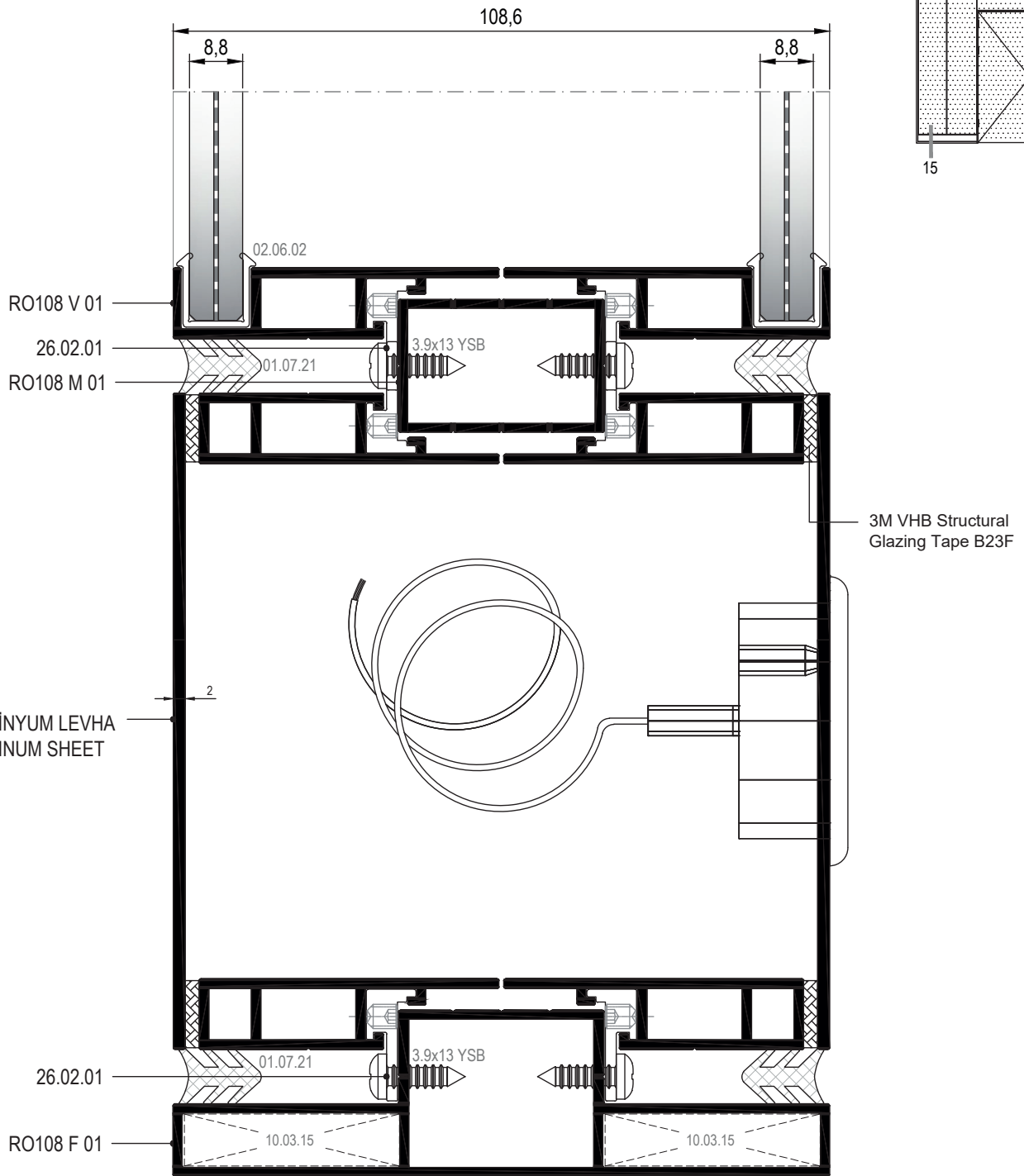

3M VHB Structural Glazing Tape B23F

15 DETAYI  
DETAIL

ALÜMİNYUM KASA ALÜMİNYUM ÇERÇEVELİ CAM KAPI DETAYI  
GLASS DOOR WITH ALUMINIUM FRAME DETAIL

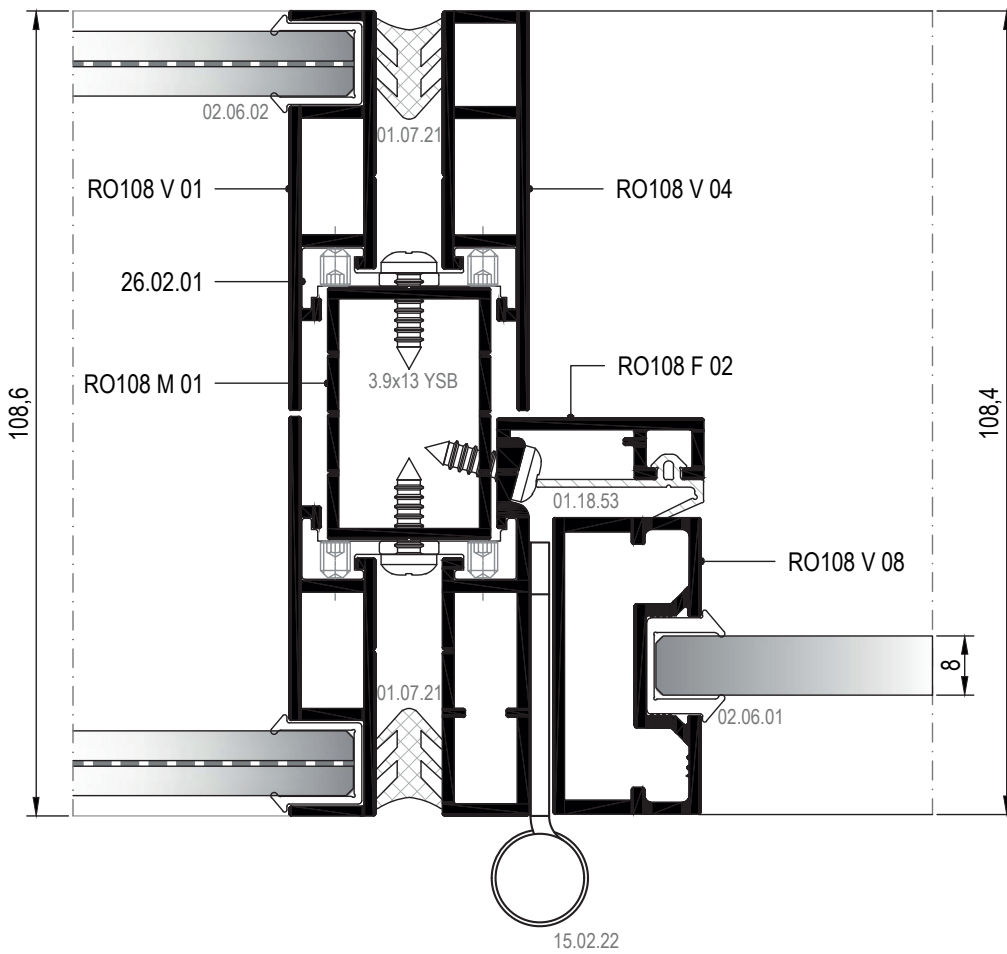
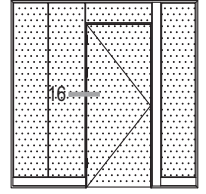

16 DETAYI  
DETAIL

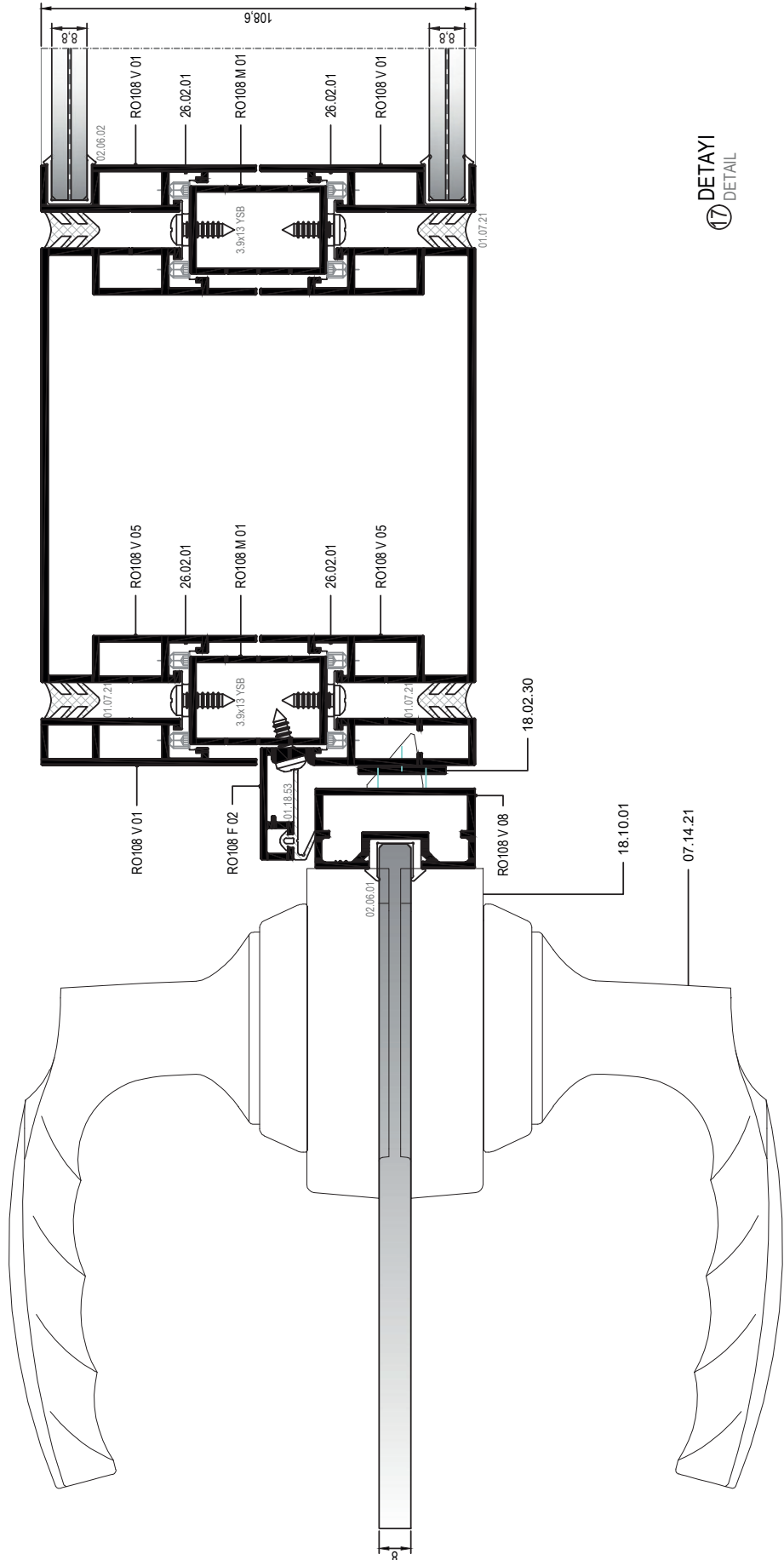
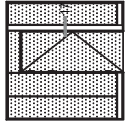

DETAYI  
DETAIL

ALÜMİNYUM KASA ALÜMİNYUM ÇERÇEVELİ CAM KAPI DETAYI  
GLASS DOOR WITH ALUMINIUM FRAME DETAIL

ALÜMİNYUM KASA ALÜMİNYUM ÇERÇEVELİ CAM KAPI DETAYI  
GLASS DOOR WITH ALUMINIUM FRAME DETAIL

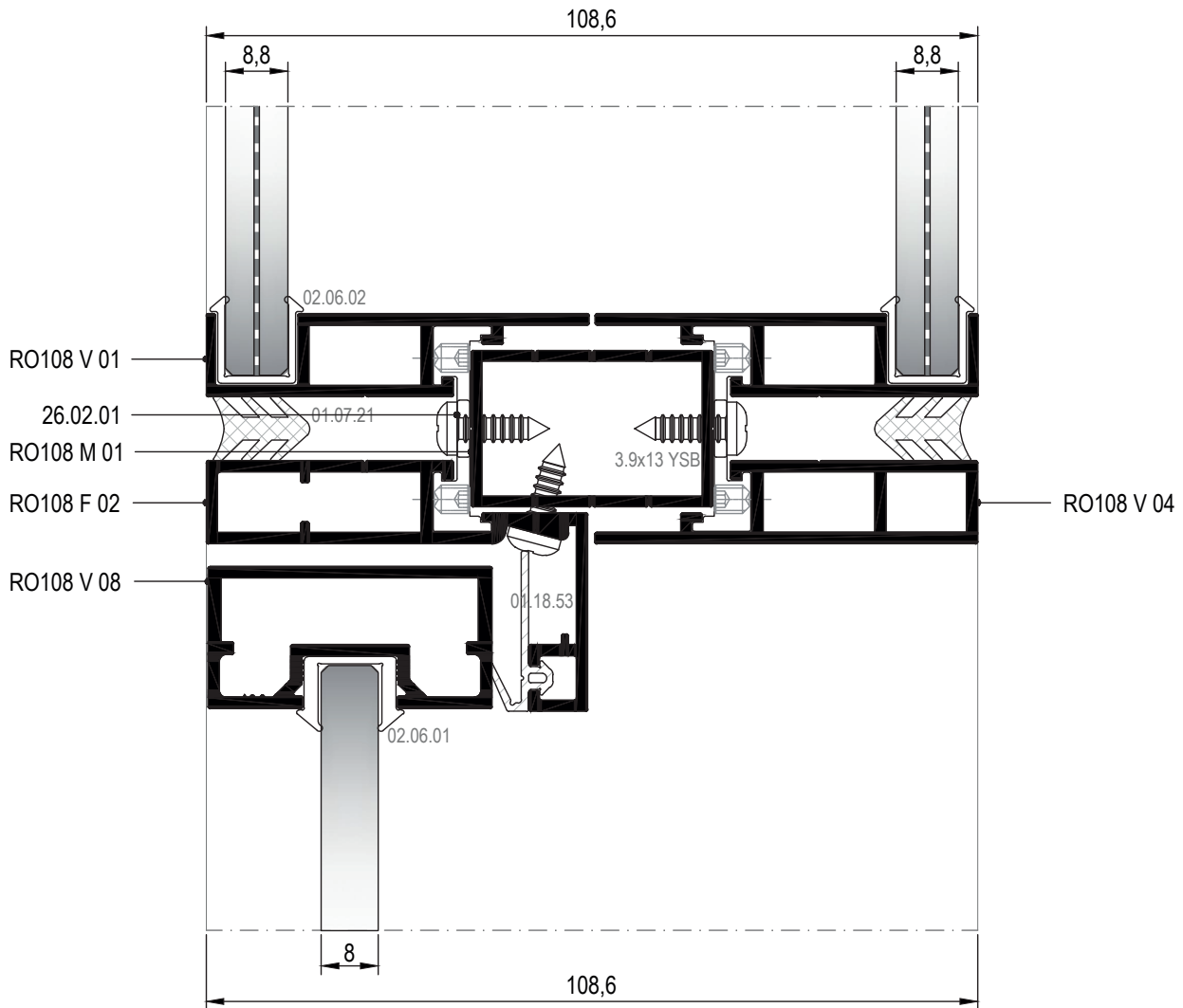
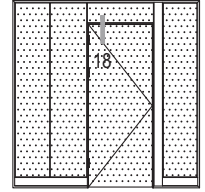

18 DETAYI  
DETAIL

01

02

03

04

05

06

07

08

09

10

11

12

13

01

02

ALÜMİNYUM KASA CAM KAPI DETAYI  
GLASS DOOR WITH ALUMINIUM FRAME DETAIL

03

04

05

06

07

08

09

10

11

12

13

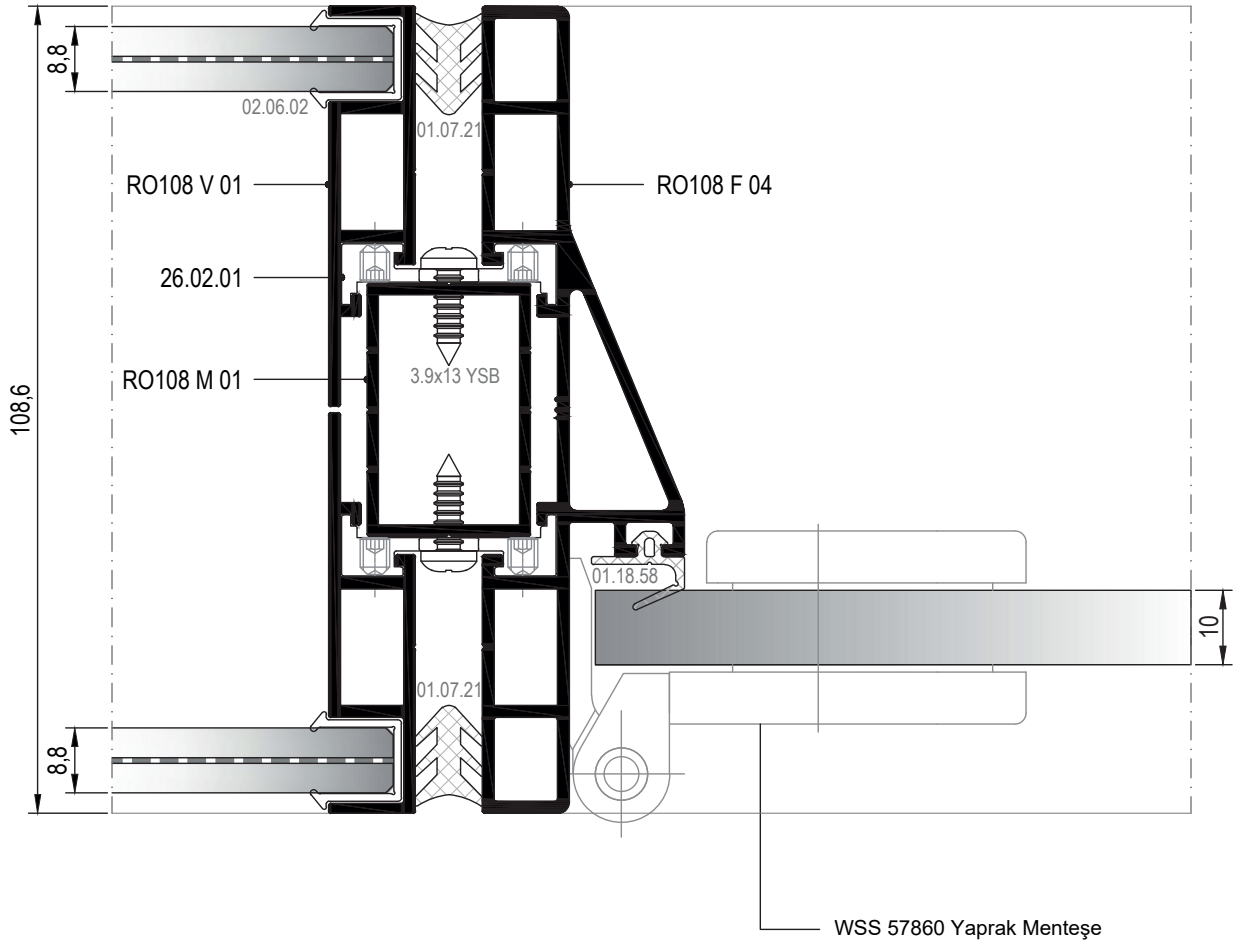
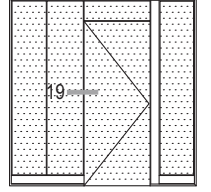

19 DETAYI  
DETAIL



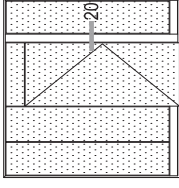

ALÜMİNYUM KASA CAM KAPI DETAYI  
GLASS DOOR WITH ALUMINIUM FRAME DETAIL

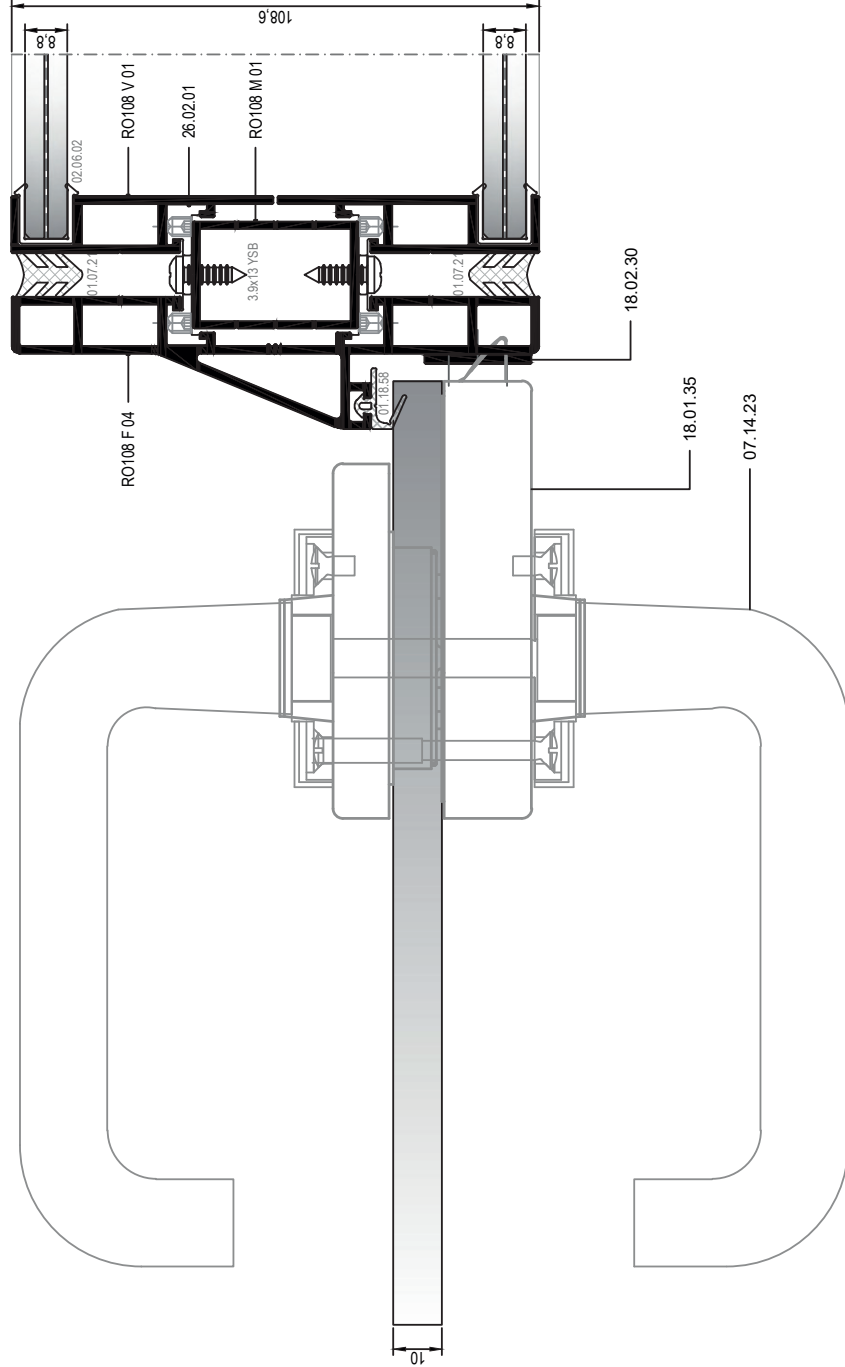

Ölçek/Scale: 1/2

20 DETAYI  
DETAIL

- 01
- 02
- 03
- 04
- 05
- 06
- 07
- 08
- 09
- 10
- 11
- 12
- 13

01

02

ALÜMİNYUM KASA CAM KAPI DETAYI  
GLASS DOOR WITH ALUMINIUM FRAME DETAIL

03

04

05

06

07

08

09

10

11

12

13

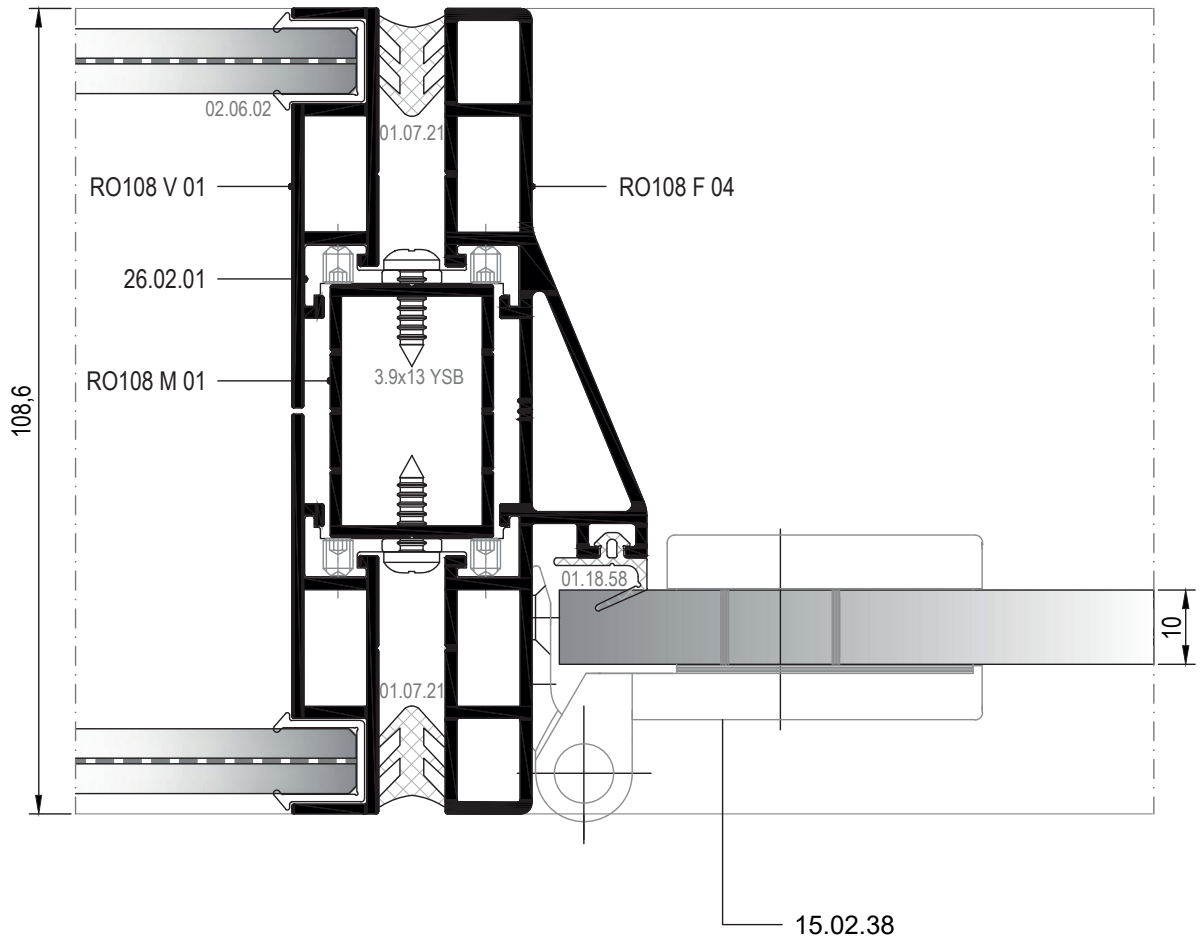
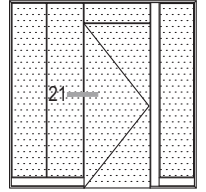

21 DETAYI  
DETAIL

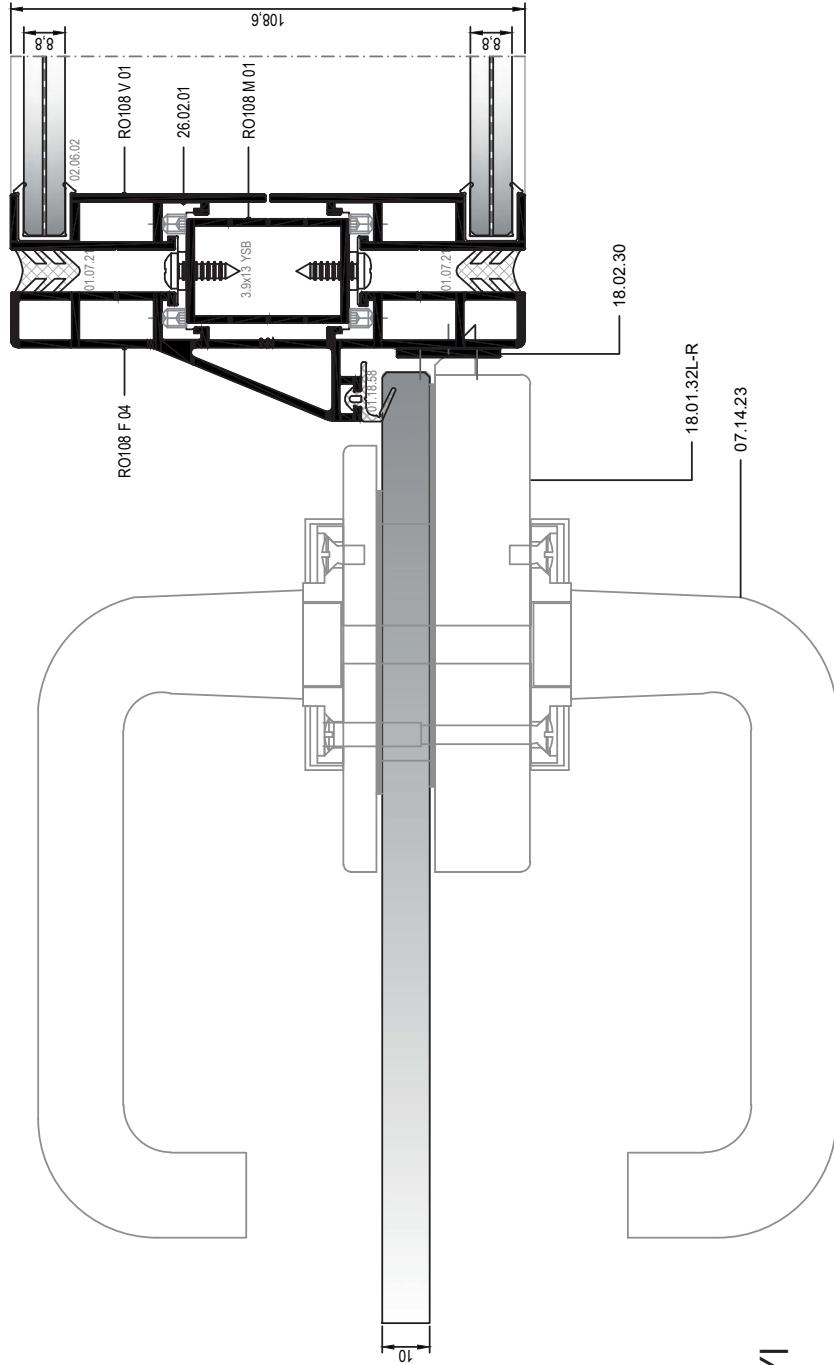
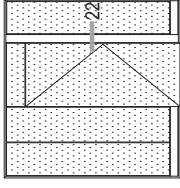

ALÜMİNYUM KASA CAM KAPI DETAYI  
GLASS DOOR WITH ALUMINIUM FRAME DETAIL

DETAYI  
DETAIL  
22

01

02

03

04

05

06

07

08

09

10

11

12

13

23

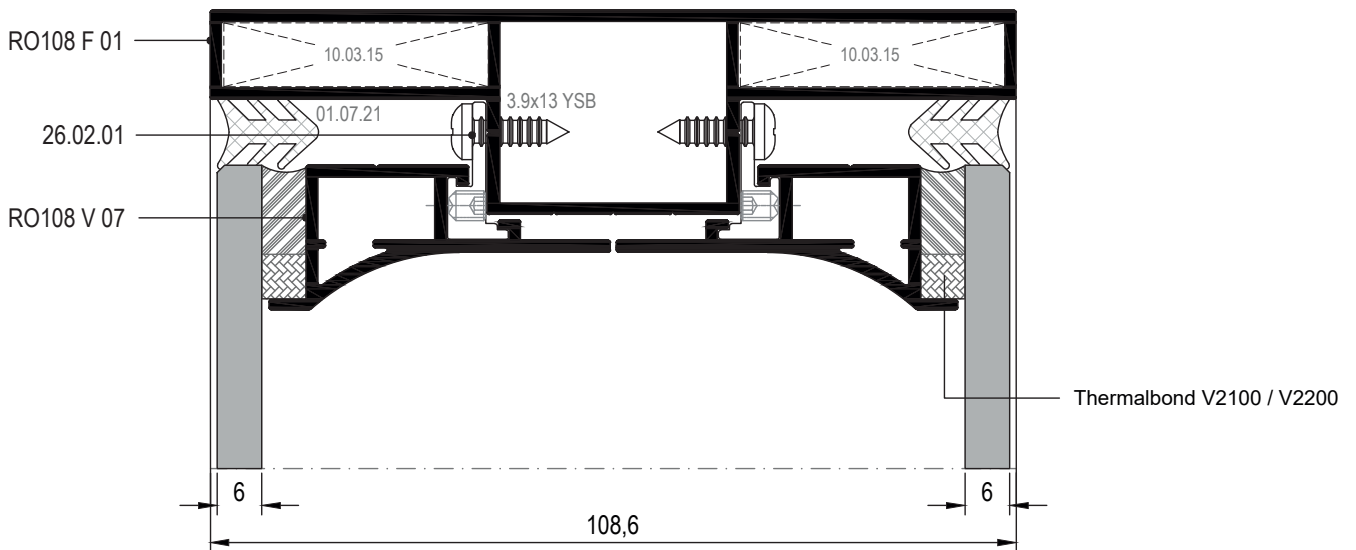
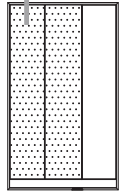

23 DETAYI  
DETAIL

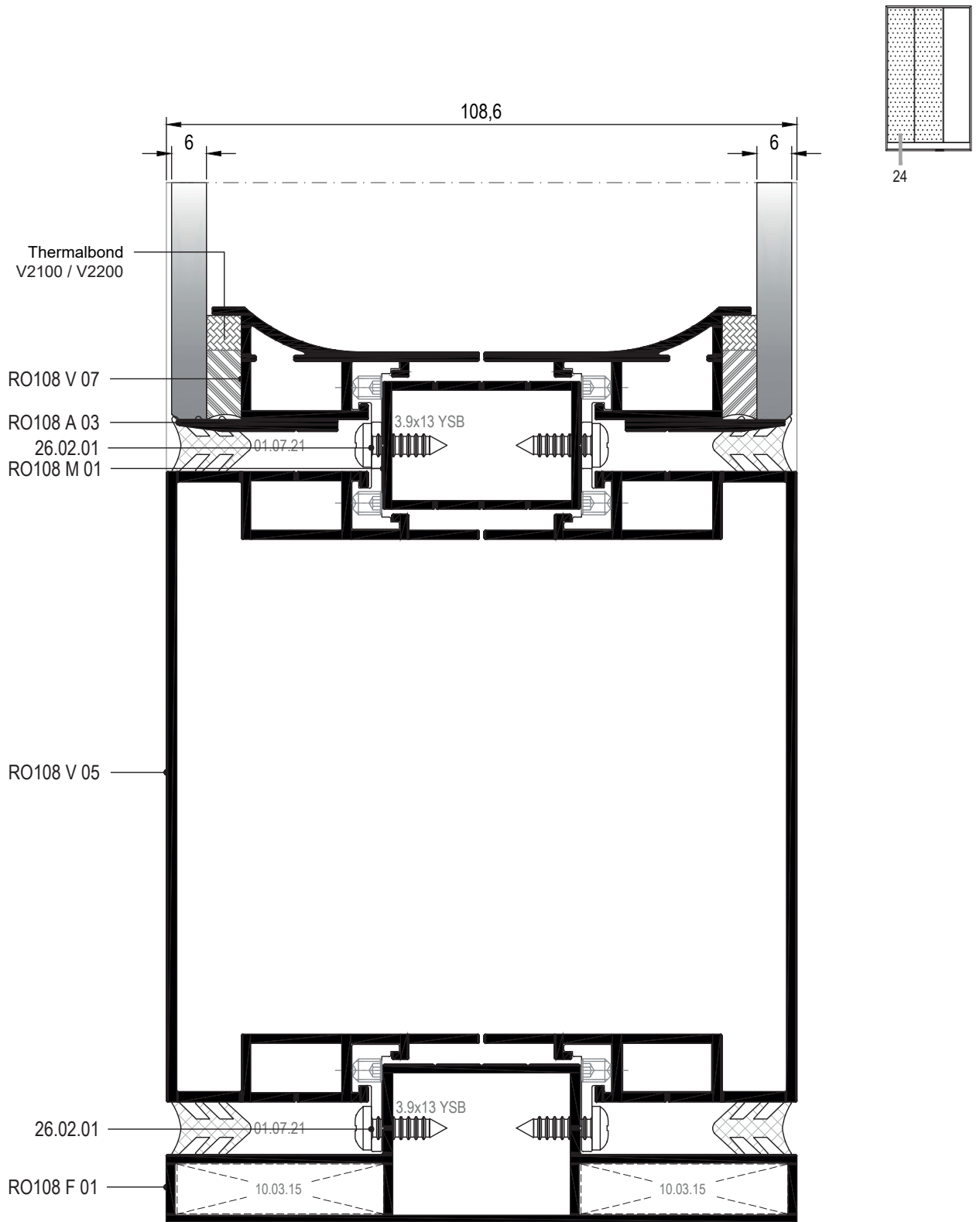

24 DETAYI  
DETAIL

01

02

03

04

05

06

07

08

09

10

11

12

13

01

02

03

04

05

06

07

08

09

10

11

12

13

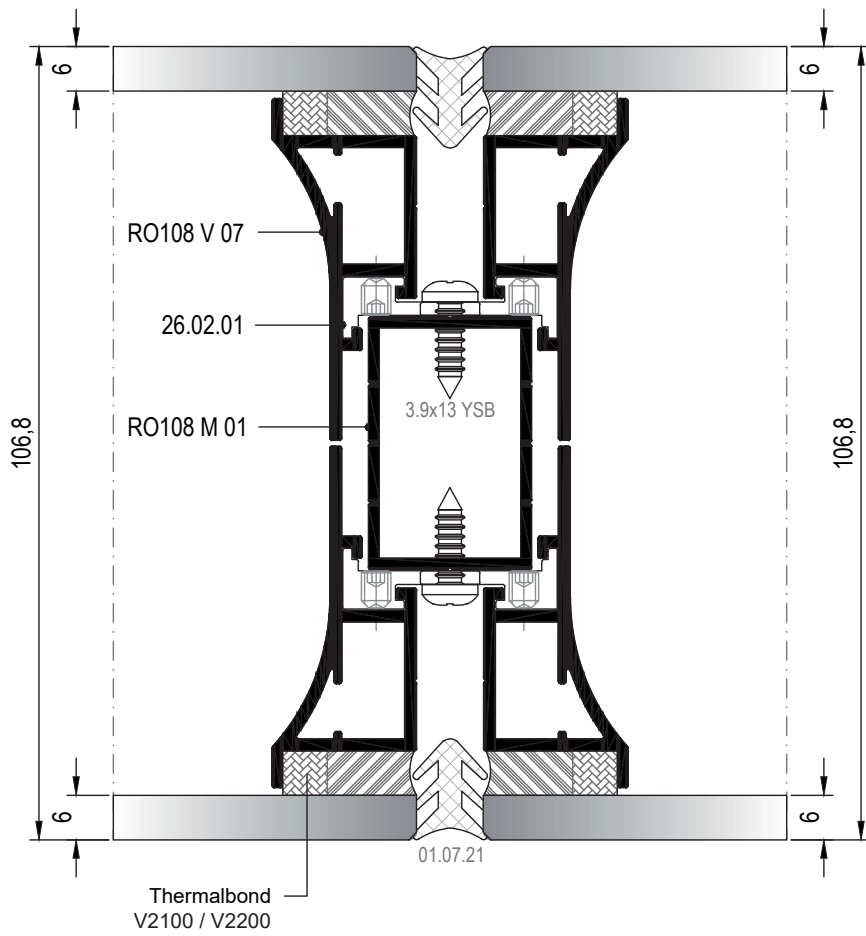
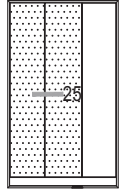

25 DETAYI  
DETAIL

01

02

03

04

05

06

07

08

09

10

11

12

13

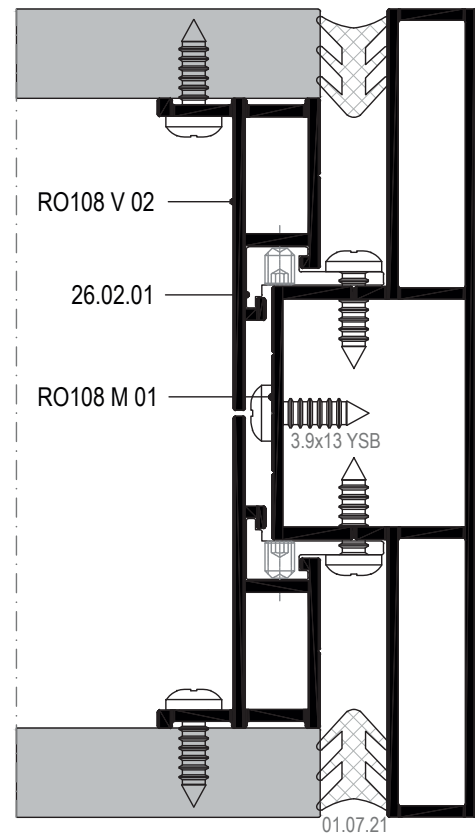
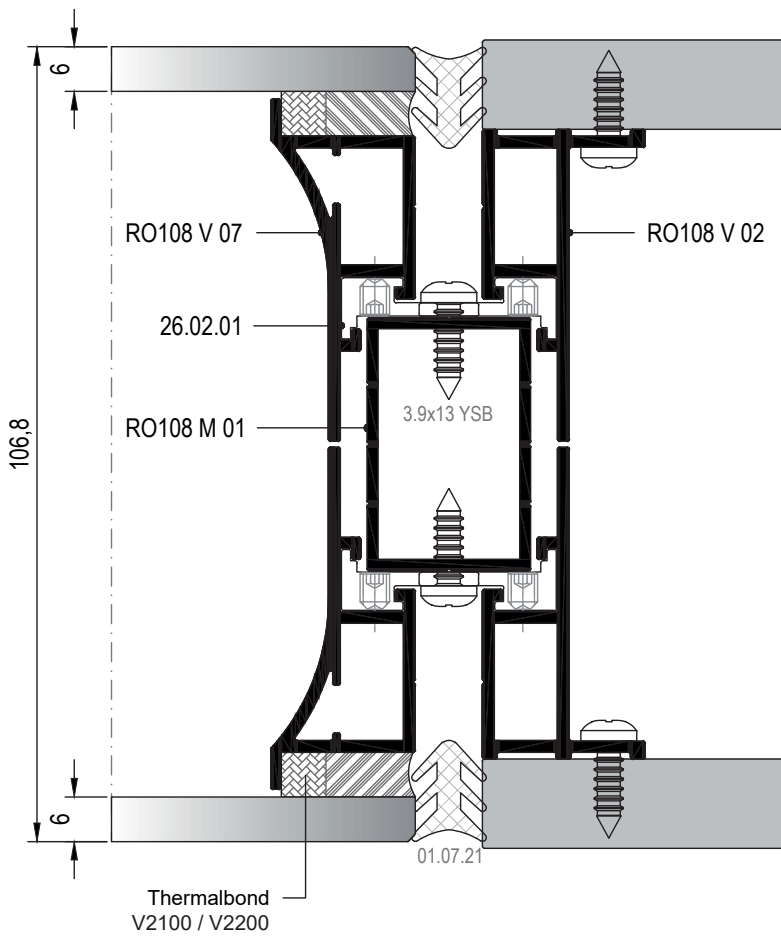
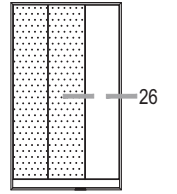

26 DETAYI  
DETAIL

01

02

03

04

05

06

07

08

09

10

11

12

13

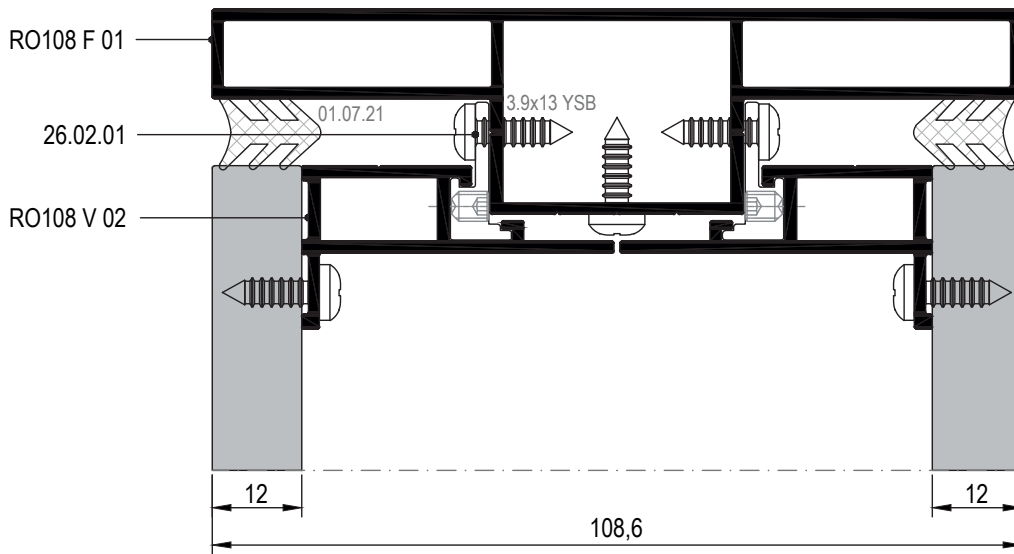
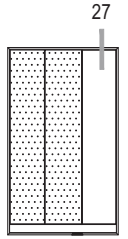

27 DETAYI  
DETAIL



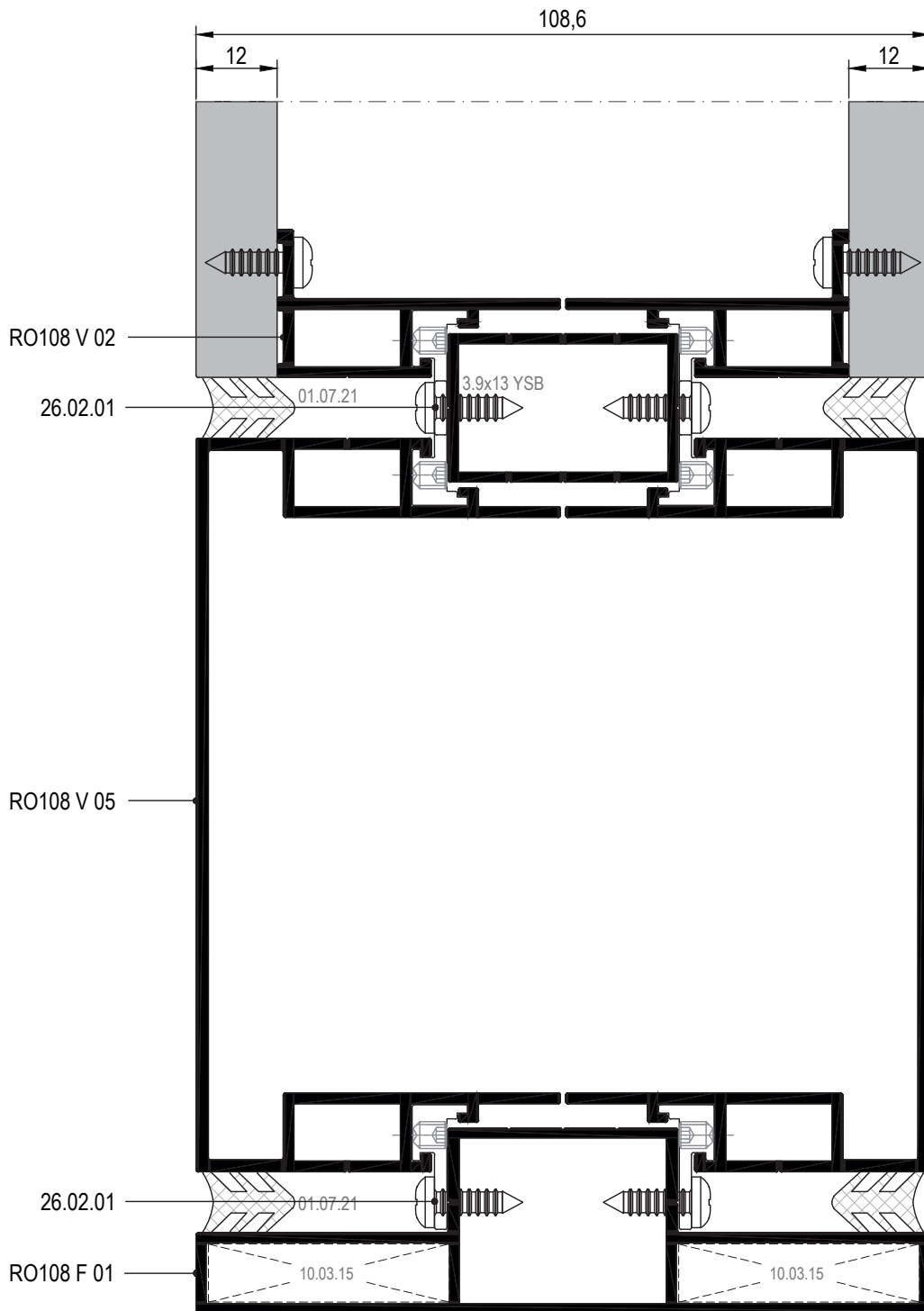

28 DETAYI  
DETAIL

01

02

03

04

05

06

07

08

09

10

11

12

13

01

02

03

04

05

06

07

08

09

10

11

12

13

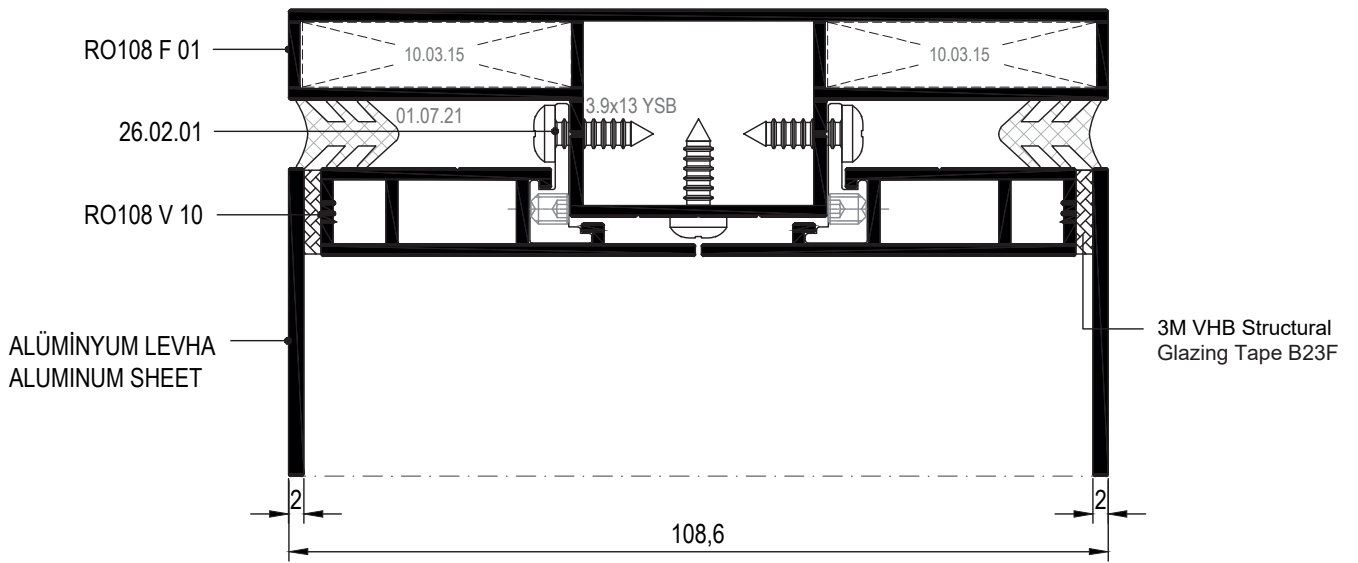
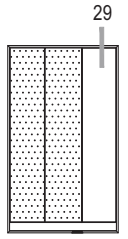

29 DETAYI  
DETAIL

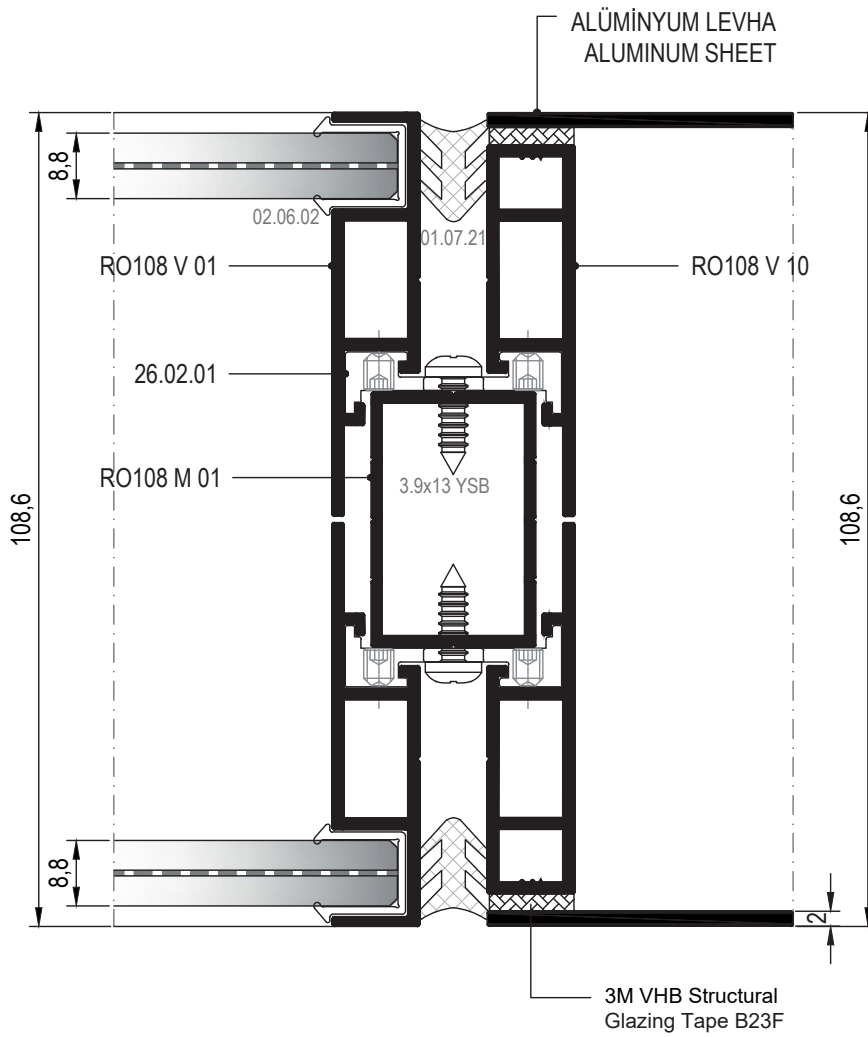
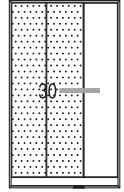

01

02

03

04

05

06

07

08

09

10

11

12

13

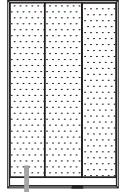

31

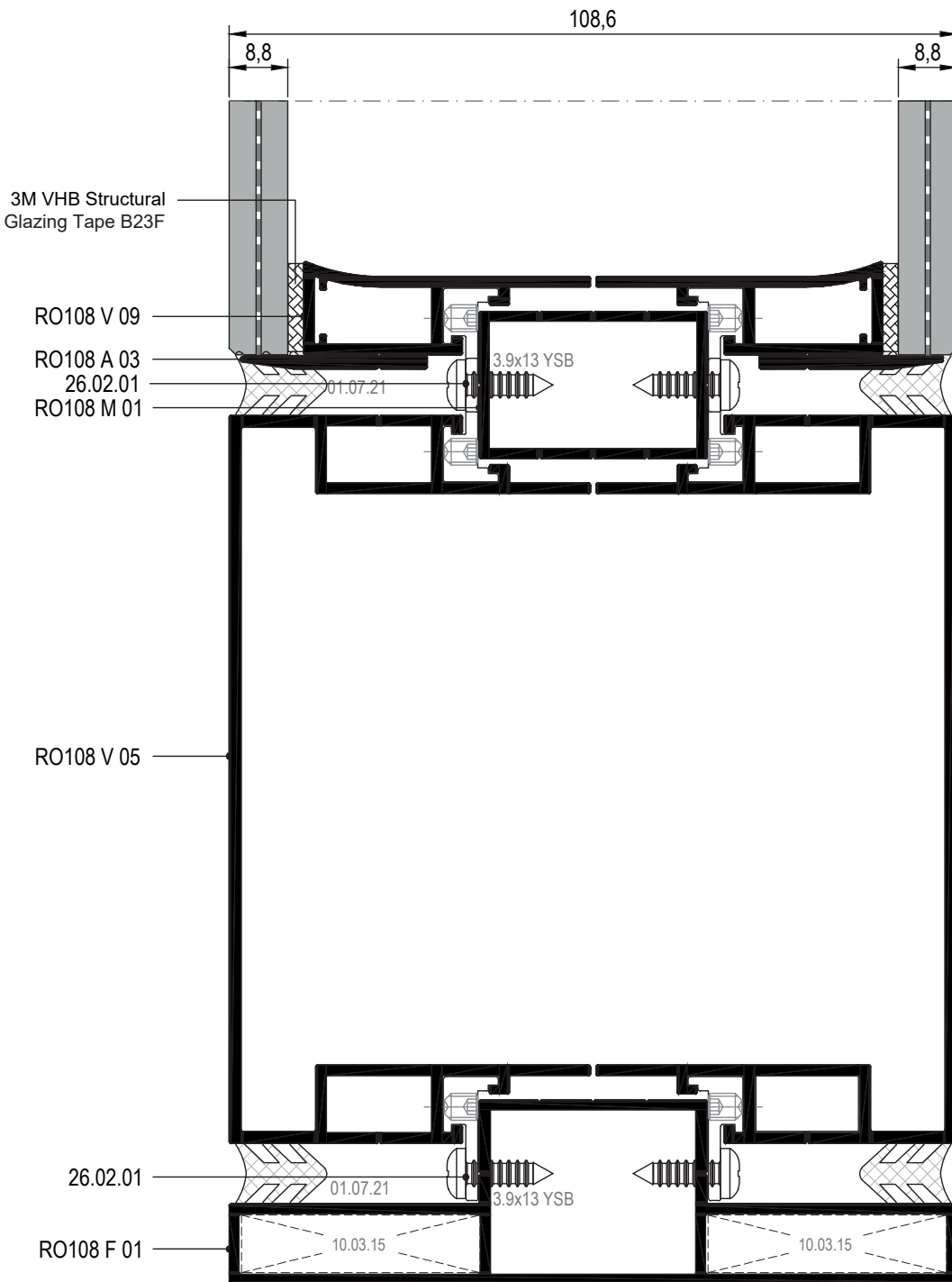

31 DETAYI  
DETAIL

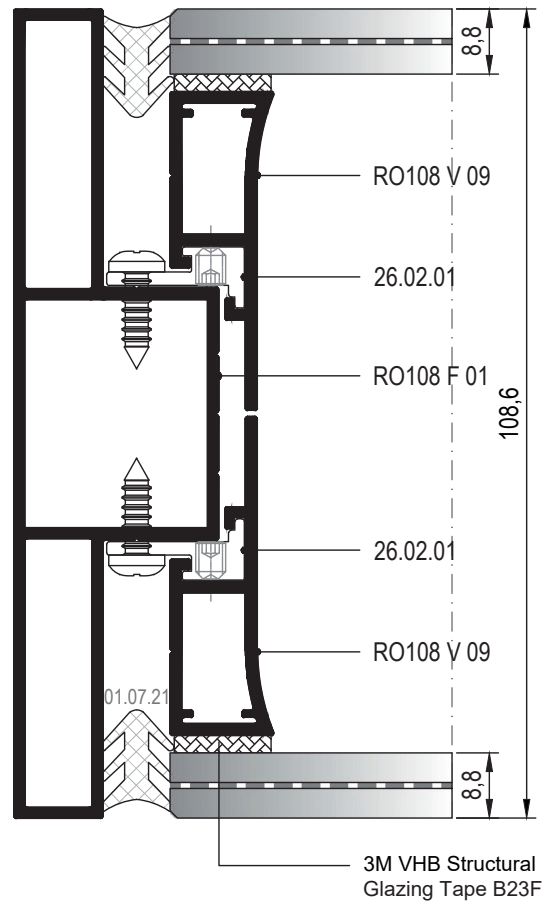
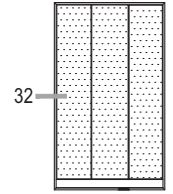

01

02

03

04

05

06

07

08

09

10

11

12

13

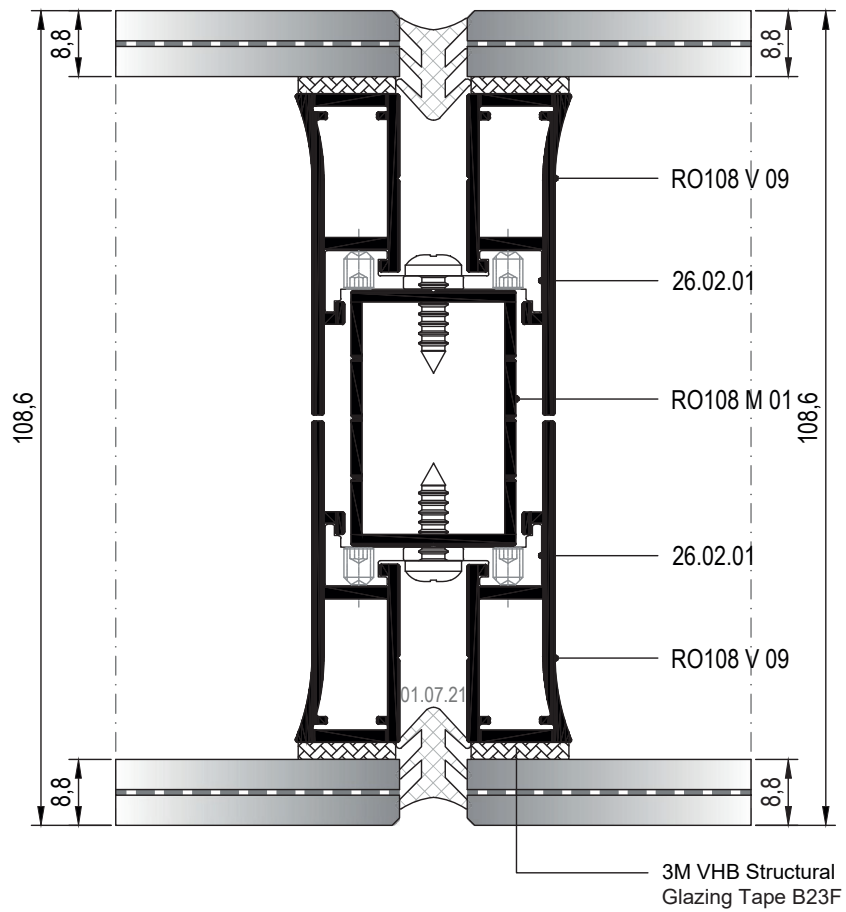
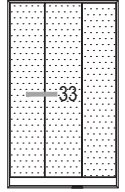

33 DETAYI  
DETAIL

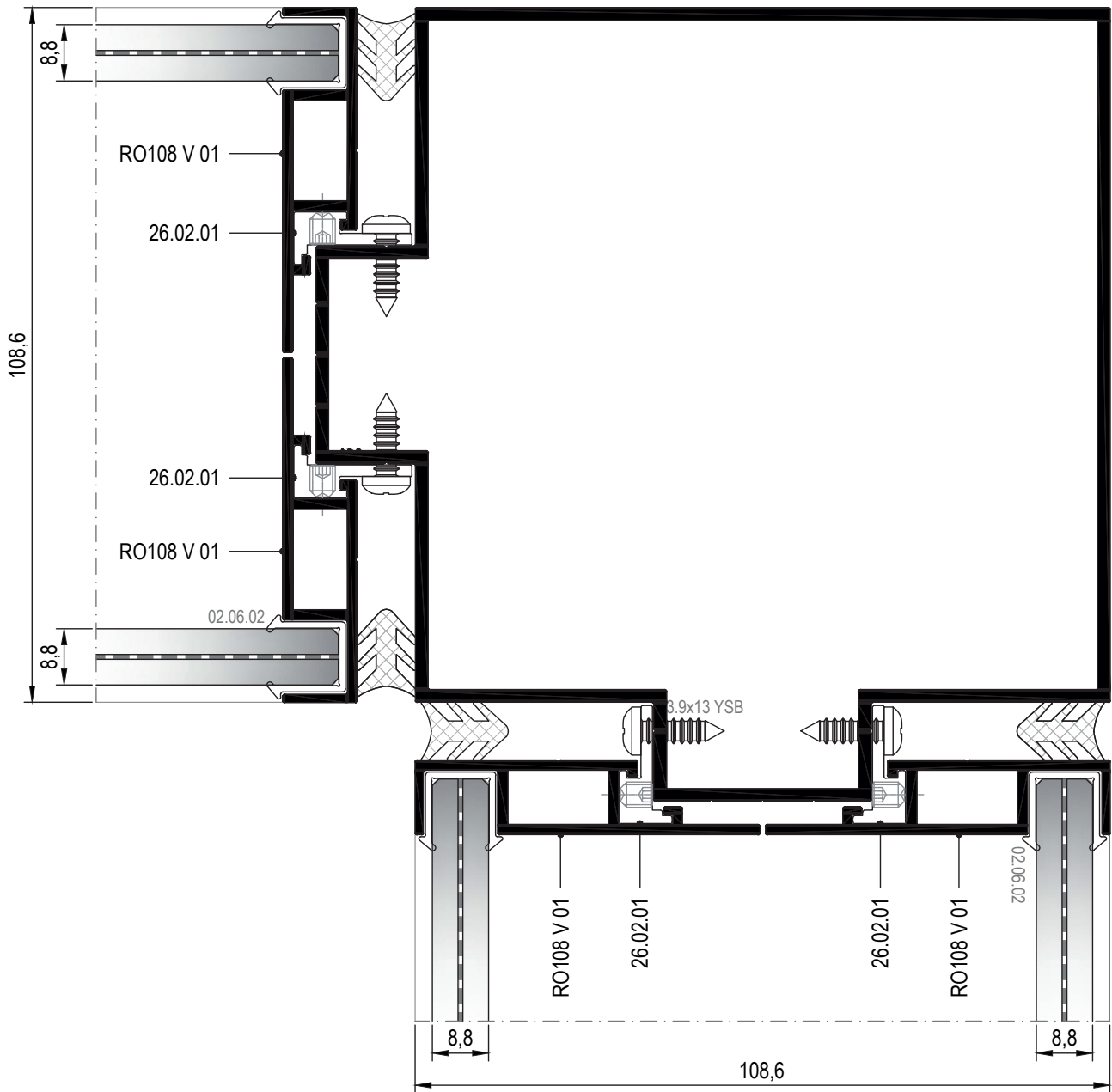

34 DETAYI  
DETAIL

01

02

03

04

05

06

07

08

09

10

11

12

13

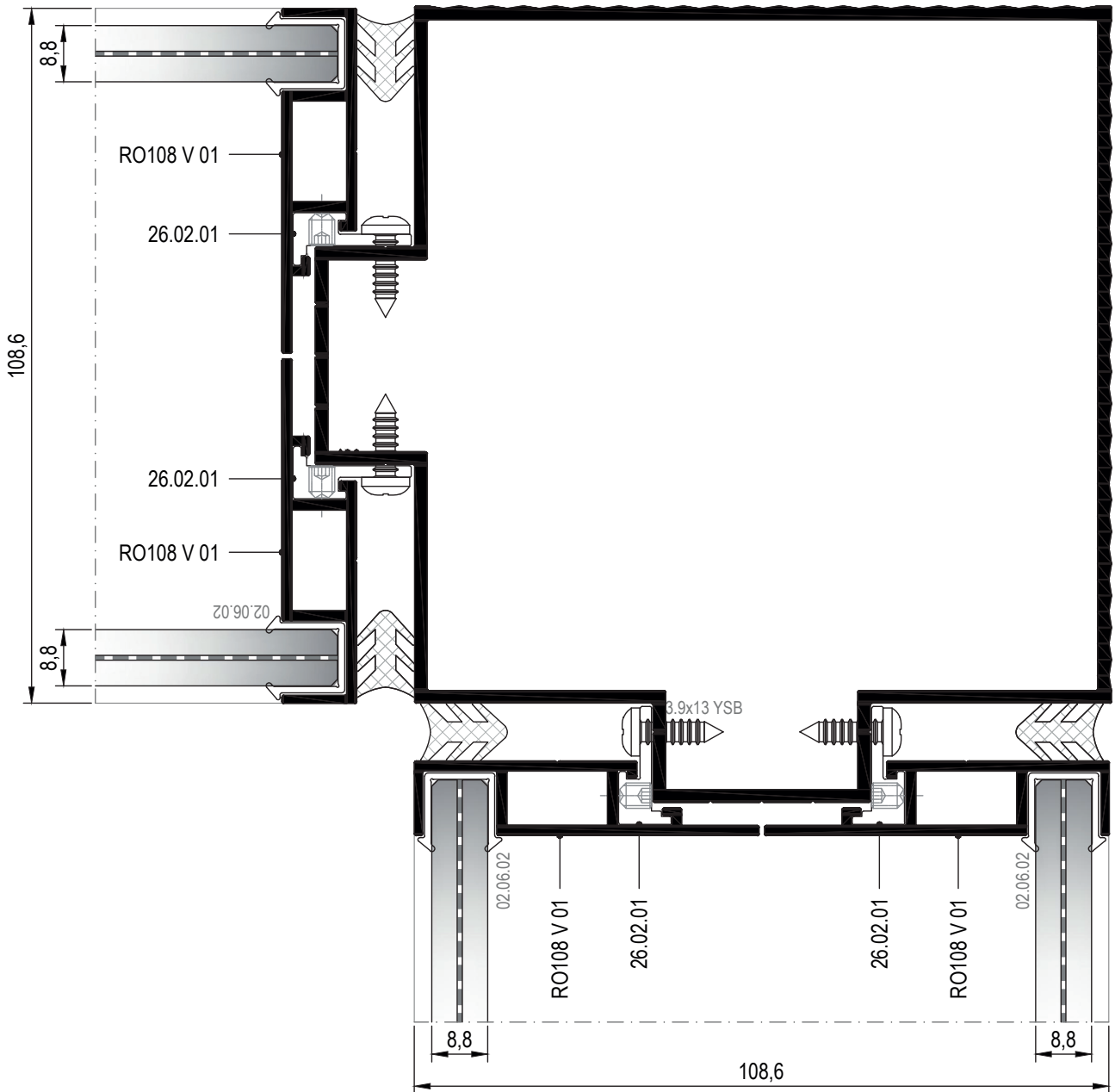

35 DETAYI  
DETAIL





01

02

03

04

05

06

07

08

09

10

11

12

13

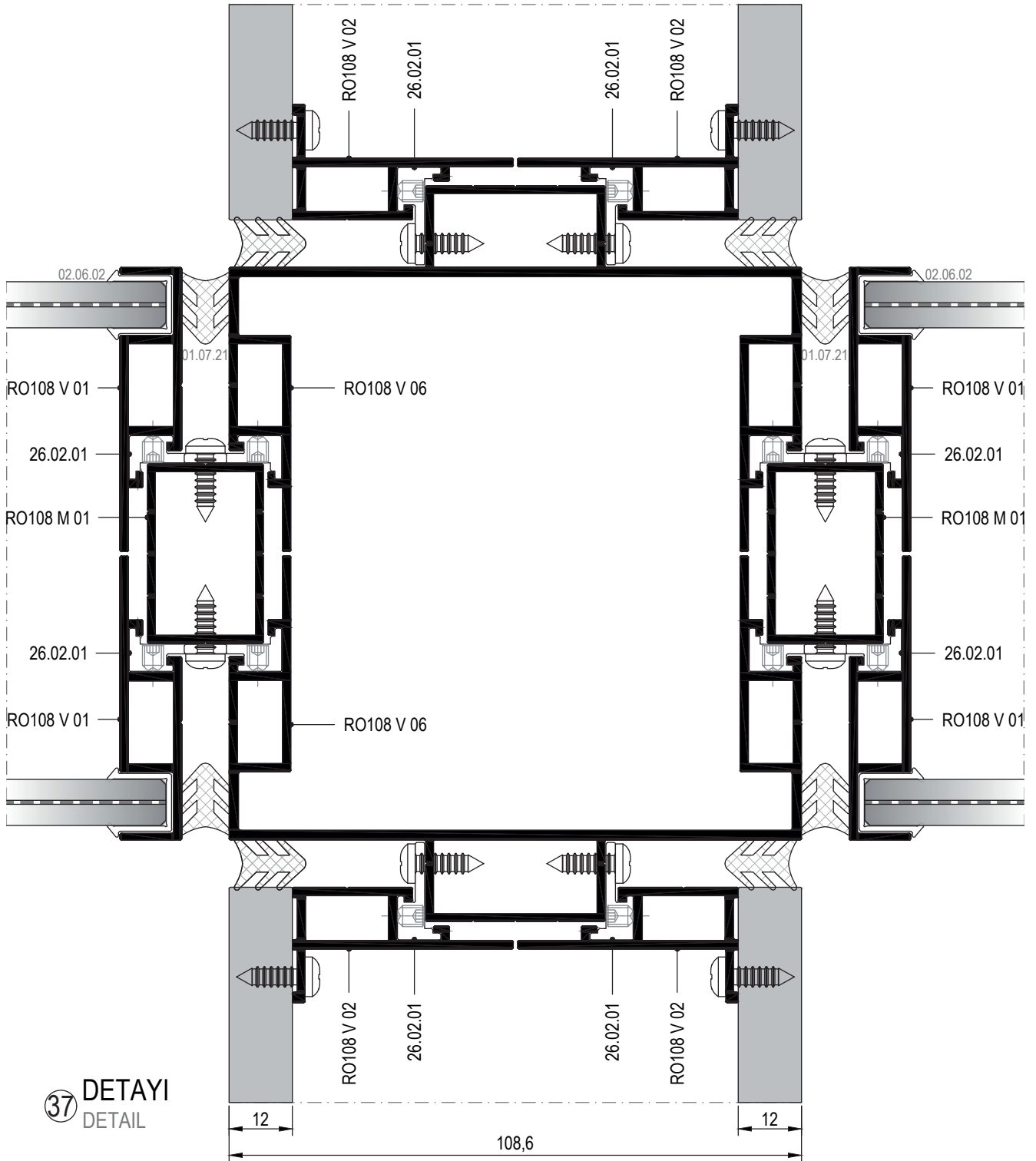

01

02

03

04

05

06

07

08

09

10

11

12

13

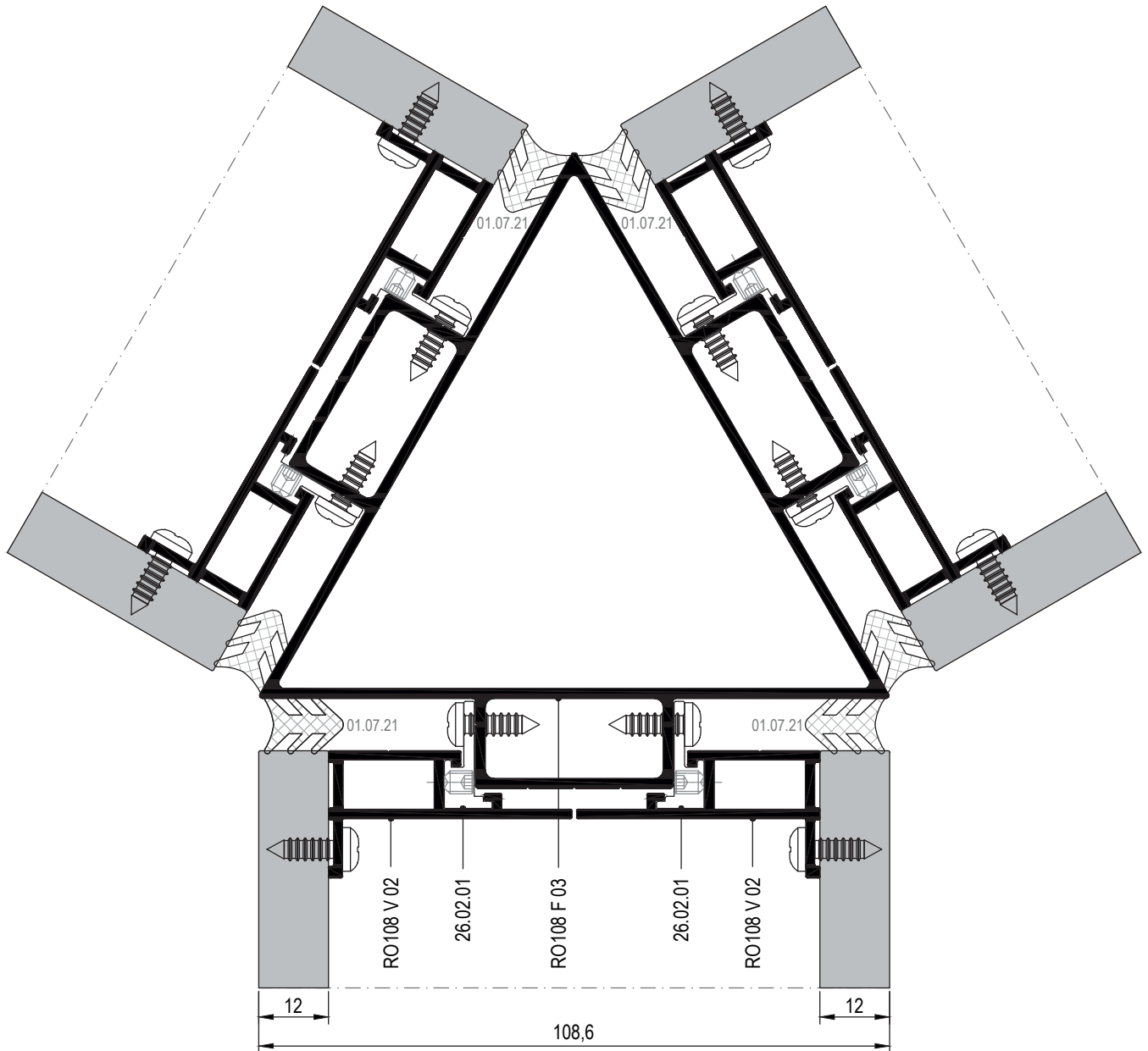

38 DETAYI  
DETAIL

01

02

03

04

05

06

07

08

09

10

11

12

13

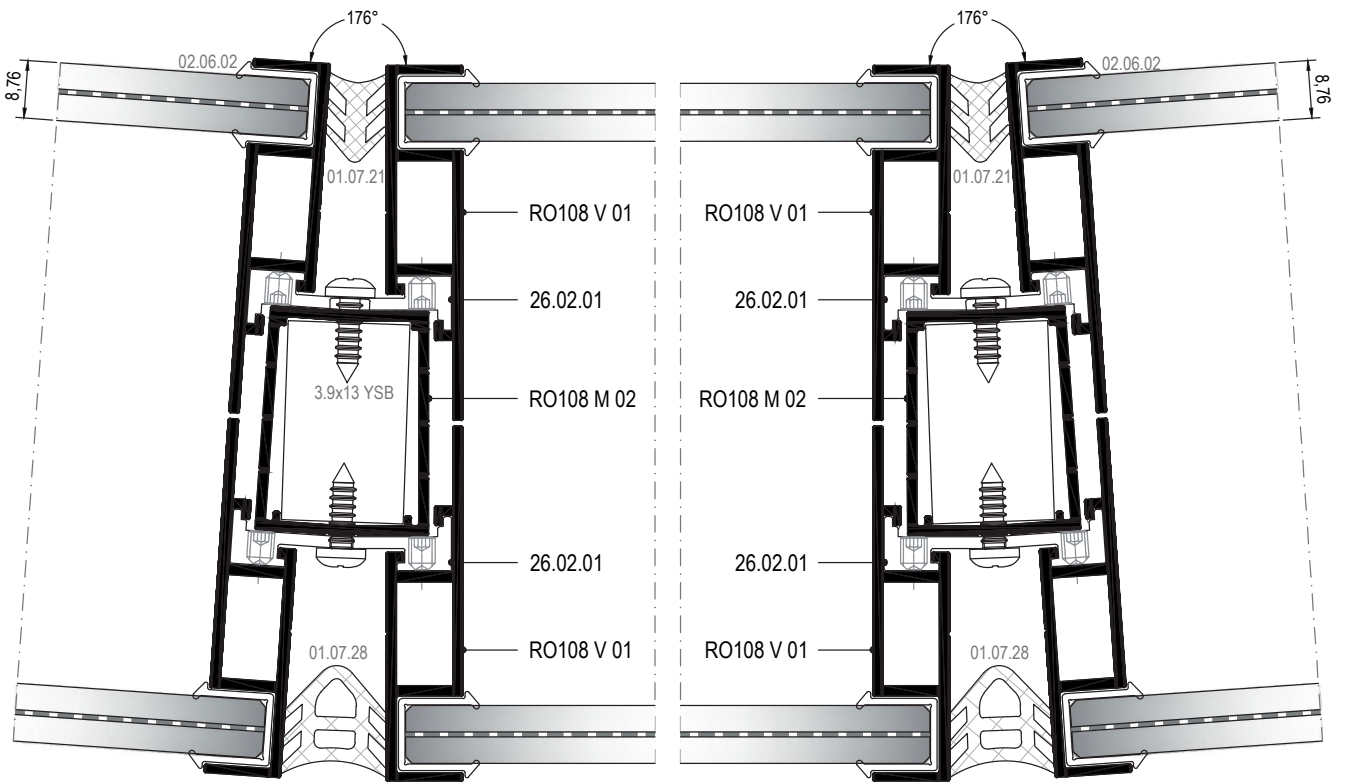

39 DETAYI  
DETAIL

# MİMARİ KATALOG ARCHITECTURAL CATALOGUE

Alüminyum Kapı Pencere ve Giydirme Cephe Sistemleri  
Aluminium Window Doors and Facade Systems

# RO108

AKSESUARLAR

ACCESSORIES

01

02

03

04

05

06

07

08







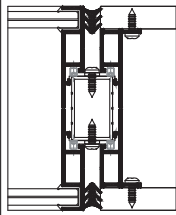

09

10

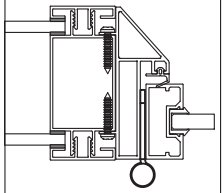
11

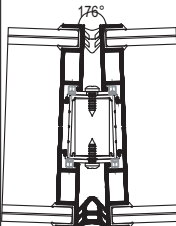
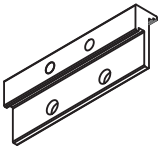
12

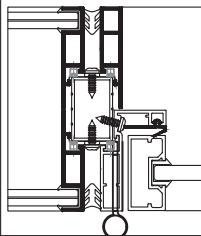
13

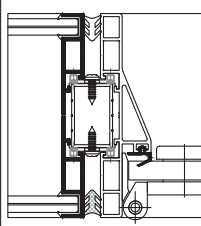
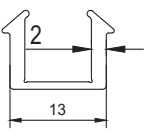
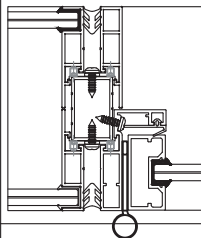
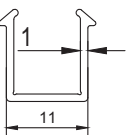
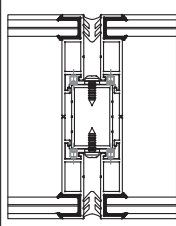
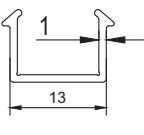
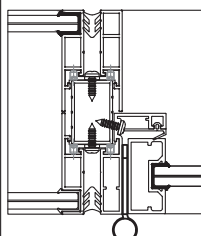
01					
02		<b>01.07.21</b> DERZ FİTİLİ LAP JOINT GASKET Malzeme / Material : EPDM Ağırlık / Weight : 125 gr/m Paket / Package: 120 m / 15 kg			<b>15.02.22</b> KAPI MENTEŞESİ HINGE FOR DOOR 
03					
04		<b>01.07.28</b> DERZ FİTİLİ LAP JOINT GASKET Malzeme / Material : EPDM Ağırlık / Weight : X gr/m Paket / Package: X m / X kg			<b>26.02.01</b> KİLİTLEME PROFİLİ LOCKING PROFILE Malzeme / Material : ALÜMİNYUM+SETSKUR+VIDA
05					
06		<b>01.18.53</b> İÇ BİNİ FİTİLİ XXXXX Malzeme / Material : EPDM Ağırlık / Weight : X gr/m Paket / Package: X m / X kg			<b>26.02.02</b> BAĞLANTI PROFİLİ CONNECTION PROFILE Malzeme / Material : ALÜMİNYUM
07					
08		<b>01.18.58</b> DIŞ BİNİ FİTİLİ XXX Malzeme / Material : EPDM Ağırlık / Weight : X gr/m Paket / Package: X m / X kg			
09		<b>02.06.01</b> CAM U FİTİLİ 8 - 8.76mm U GASKET Malzeme / Material : ŞEFFAF PVC			
10					
11		<b>02.06.02</b> CAM U FİTİLİ 8 - 8.76mm U GASKET Malzeme / Material : ŞEFFAF PVC			
12					
13		<b>02.06.03</b> CAM U FİTİLİ 10 - 10.76mm U GASKET Malzeme / Material : ŞEFFAF PVC			

ALÜMİNYUM KASA AHŞAP KAPI DETAYI İÇİN  
WOOD DOOR WITH ALUMINIUM FRAME DETAIL

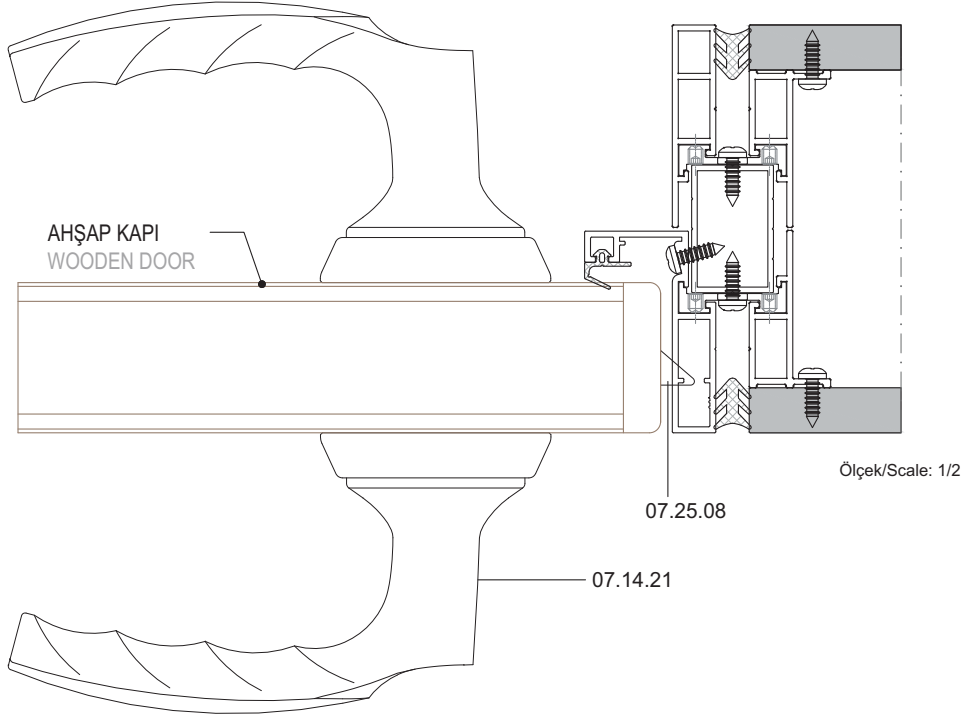

KOL ALTERNATİFLERİ / HANDLE ALTERNATIVES

	<p><b>07.14.21</b> HOPPE ATLANTA KAPI KOLU HOPPE ATLANTA DOOR HANDLE</p> <p>Renk / Colour : Siyah-Gri Black-Grey</p>	
---	--	--

DİL SETLERİ / MORTISE LOCKING SET

	<p><b>07.25.08</b> HOPPE HCS DİL SETİ HOPPE MORTISE LOCKING SET</p> <p>Renk / Colour : Paslanmaz çelik</p>	
---	--	--

ALÜMİNYUM KASA ALÜMİNYUM ÇERÇVELİ CAM KAPI DETAYI İÇİN  
GLASS DOOR WITH ALUMINIUM FRAME DETAIL

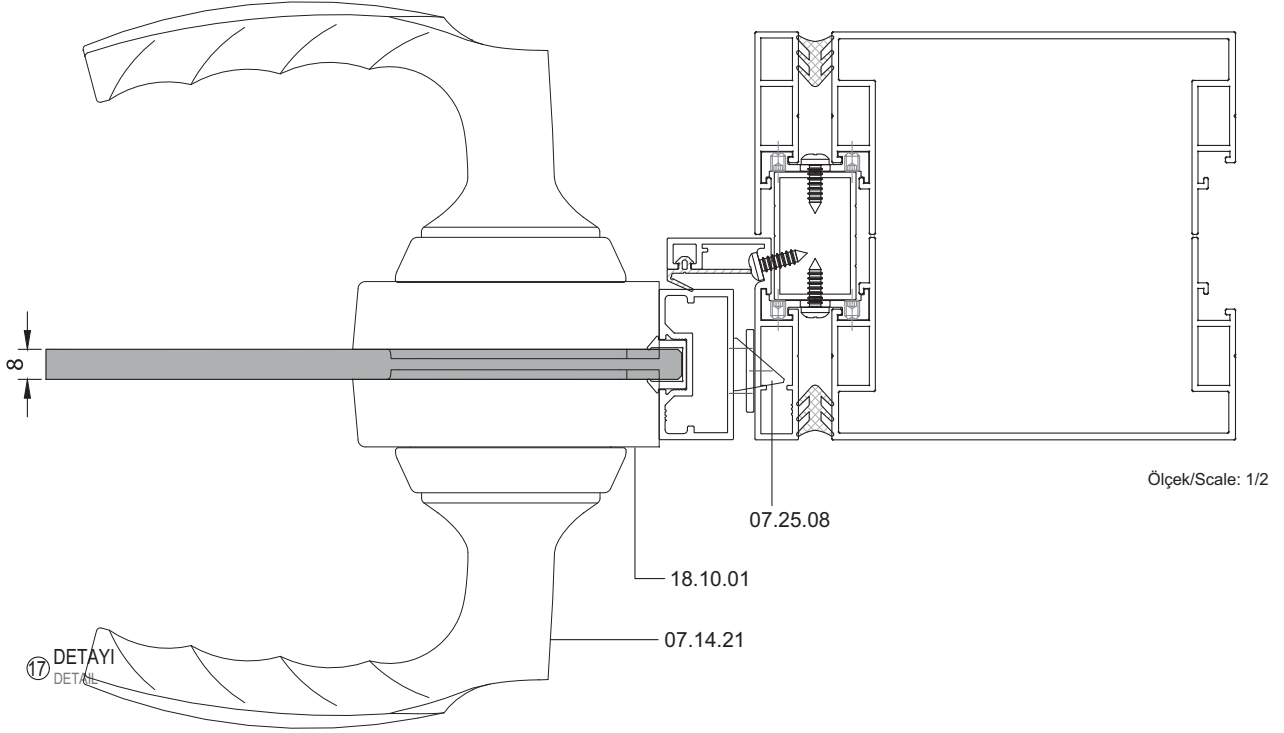

KOL ALTERNATİFLERİ / HANDLE ALTERNATIVES

 <p><b>07.14.21</b> HOPPE ATLANTA KAPI KOLU HOPPE ATLANTA DOOR HANDLE Renk / Colour : Siyah-Gri Black-Grey</p>	
---	--

DİL SETLERİ / MORTISE LOCKING SET

 <p><b>07.25.08</b> HOPPE HCS DİL SETİ HOPPE MORTISE LOCKING SET Renk / Colour : Paslanmaz çelik</p>	
---	--



ALÜMİNYUM KASA ALÜMİNYUM ÇERÇEVELİ CAM KAPI DETAYI İÇİN  
GLASS DOOR WITH ALUMINIUM FRAME DETAIL

CAM KAPI ADAPTÖRLERİ / ADAPTERS FOR GLASS DOOR

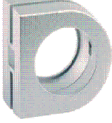
 <p><b>18.10.01</b> HOPPE CAM KAPI ADAPTÖRÜ HOPPE ADAPTER FOR GLASS DOOR</p>	
---	--

KASA KARŞILIKLARI / FRAME

 <p><b>18.02.30</b> HOPPE KASA KARŞILIĞI HOPPE STRIKER FOR FRAME</p>	
--	--

ALÜMİNYUM KASA CAM KAPI DETAYI İÇİN  
GLASS DOOR WITH ALUMINIUM FRAME DETAIL

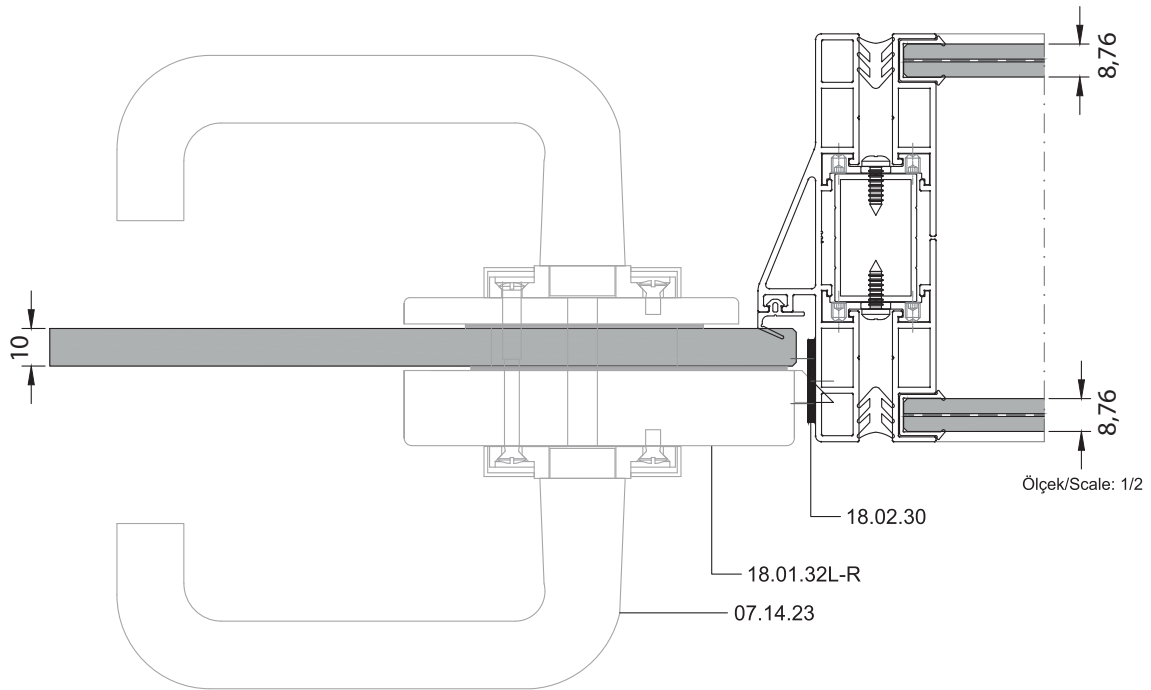
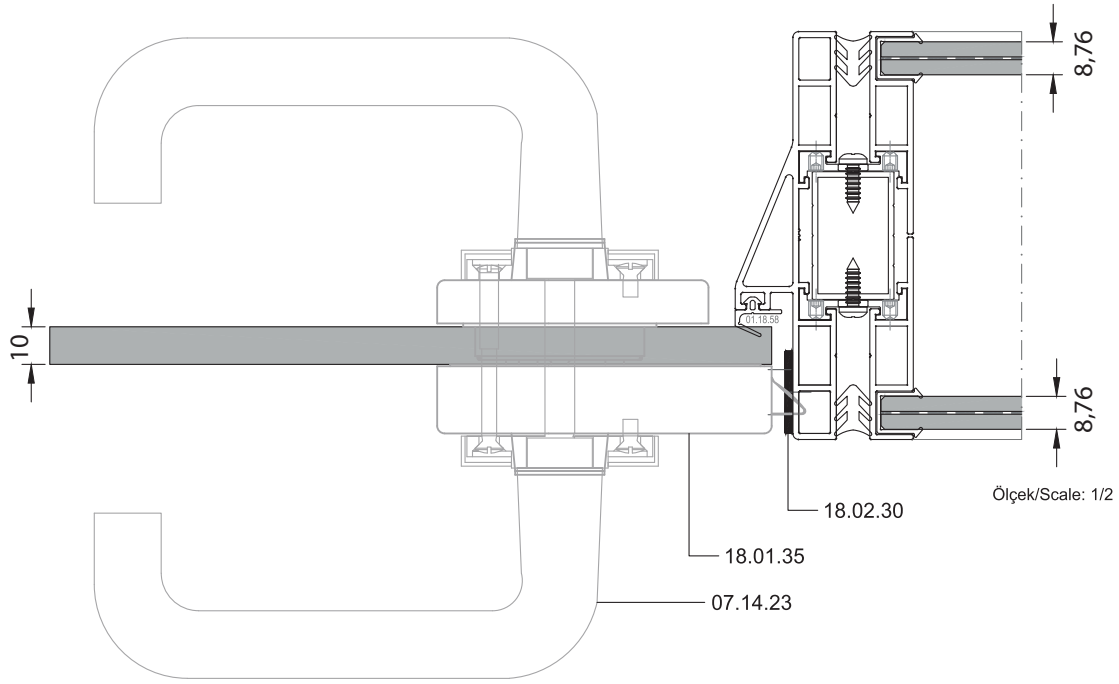

ALÜMİNYUM KASA CAM KAPI DETAYI İÇİN  
GLASS DOOR WITH ALUMINIUM FRAME DETAIL

KOL ALTERNATİFLERİ / HANDLE ALTERNATIVES

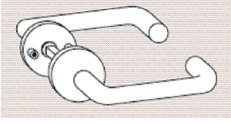
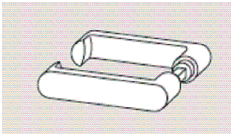
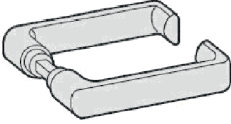
 <p><b>07.14.23</b> DORMA JUNIOR OFFICE KAPI KOLU DORMA JUNIOR OFFICE DOOR HANDLE Renk / Colour : Siyah-Gri Black-Grey</p>	 <p><b>07.14.24</b> DORMA STUDIO RONDO KAPI KOLU DORMA STUDIO RONDO DOOR HANDLE Renk / Colour : Siyah-Gri Black-Grey</p>
 <p><b>07.14.22</b> WSS KAPI KOLU WSS DOOR HANDLE Renk / Colour : Siyah-Gri Black-Grey</p>	

KİLİT GÖVDELERİ / LOCKING FRAME

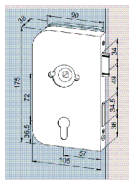
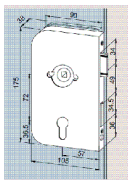
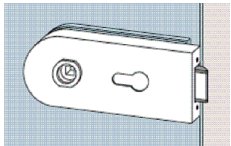
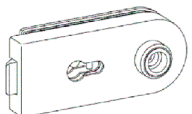
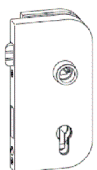
 <p><b>18.01.32L</b> DORMA JUNIOR OFFICE KİLİT GÖVDE DORMA JUNIOR OFFICE LOCK</p>	 <p><b>18.01.32R</b> DORMA JUNIOR OFFICE KİLİT GÖVDE DORMA JUNIOR OFFICE LOCK</p>
 <p><b>18.01.33</b> DORMA STUDIO RONDO KİLİT GÖVDE DORMA STUDIO RONDO LOCK</p>	
 <p><b>18.01.34</b> WSS KİLİT GÖVDE (8mm cam için) WSS LOCK (for 8mm glass)</p>	 <p><b>18.01.35</b> WSS KİLİT GÖVDE (8/10mm cam için) WSS LOCK (for 8/10mm glass)</p>

ALÜMİNYUM KASA CAM KAPI DETAYI İÇİN  
GLASS DOOR WITH ALUMINIUM FRAME DETAIL

MENTEŞELER / HINGES

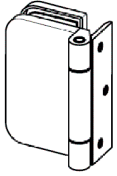

15.02.37

WSS MENTEŞE  
WSS HINGE

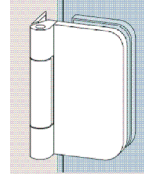

15.02.38

DORMA JUNIOR OFFICE MENTEŞE  
DORMA JUNIOR OFFICE HINGE

KASA KARŞILIKLARI / STRIKER FOR FRAME

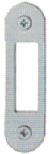

18.02.30

HOPPE KASA KARŞILIĞI  
HOPPE STRIKER FOR FRAME

BARELLER / CYLINDERS

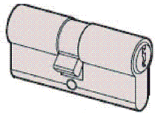

18.04.26

WSS BAREL  
WSS CYLINDER

63mm = 26,5 + 10 + 26,5mm

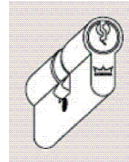

18.04.27

DORMA BAREL  
DORMA CYLINDER

61mm = 25,5 + 10 + 25,5mm

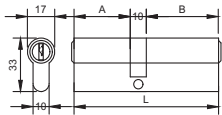

18.04.03

KALE BAREL  
KALE CYLINDER

A	B	L
26	32	68

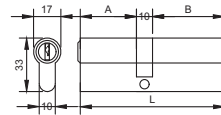

18.04.07

KALE BAREL  
KALE CYLINDER

A	B	L
26	26	62