

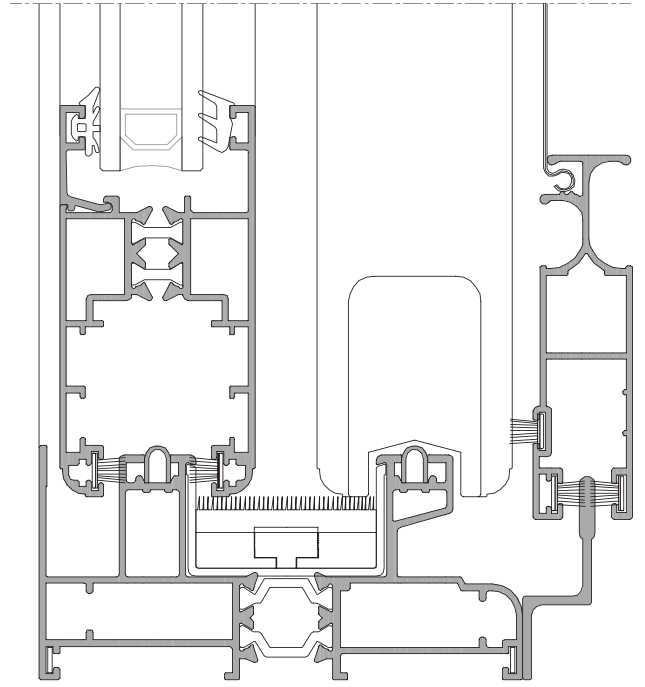

Sürme Sistem  
Sliding System



# S38T



### TEKNİK ÖZELLİKLER / TECHNICAL PROPERTIES

<b>KASA DERİNLİĞİ / FRAME DEPTH</b>	<b>94 - 155,5 mm</b>
<b>KANAT DERİNLİĞİ / SASH DEPTH</b>	<b>38 mm</b>
<b>KENET DERİNLİĞİ / INTERLOCKING DEPTH</b>	<b>88 mm</b>
<b>PROFİL ET KALINLIĞI / PROFILE WALL THICKNESS</b>	<b>1,3 - 1,5 mm</b>
<b>ISI BARIYERİ / THERMAL BREAK</b>	<b>12 - 18 mm</b>
<b>MİN./MAKS. CAM KALINLIĞI / MIN./MAX. GLAZING THICKNESS</b>	<b>6 mm / 22 mm</b>
<b>MİN. KANAT ÖLÇÜLERİ / MIN. SASH DIMENSIONS</b>	<b>800 x 1900 mm</b>
<b>MAKS. KANAT ÖLÇÜLERİ / MAX. SASH DIMENSIONS</b>	<b>1600 x 2800 mm</b>
<b>MAKS. KANAT AĞIRLIĞI / MAX. SASH WEIGHT</b>	<b>160 kg</b>
<b>MİN. TERMAL ISI YALITIMI / MIN. THERMAL INSULATION</b>	<b><math>U_f : 5,14 - 6,86 W / ( m^2 \cdot K )</math></b>

### UYGULAMA SEÇENEKLERİ / APPLICATION OPTIONS

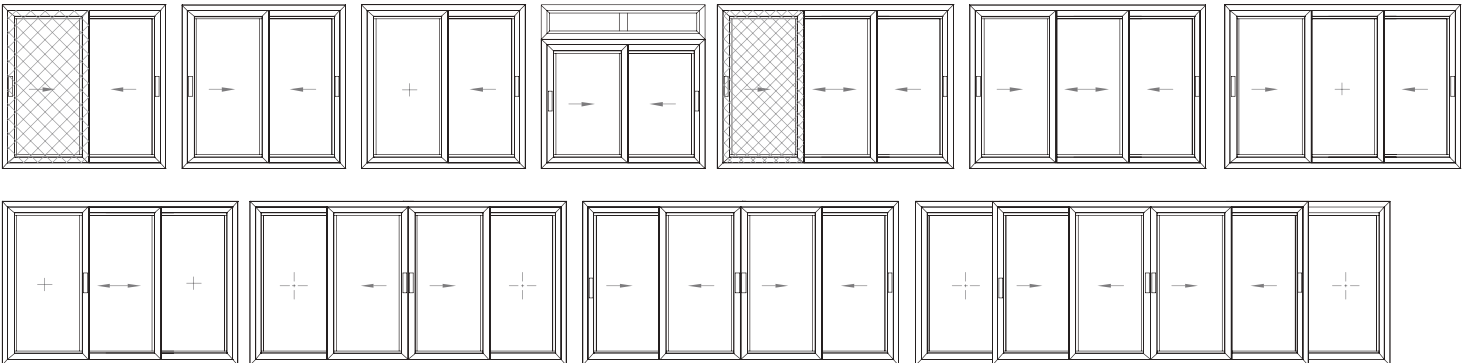

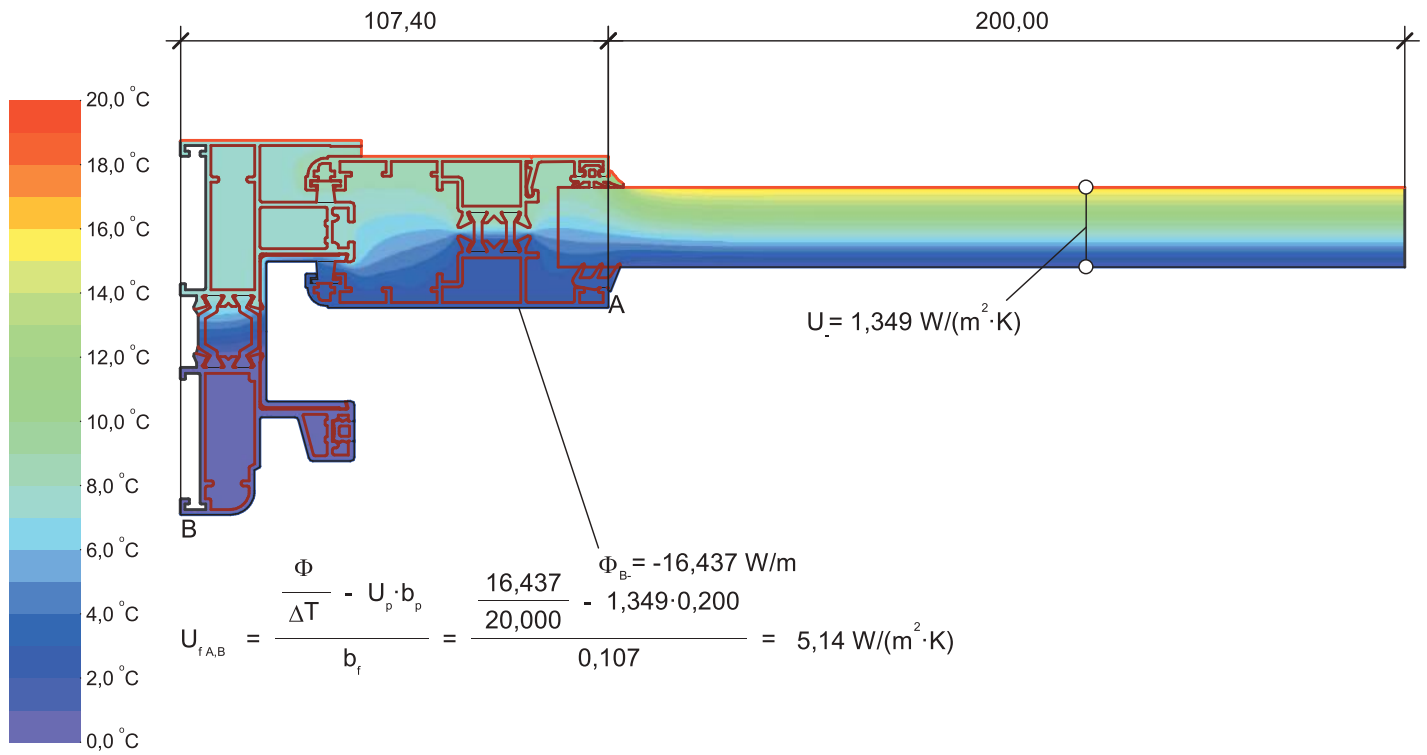

Material	$\lambda$ [W/(m·K)]	$\epsilon$	Boundary Condition	$q$ [W/m <sup>2</sup> ]	$\theta_f$ [°C]	$R$ [(m <sup>2</sup> ·K)/W]	$\epsilon$
Aluminium (Si Alloys)	160,000	0,900	Epsilon 0.9				0,900
EPDM (ethylene propylene diene monomer)	0,250	0,900	Exterior, frame	0,000	0,040		
PVC-U (polyvinylchloride), rigid	0,170	0,900	Interior, normal, horizontal	20,000	0,130		
Panel	0,035	0,900	Symmetry/Model section	0,000			
Polyamid 6.6 with 25% glass fibre	0,300	0,900					
Slightly ventilated air cavity	anisotropic						
Unventilated air cavity	anisotropic						

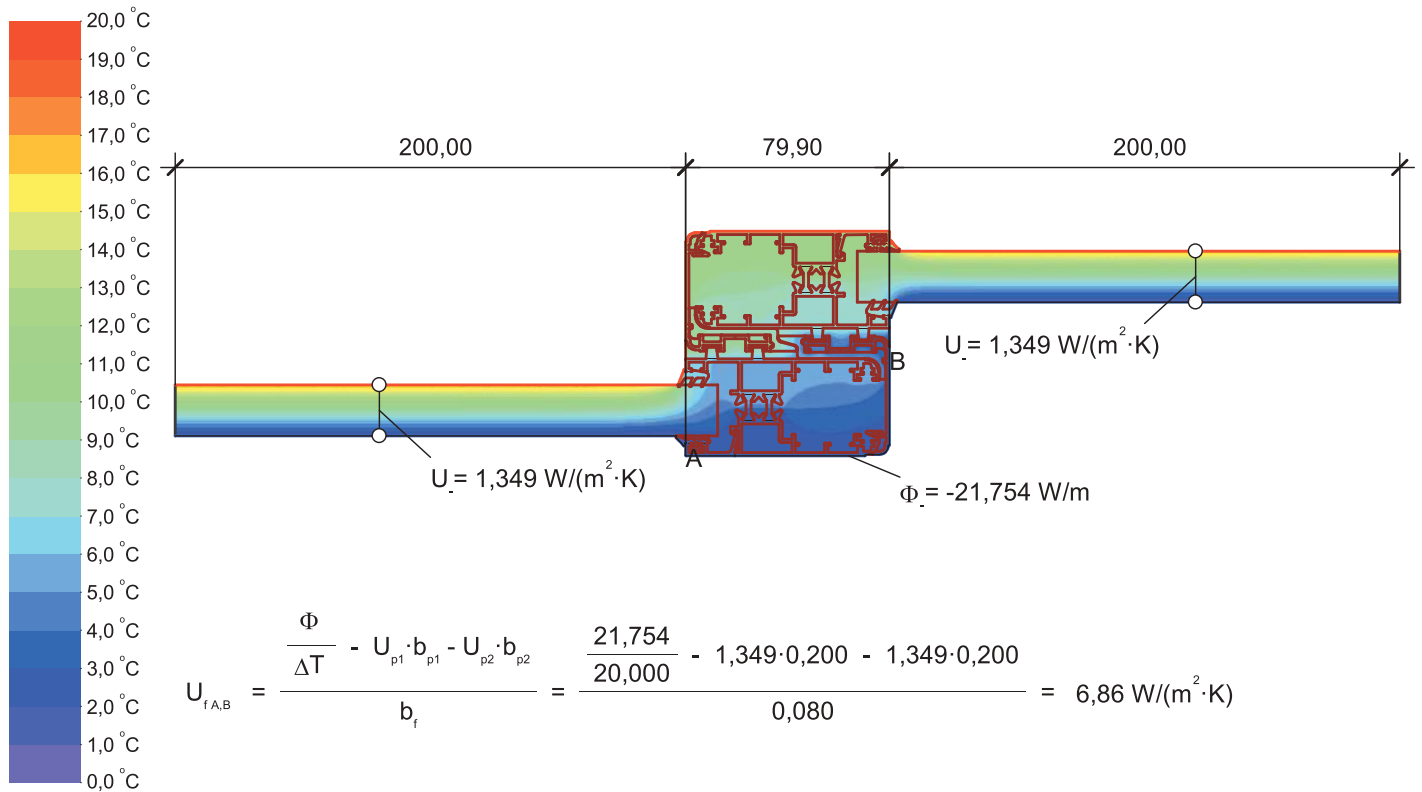





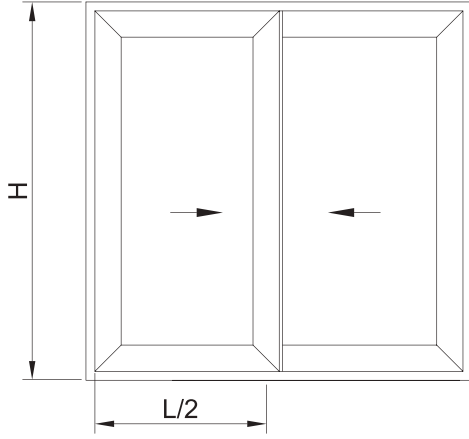
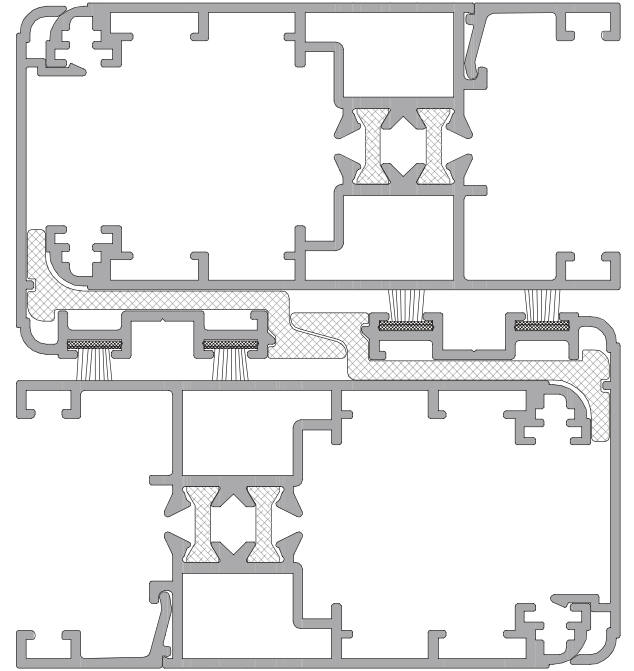
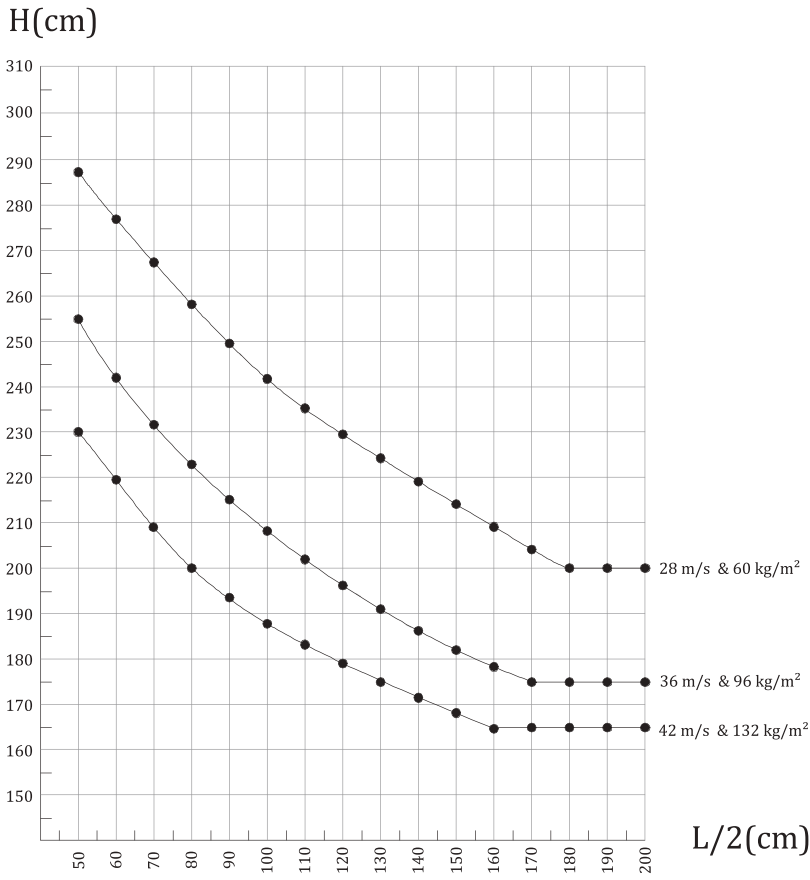

Material	$\lambda$ [W/(m·K)]	$\epsilon$	Boundary Condition	$q$ [W/m <sup>2</sup> ]	$\theta$ [°C]	$R$ [(m <sup>2</sup> ·K)/W]	$\epsilon$
Aluminium (Si Alloys)	160,000	0,900	Epsilon 0.9				0,900
EPDM (ethylene propylene diene monomer)	0,250	0,900	Exterior, frame	0,000	0,040		
PVC (polyvinylchloride), rigid	0,170	0,900	Interior, normal, horizontal	20,000	0,130		
Panel	0,035	0,900	Symmetry/Model section	0,000			
Polyamid 6.6 with 25% glass fibre	0,300	0,900					
Slightly ventilated air cavity	anisotropic						
Unventilated air cavity	anisotropic						

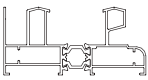
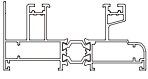
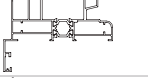
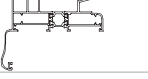

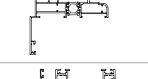

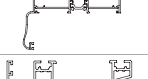
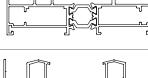
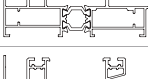
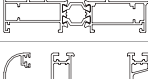

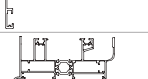
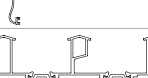
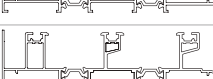
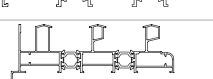
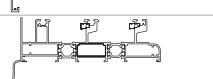
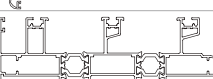
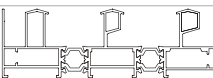
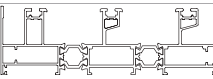
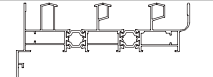
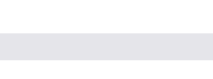



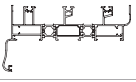

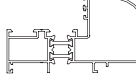
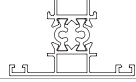

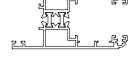
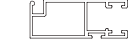
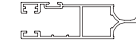



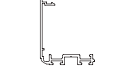

## RÜZGAR YÜKÜNE GÖRE KULLANIM LİMİTLERİ GRAFIĞI

Max. Sehim :  $L / 300$ Jx : 24,88 cm<sup>4</sup>

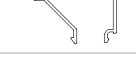

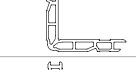

PROFİL KESİTİ PROFILE SECTION	PROFİL KODU PROFILE CODE	PROFİL ADI PROFILE NAME	Jx cm <sup>4</sup>	Jy cm <sup>4</sup>	AĞIRLIK (kg/m) WEIGHT
	2700-2701	İKİ RAYLI KASA PROFİLİ DOUBLE RAIL FRAME PROFILE	48,15 cm <sup>4</sup>	9,79 cm <sup>4</sup>	1,649 kg/mt
	3580-3581	İKİ RAYLI KASA PROFİLİ DOUBLE RAIL FRAME PROFILE	51,49 cm <sup>4</sup>	10,75 cm <sup>4</sup>	1,749 kg/mt
	2818-2701	İKİ RAYLI KASA PROFİLİ DOUBLE RAIL FRAME PROFILE	64,12 cm <sup>4</sup>	17,24 cm <sup>4</sup>	1,847 kg/mt
	3583-3581	İKİ RAYLI KASA PROFİLİ DOUBLE RAIL FRAME PROFILE	71,22 cm <sup>4</sup>	25,40 cm <sup>4</sup>	1,981 kg/mt
	5846-3581	İKİ RAYLI KASA PROFİLİ DOUBLE RAIL FRAME PROFILE	54,62 cm <sup>4</sup>	10,31 cm <sup>4</sup>	1,799 kg/mt
	5846-2701	İKİ RAYLI KASA PROFİLİ DOUBLE RAIL FRAME PROFILE	64,12 cm <sup>4</sup>	17,24 cm <sup>4</sup>	1,948 kg/mt
	5847-3581	İKİ RAYLI SİNEKLİKLİ KASA PROFİLİ DOUBLE RAIL SCREENING FRAME PROFILE	71,91 cm <sup>4</sup>	28,93 cm <sup>4</sup>	2,026 kg/mt
	5847-3582	İKİ RAYLI SİNEKLİKLİ KASA PROFİLİ DOUBLE RAIL SCREENING FRAME PROFILE	95,04 cm <sup>4</sup>	26,95 cm <sup>4</sup>	2,185 kg/mt
	5846-3582	İKİ RAYLI SİNEKLİKLİ KASA PROFİLİ DOUBLE RAIL SCREENING FRAME PROFILE	71,10 cm <sup>4</sup>	11,19 cm <sup>4</sup>	1,952 kg/mt
	2700-3025	İKİ RAYLI SİNEKLİKLİ KASA PROFİLİ DOUBLE RAIL SCREENING FRAME PROFILE	64,30 cm <sup>4</sup>	10,92 cm <sup>4</sup>	1,812 kg/mt
	3580-3582	İKİ RAYLI SİNEKLİKLİ KASA PROFİLİ DOUBLE RAIL SCREENING FRAME PROFILE	67,43 cm <sup>4</sup>	11,77 cm <sup>4</sup>	1,902 kg/mt
	3592-3582	İKİ RAYLI SİNEKLİKLİ KASA PROFİLİ DOUBLE RAIL SCREENING FRAME PROFILE	98,67 cm <sup>4</sup>	13,70 cm <sup>4</sup>	2,128 kg/mt
	2818-3025	İKİ RAYLI SİNEKLİKLİ KASA PROFİLİ DOUBLE RAIL SCREENING FRAME PROFILE	83,48 cm <sup>4</sup>	18,79 cm <sup>4</sup>	2,016 kg/mt
	3583-3582	İKİ RAYLI SİNEKLİKLİ KASA PROFİLİ DOUBLE RAIL SCREENING FRAME PROFILE	90,73 cm <sup>4</sup>	27,05 cm <sup>4</sup>	2,134 kg/mt
	2700-2704-2701	ÜÇ RAYLI KASA PROFİLİ TRIPLE RAIL FRAME PROFILE	159,69 cm <sup>4</sup>	13,26 cm <sup>4</sup>	2,523 kg/mt
	3580-3584-3581	ÜÇ RAYLI KASA PROFİLİ TRIPLE RAIL FRAME PROFILE	272,32 cm <sup>4</sup>	15,76 cm <sup>4</sup>	2,662 kg/mt
	2818-2704-2701	ÜÇ RAYLI KASA PROFİLİ TRIPLE RAIL FRAME PROFILE	210,04 cm <sup>4</sup>	22,02 cm <sup>4</sup>	2,721 kg/mt
	3583-3584-3581	ÜÇ RAYLI KASA PROFİLİ TRIPLE RAIL FRAME PROFILE	228,73 cm <sup>4</sup>	30,78 cm <sup>4</sup>	2,662 kg/mt
	5846-3584-3581	ÜÇ RAYLI KASA PROFİLİ TRIPLE RAIL FRAME PROFILE	178,12 cm <sup>4</sup>	14,86 cm <sup>4</sup>	2,713 kg/mt
	2700-2704-3025	ÜÇ RAYLI SİNEKLİKLİ KASA PROFİLİ TRIPLE RAIL SCREENING FRAME PROFILE	207,36 cm <sup>4</sup>	15,76 cm <sup>4</sup>	2,700 kg/mt
	3580-3584-3582	ÜÇ RAYLI SİNEKLİKLİ KASA PROFİLİ TRIPLE RAIL SCREENING FRAME PROFILE	217,09 cm <sup>4</sup>	17,08 cm <sup>4</sup>	2,815 kg/mt
	2818-2704-3025	ÜÇ RAYLI SİNEKLİKLİ KASA PROFİLİ TRIPLE RAIL SCREENING FRAME PROFILE	249,90 cm <sup>4</sup>	23,51 cm <sup>4</sup>	2,898 kg/mt

\*\* Her profil için minimum sipariş 300 kg'dır.  
\*\* Minimum order quantity is 300 kg per profile.

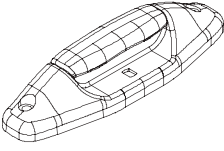
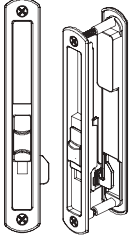
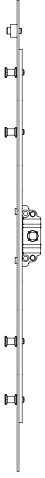
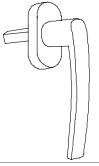
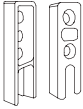
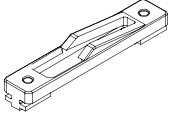

PROFİL KESİTİ PROFILE SECTION	PROFİL KODU PROFILE CODE	PROFİL ADI PROFILE NAME	Jx cm <sup>4</sup>	Jy cm <sup>4</sup>	AĞIRLIK (kg/m) WEIGHT
	3583-3584-3582	ÜÇ RAYLI SİNEKLİK KASA PROFİLİ TRIPLE RAIL SCREENING FRAME PROFILE	268,33 cm <sup>4</sup>	32,31 cm <sup>4</sup>	3,047 kg/mt
	2705-2705	SABİT KASA PROFİLİ FIXED FRAME PROFILE	-	-	1,485 kg/mt
	1932-1933	SABİT KASA PROFİLİ FIXED FRAME PROFILE	-	-	1,478 kg/mt
	3588-3589	ORTA KAYIT PROFİLİ MULLION PROFILE	-	-	0,942 kg/mt
	2798-2798	KANAT İÇİ ORTA KAYIT PROFİLİ SASH INTERNAL MULLION PROFILE	-	-	1,021 kg/mt
	3588-3588	KANAT İÇİ ORTA KAYIT PROFİLİ SASH INTERNAL MULLION PROFILE	-	-	1,134 kg/mt
	3585-3586	KANAT PROFİLİ SASH PROFILE	-	-	1,289 kg/mt
	1243	SİNEKLİK PROFİLİ SCREENING PROFILE	-	-	0,434 kg/mt
	12339	SİNEKLİK PROFİLİ SCREENING PROFILE	-	-	0,703 kg/mt
	3591	ADAPTÖR PROFİLİ ADAPTER PROFILE	-	-	0,112 kg/mt
	2819	ADAPTÖR PROFİLİ ADAPTER PROFILE	-	-	0,093 kg/mt
	3590-3590	ADAPTÖR PROFİLİ ADAPTER PROFILE	-	-	0,454 kg/mt
	3594	TAKVİYE PROFİLİ REINFORCE PROFILE	-	-	0,456 kg/m
	3595	TAKVİYE KAPAK PROFİLİ REINFORCE COVER PROFILE	-	-	0,101 kg/m
	2703	KENET PROFİLİ INTERLOCK PROFILE	-	-	0,403 kg/mt
	2707	SİNEKLİK RAY PROFİLİ SCREENING RAIL PROFILE	-	-	0,190 kg/mt
	3587	ÇITA PROFİLİ BEAD PROFILE	-	-	0,140 kg/mt
	3598	ÇITA PROFİLİ BEAD PROFILE	-	-	0,263 kg/mt
	1684	ÇITA PROFİLİ BEAD PROFILE	-	-	0,325 kg/mt
	6877	RAY PROFİLİ RAIL PROFILE	-	-	0,0061 kg/mt
	598	KÖŞE TAKOZ PROFİLİ CORNER WEDGE PROFILE	-	-	1,677 kg/mt
	1662	KÖŞE TAKOZ PROFİLİ CORNER WEDGE PROFILE	-	-	2,576 kg/mt

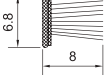
\*\* Her profil için minimum sipariş 300 kg'dır.  
\*\* Minimum order quantity is 300 kg per profile.

AKSESUAR ACCESSORY	STOK KODU REFERENCE CODE	AKSESUAR ADI DESCRIPTION	AKSESUAR KODU PRODUCT CODE	PAKET PACK
	03 010615	RAY KAPAK FİTİLİ RAIL COVER GASKET	S38T - KRF.05	330 mt / paket 10 kg
	03 011230	İÇ CAM FİTİLİ INNER GLAZING GASKET	S38T - İCF.30	280 mt / paket 10 kg
	03 011231	İÇ CAM FİTİLİ INNER GLAZING GASKET	S38T - İCF.40	220 mt / paket 10 kg
	03 010732	İÇ CAM FİTİLİ INNER GLAZING GASKET	S38T - İCF.50	185 mt / paket 10 kg
	03 010436	KASA FİTİLİ FRAME GASKET	S38T - KBF.36	300 mt / paket 10 kg
	03 010446	KASA FİTİLİ FRAME GASKET	S38T - KBF.46	275 mt / paket 10 kg
	03 010456	KANAT FİTİLİ SASH GASKET	S38T-KBF.56	330 mt / paket 10 kg/mt
	03 010503	DIŞ CAM FİTİLİ OUTER GLAZING GASKET	S38T - DCF.30	195 mt / paket 10 kg
	03 011035	ORTA BİNİ FİTİLİ MIDDLE GASKET	S38T- OBF.55	54 mt / paket 10 kg
	01 071051	KENET YALITIM PLASTİĞİ INTERLOCKING INSULATION PART	S38T- KYP.51	1 boy / 6 m
	01 071050	KASA OLUK PLASTİĞİ FRAME GUTTER PART	S38T-KP.50	1 boy / 6 m
	01 071027	İSPANYOLET ADAPTÖRÜ ESPAGNOLET ADAPTER	S38T - İA.027	100 ad / paket
	01 071021	STOPER STOPPER	S38T - SP.021	100 ad / paket
	01 071022	KENET KAPAĞI INTERLOCKING CORNER CAP	S38T - KP.022	100 ad / paket
	01 071024	ALT HAVA KESİCİ BOTTOM AIR BLOCKER	S38T - AHK.024	100 ad / paket
	01 071030	ÜST HAVA KESİCİ TOP AIR BLOCKER	S38T - ÜHK.030	1 ad / paket

AKSESUAR ACCESSORY	STOK KODU REFERENCE CODE	AKSESUAR ADI DESCRIPTION	AKSESUAR KODU PRODUCT CODE	PAKET PACK
	01 071012	SÜRME PARİZYEN KOL SLIDING HANDLE (PARISIANA)	S38T - PK.12	1 ad / paket
	05 010903	SÜRME KİLİT SLIDING LOCK	S38T - SK.903	1 ad / paket
	05 010907	ANAHTARLI SÜRME KİLİT SLIDING LOCK	S38T - SK.907	1 ad / paket
	06 010270	İSPANYOLET (40 cm) ESPAGNOLETTE (40 cm)	S38T-İSP.270	1 ad / paket
	06 010271	İSPANYOLET (60 cm) ESPAGNOLETTE (60 cm)	S38T-İSP.271	1 ad / paket
	06 010272	İSPANYOLET (80 cm) ESPAGNOLETTE (80 cm)	S38T-İSP.272	1 ad / paket
	06 010273	İSPANYOLET (100 cm) ESPAGNOLETTE (100 cm)	S38T-İSP.273	1 ad / paket
	06 010274	İSPANYOLET (120 cm) ESPAGNOLETTE (120 cm)	S38T-İSP.274	1 ad / paket
	06 010275	İSPANYOLET (140 cm) ESPAGNOLETTE (140 cm)	S38T-İSP.275	1 ad / paket
	06 010276	İSPANYOLET (160 cm) ESPAGNOLETTE (160 cm)	S38T-İSP.276	1 ad / paket
	06 010277	İSPANYOLET (180 cm) ESPAGNOLETTE (180 cm)	S38T-İSP.277	1 ad / paket
	06 010278	İSPANYOLET (200 cm) ESPAGNOLETTE (200 cm)	S38T-İSP.278	1 ad / paket
	01 200291	ROTO SECUSTİK PENCERE KOLU ROTO WINDOW HANDLE	S38T-RK.291	1 Pk / 20 Ad
	06 150520	SÜRME İSPANYOLET KARŞILIK (ZAMAK) SLIDING ESPAGNOLETTE STRIKER (ZAMAK)	S38T-KK.520	1 koli / 500ad
	01 200440	İSPANYOLET KARŞILIK ESPAGNOLETTE STRIKER	S38T-İK.440	25 ad / paket
	04 010230	S38T PASLANMEZ ÇELİK RAY S38T STAINLESS STEEL RAIL 7,3 mm	S38T - PÇR.230	1 boy / 6 m
	03 050711	FIRÇA FİTİL WEATHER STRIP	S38T - FÇ.711	250 mt / paket
	03 050708	FIRÇA FİTİL WEATHER STRIP	S38T - FÇ.708	350 mt / paket

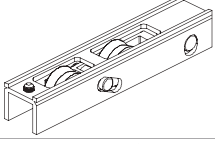
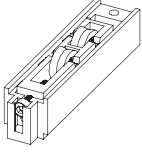
AKSESUAR ACCESSORY	STOK KODU REFERENCE CODE	AKSESUAR ADI DESCRIPTION	AKSESUAR KODU PRODUCT CODE	PAKET PACK
	01 050750	FORZA YAYLI HAVUZ KOL (SİYAH) FORZA RECESSED HANDLE AUTOMATIC (BLACK)	S38T-FHK.750	1 pk / 40ad
	01 050751	FORZA YAYLI HAVUZ KOL (BEYAZ) FORZA RECESSED HANDLE AUTOMATIC (WHITE)	S38T-FHK.751	1 pk / 40ad
	01 050752	FORZA YAYLI HAVUZ KOL (NATUREL) FORZA RECESSED HANDLE AUTOMATIC (NATURAL)	S38T-FHK.752	1 pk / 40ad
	01 050753	FORZA YAYLI HAVUZ KOL (ANTRASİT) FORZA RECESSED HANDLE AUTOMATIC (ANTHRACITE)	S38T-FHK.753	1 pk / 40ad
	01 050760	FORZA MANUEL HAVUZ KOL (SİYAH) FORZA RECESSED HANDLE MANUEL (BLACK)	S38T-FHK.760	1 pk / 40ad
	01 050761	FORZA MANUEL HAVUZ KOL(BEYAZ) FORZA RECESSED HANDLE MANUEL (WHITE)	S38T-FHK.761	1 pk / 40ad
	01 050762	FORZA MANUEL HAVUZ KOL (NATUREL) FORZA RECESSED HANDLE MANUEL (NATURAL)	S38T-FHK.762	1 pk / 40ad
	01 050763	FORZA MANUEL HAVUZ KOL (ANTRASİT) FORZA RECESSED HANDLE MANUEL (ANTHRACITE)	S38T-FHK.763	1 pk / 40ad
	01 050770	FORZA ANAHTARLI HAVUZ KOL (SİYAH) FORZA RECESSED HANDLE LOCK WITH KEY (BLACK)	S38T-FHK.770	1 pk / 40ad
	01 050771	FORZA ANAHTARLI HAVUZ KOL (BEYAZ) FORZA RECESSED HANDLE LOCK WITH KEY (WHITE)	S38T-FHK.771	1 pk / 40ad
	01 050772	FORZA ANAHTARLI HAVUZ KOL (NATUREL) FORZA RECESSED HANDLE LOCK WITH KEY (NATURAL)	S38T-FHK.772	1 pk / 40ad
	01 050773	FORZA ANAHTARLI HAVUZ KOL (ANTRASİT) FORZA RECESSED HANDLE LOCK WITH KEY (ANTHRACITE)	S38T-FHK.773	1 pk / 40ad
	01 050790	FORZA PASİF HAVUZ KOL (SİYAH) FORZA RECESSED FINGER PULL HANDLE (BLACK)	S38T-FHK.790	1 pk / 40 ad
	01 050791	FORZA PASİF HAVUZ KOL (BEYAZ) FORZA RECESSED FINGER PULL HANDLE (WHITE)	S38T-FHK.791	1 pk / 40 ad
	01 050792	FORZA PASİF HAVUZ KOL (NATUREL) FORZA RECESSED FINGER PULL HANDLE (NATURAL)	S38T-FHK.792	1 pk / 40 ad
	01 050793	FORZA PASİF HAVUZ KOL (ANTRASİT) FORZA RECESSED FINGER PULL HANDLE (NATURAL)	S38T-FHK.793	1 pk / 40 ad
	01 050781	FORZA KİLİT DİLİ (ZAMAK) FORZA HOOK (ZAMAK)  Forza yaylı ve manuel havuz kol ile kullanılmaktadır.	S38T-FKD.781	1 pk / 40 ad
	01 050780	FORZA KİLİT DİLİ (ZAMAK) FORZA HOOK (ZAMAK)	S38T-FKD.780	1 pk / 40 ad
	01 050782	FORZA KİLİT KARŞILIĞI (ZAMAK) FORZA STRIKER (ZAMAK)	S38T-FKK.782	1 pk / 40 ad

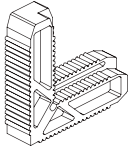
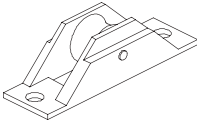
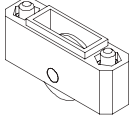
AKSESUAR ACCESSORY	STOK KODU REFERENCE CODE	AKSESUAR ADI DESCRIPTION	AKSESUAR KODU PRODUCT CODE		PAKET PACK
	01 110140	ALÜMİNYUM ÇİFTLİ RULMAN ALUMINIUM ROLLER(DOUBLE-150 KG)	S38T - ÇR.140	80 KG	1 ad / paket
	01 071020	ÇİFTLİ RULMAN ROLLER(DOUBLE-100 KG)	S38T - ÇR.020		1 ad / paket
	01 130318	KÖŞE GÖNYE CORNER BRACKET	S38T - KG.318		1000 ad / paket
	01 130307	ALYAN KÖŞE BAĞLANTI ALLEN CORNER JOINT	S38T-MC.307		250 ad / paket
	06 140203	CAM TAKOZU (3X20X80 mm) GLAZING WEDGE 3mm	S38T - CT.203		1000 ad / paket
	04 105018	SİNEKLİK HAVUZ KOL SCREENING ROLLER	S38T - SHK.018		100 ad / paket
	04 105070	SİNEKLİK KÖŞE TAKOZ SCREENING CORNER WEDGE	S38T - ST.070		100 ad / paket
	04 105060	SİNEKLİK RULMAN SCREENING ROLLER	S38T - SR.60		100 ad / paket
	04 100120	SİNEKLİK KÖŞE BAĞLANTI SCREENING CORNER CONNECTION	S38T-SC.150		4 ad / paket
	04 100121	SİNEKLİK RULMAN SCREENING ROLLER	S38T-PR.140		500 ad / paket
	04 060080 - 80cm	SİNEKLİK TÜLÜ SCREENING NET	S38T - STF.80		24 m <sup>2</sup> / paket
	04 060100 - 100cm		S38T - STF.100		30 m <sup>2</sup> / paket
	04 060120 - 120cm		S38T - STF.120		36 m <sup>2</sup> / paket
	04 060140 - 140cm		S38T - STF.140		44 m <sup>2</sup> / paket
	04 060160 - 160cm		S38T - STF.160		48 m <sup>2</sup> / paket
	03 020114	SİNEKLİK FITİLİ SCREENING GASKET	S38T - SF.114		100 mt / paket
	03 020115		S38T - SF.115		
	03 020116		S38T - SF.116		

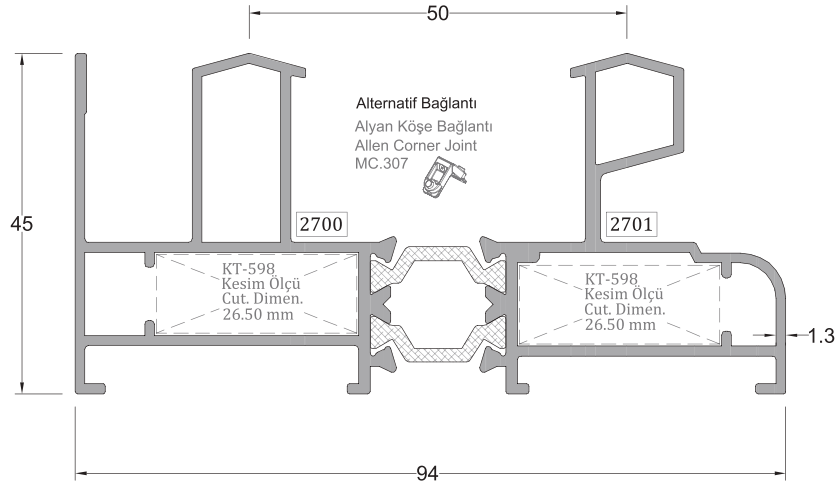

İki Raylı Kasa Profili DOUBLE RAIL FRAME PROFILE	Profil Kodu Profile Code	(kg/mt) Weight	Jx cm <sup>4</sup>	Jy cm <sup>4</sup>
	2700-2701	1,649	48,15	9,79

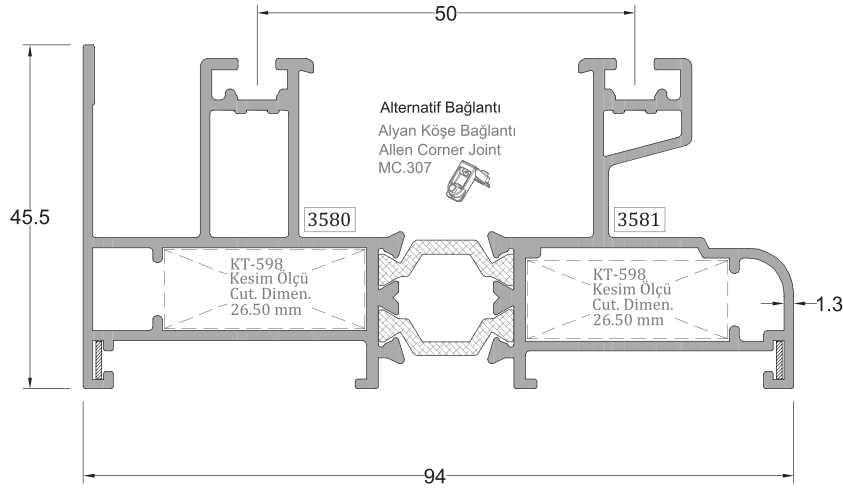

İki Raylı Kasa Profili DOUBLE RAIL FRAME PROFILE	Profil Kodu Profile Code	(kg/mt) Weight	Jx cm <sup>4</sup>	Jy cm <sup>4</sup>
	3580-3581	1,749	51,49	10,75



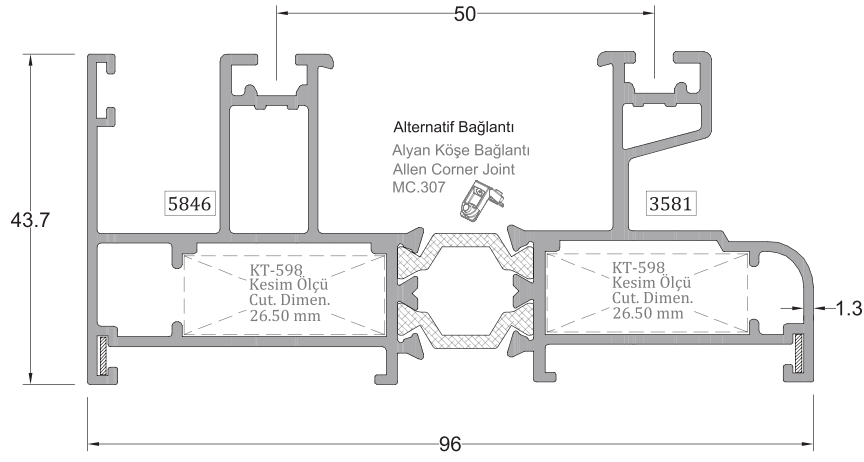

İki Raylı Kasa Profili DOUBLE RAIL FRAME PROFILE	Profil Kodu Profile Code	(kg/mt) Weight	Jx cm <sup>4</sup>	Jy cm <sup>4</sup>
	5846-3581	1,799	54,62	10,31

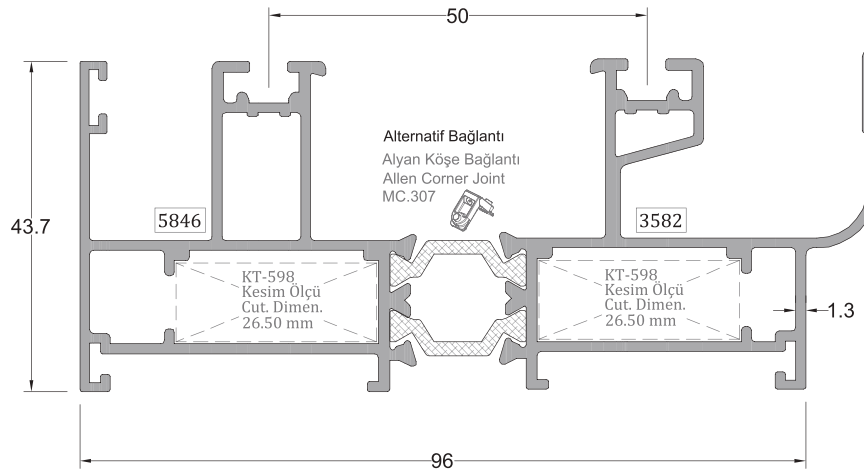

İki Raylı Kasa Profili DOUBLE RAIL FRAME PROFILE	Profil Kodu Profile Code	(kg/mt) Weight	Jx cm <sup>4</sup>	Jy cm <sup>4</sup>
	5846-3582	1,952	71,10	11,19

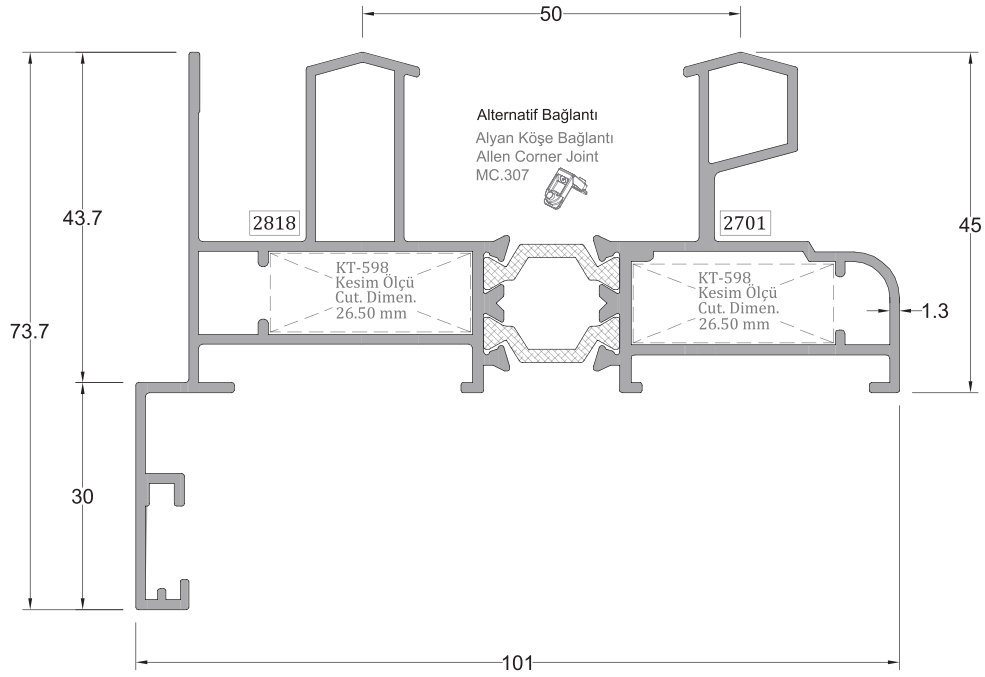

İki Raylı Kasa Profili DOUBLE RAIL FRAME PROFILE	Profil Kodu Profile Code	(kg/mt) Weight	Jx cm <sup>4</sup>	Jy cm <sup>4</sup>
	2818-2701	1,847	64,12	17,24

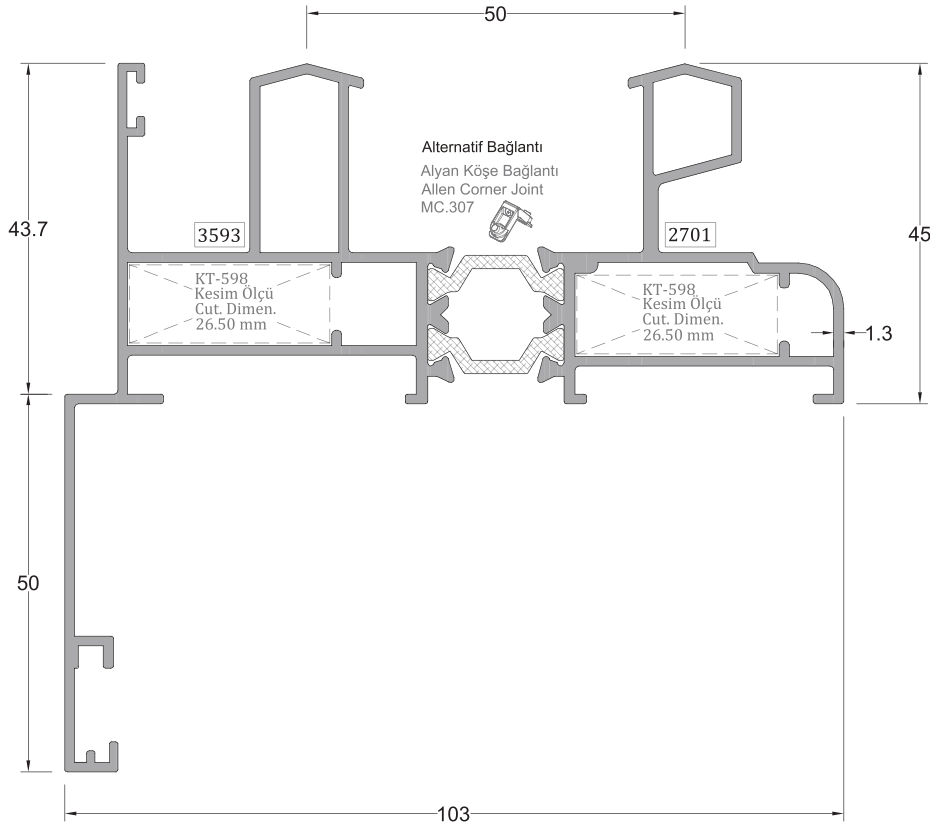

İki Raylı Kasa Profili DOUBLE RAIL FRAME PROFILE	Profil Kodu Profile Code	(kg/mt) Weight	Jx cm <sup>4</sup>	Jy cm <sup>4</sup>
	3593-2701	1,948	64,12	17,24

\*\* Her profil için minimum sipariş 300 kg'dır.  
\*\* Minimum order quantity is 300 kg per profile.

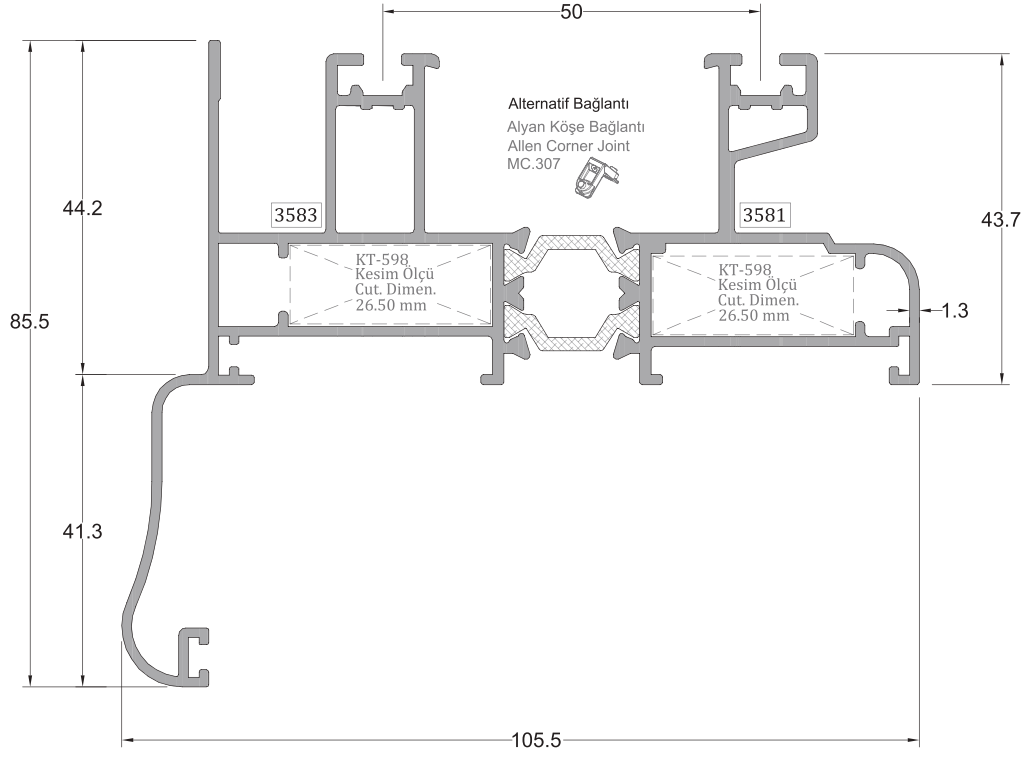

İki Raylı Kasa Profili DOUBLE RAIL FRAME PROFILE	Profil Kodu Profile Code	(kg/mt) Weight	Jx cm <sup>4</sup>	Jy cm <sup>4</sup>
	3583-3581	1,981	71,22	25,40

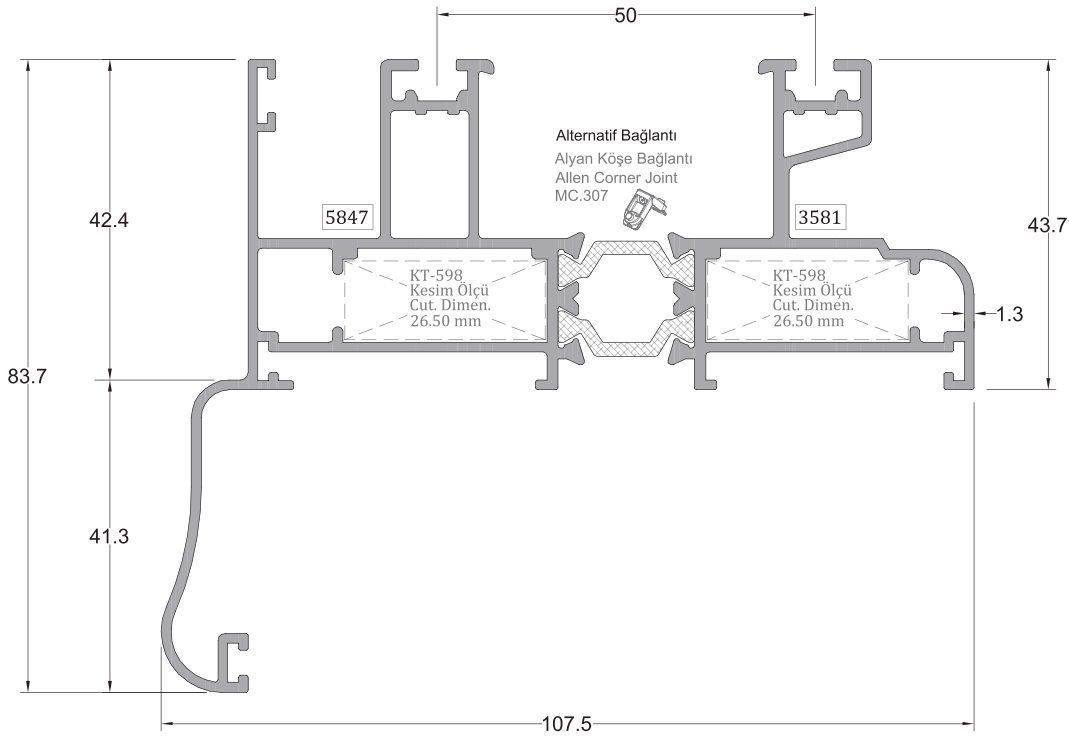

İki Raylı Kasa Profili DOUBLE RAIL FRAME PROFILE	Profil Kodu Profile Code	(kg/mt) Weight	Jx cm <sup>4</sup>	Jy cm <sup>4</sup>
	5847-3581	2,026	71,91	28,33

\*\* Her profil için minimum sipariş 300 kg'dır.  
\*\* Minimum order quantity is 300 kg per profile.

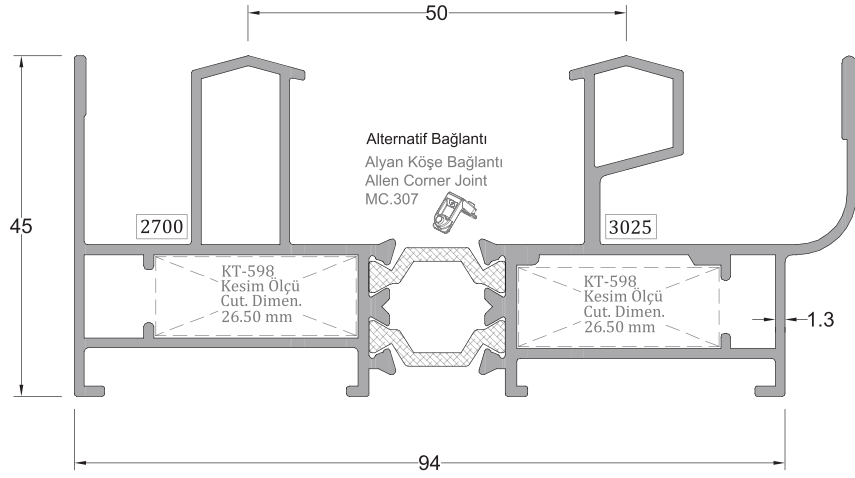

İki Raylı Sineklikli Kasa Profili DOUBLE RAIL SCREENING FRAME PROFILE	Profil Kodu Profile Code	(kg/mt) Weight	Jx cm <sup>4</sup>	Jy cm <sup>4</sup>
	2700-3025	1,812	64,30	10,92

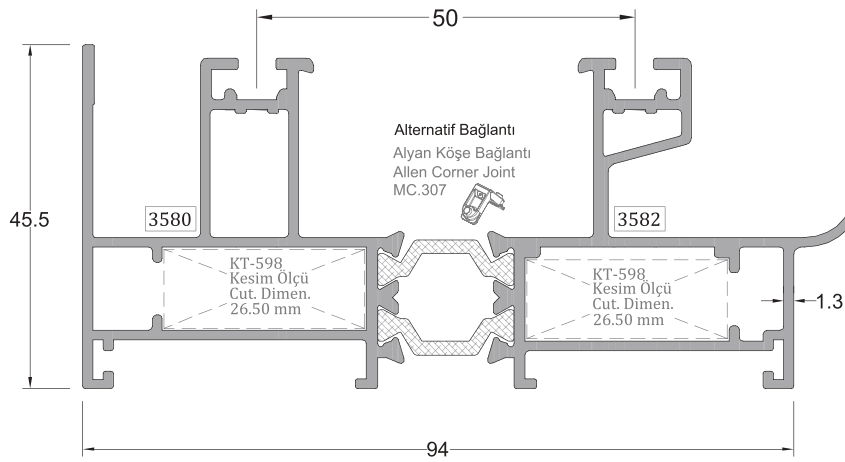

İki Raylı Sineklikli Kasa Profili DOUBLE RAIL SCREENING FRAME PROFILE	Profil Kodu Profile Code	(kg/mt) Weight	Jx cm <sup>4</sup>	Jy cm <sup>4</sup>
	3580-3582	1,902	67,43	11,77

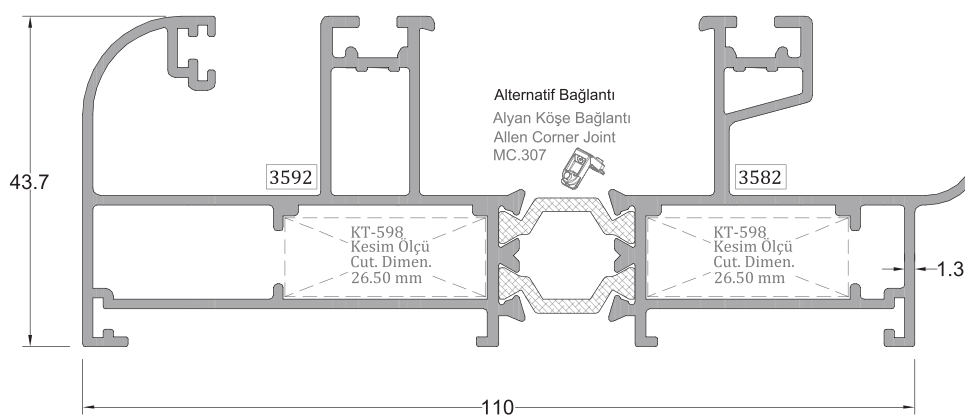

İki Raylı Sineklikli Kasa Profili DOUBLE RAIL SCREENING FRAME PROFILE	Profil Kodu Profile Code	(kg/mt) Weight	Jx cm <sup>4</sup>	Jy cm <sup>4</sup>
	3592-3582	2,128	98,67	13,70

\*\* Her profil için minimum sipariş 300 kg'dır.  
\*\* Minimum order quantity is 300 kg per profile.

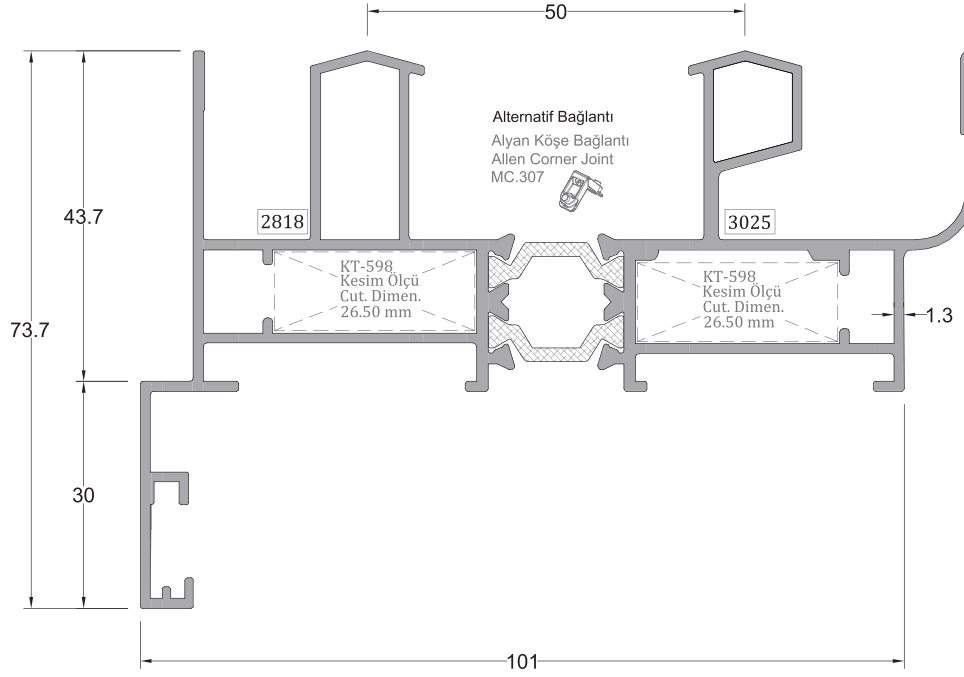

İki Raylı Sineklikli Kasa Profili DOUBLE RAIL SCREENING FRAME PROFILE	Profil Kodu	(kg/mt)	Jx cm <sup>4</sup>	Jy cm <sup>4</sup>
	Profile Code	Weight		
	2818-3025	2,016	83,48	18,79

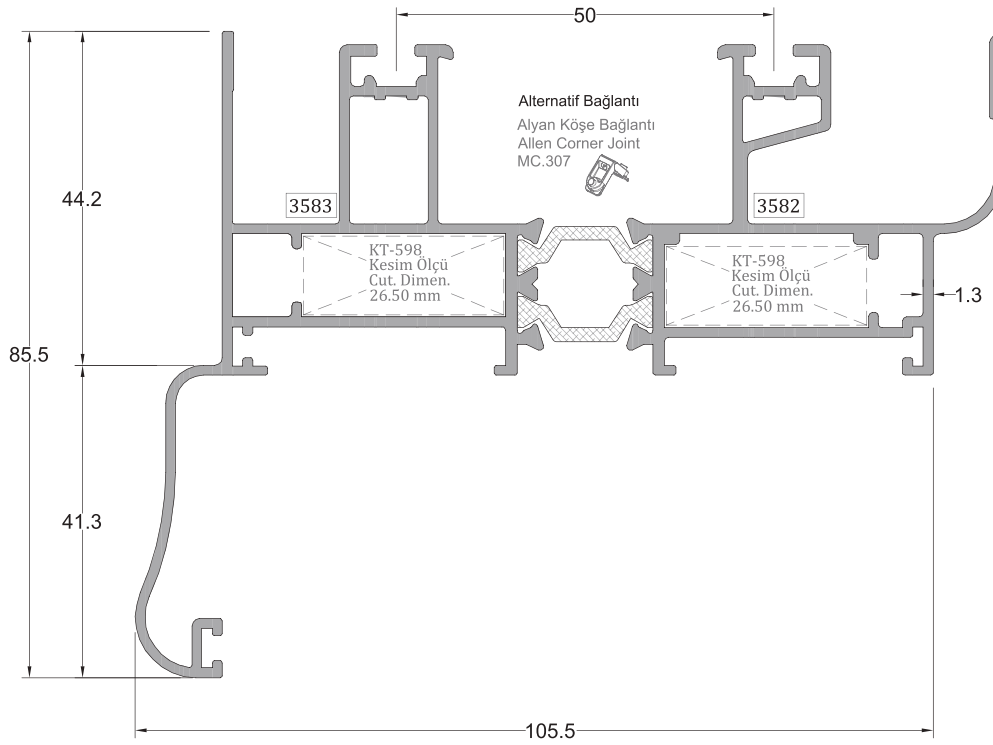

İki Raylı Sineklikli Kasa Profili DOUBLE RAIL SCREENING FRAME PROFILE	Profil Kodu	(kg/mt)	Jx cm <sup>4</sup>	Jy cm <sup>4</sup>
	Profile Code	Weight		
	3583-3582	2,134	90,73	27,05

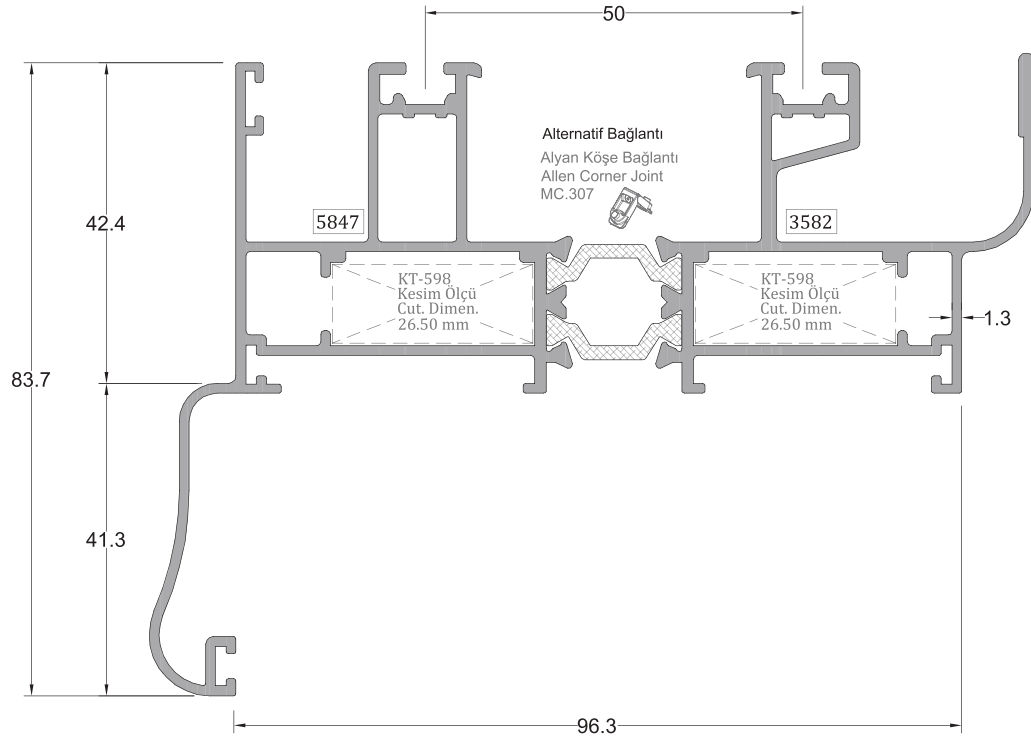

İki Raylı Sineklilikli Kasa Profili  
DOUBLE RAIL SCREENING FRAME PROFILE

Profil Kodu Profile Code	(kg/mt) Weight	Jx cm <sup>4</sup>	Jy cm <sup>4</sup>
5847-3582	2,185	95,04	26,95

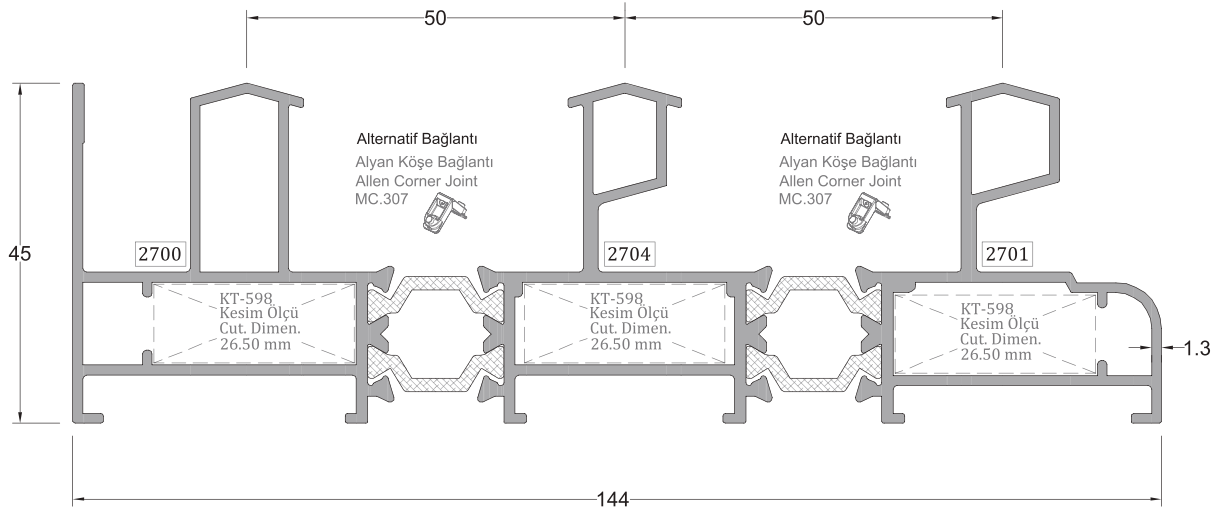

Üç Raylı Kasa Profili  
TRIPLE RAIL FRAME PROFILE

Profil Kodu Profile Code	(kg/mt) Weight	Jx cm <sup>4</sup>	Jy cm <sup>4</sup>
2700-2704-2701	2,523	159,69	13,26

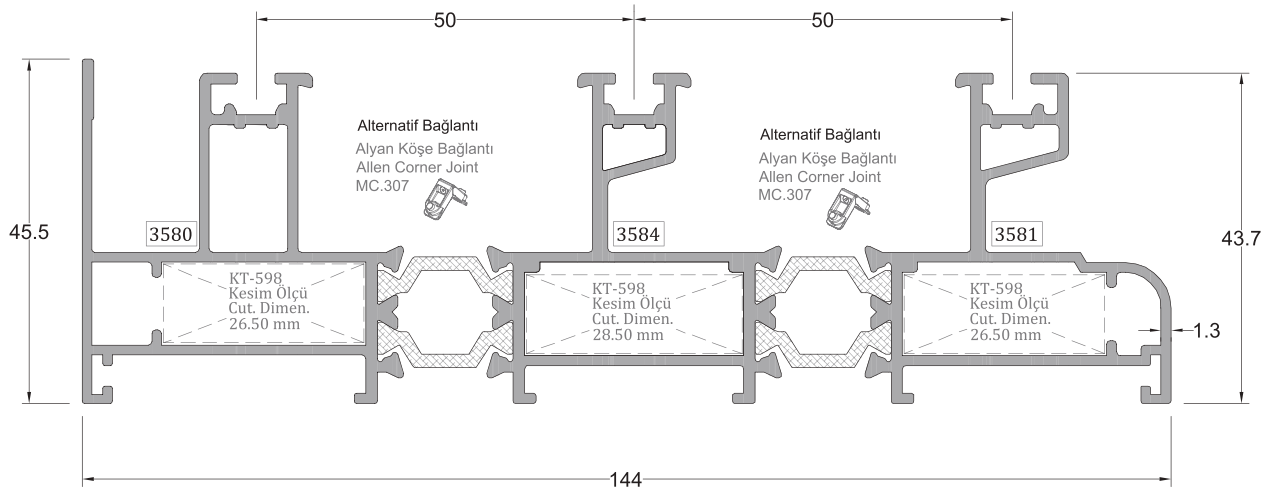

Üç Raylı Kasa Profili TRIPLE RAIL FRAME PROFILE	Profil Kodu Profile Code	(kg/mt) Weight	Jx cm <sup>4</sup>	Jy cm <sup>4</sup>
	3580-3584-3581	2,662	272,32	17,50

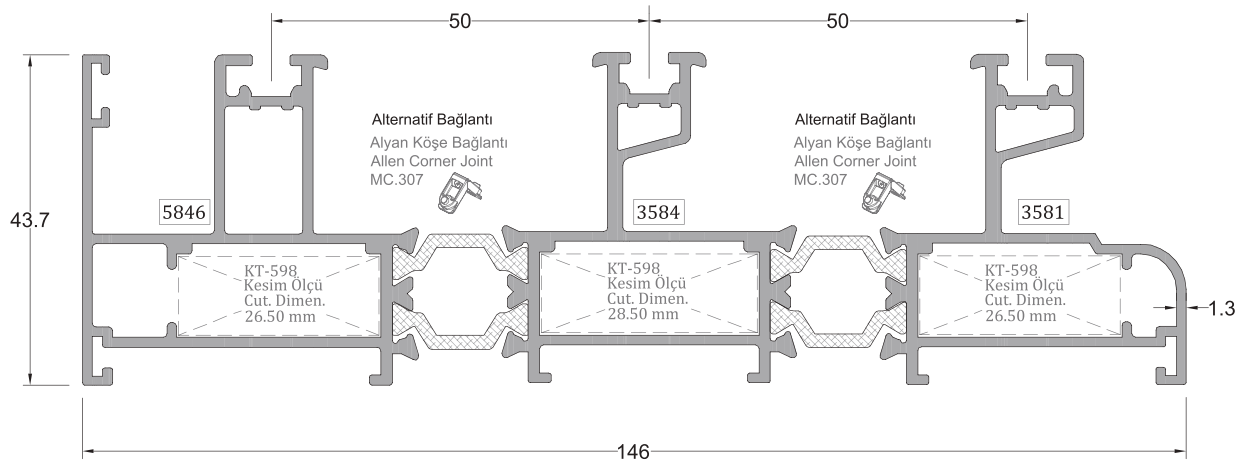

Üç Raylı Kasa Profili TRIPLE RAIL FRAME PROFILE	Profil Kodu Profile Code	(kg/mt) Weight	Jx cm <sup>4</sup>	Jy cm <sup>4</sup>
	5846-3584-3581	2,713	178,12	14,86

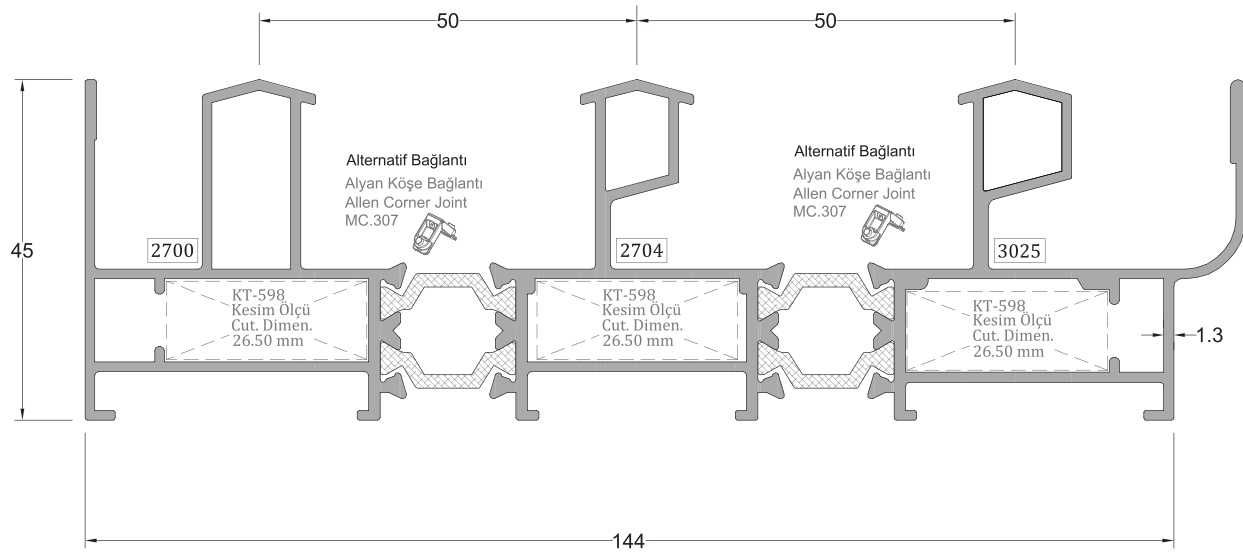

Üç Raylı Sineklikli Kasa Profili TRIPLE RAIL SCREENING FRAME PROFILE	Profil Kodu	(kg/mt)	Jx cm <sup>4</sup>	Jy cm <sup>4</sup>
	Profile Code	Weight		
	2700-2704-3025	2,700	207,36	15,76

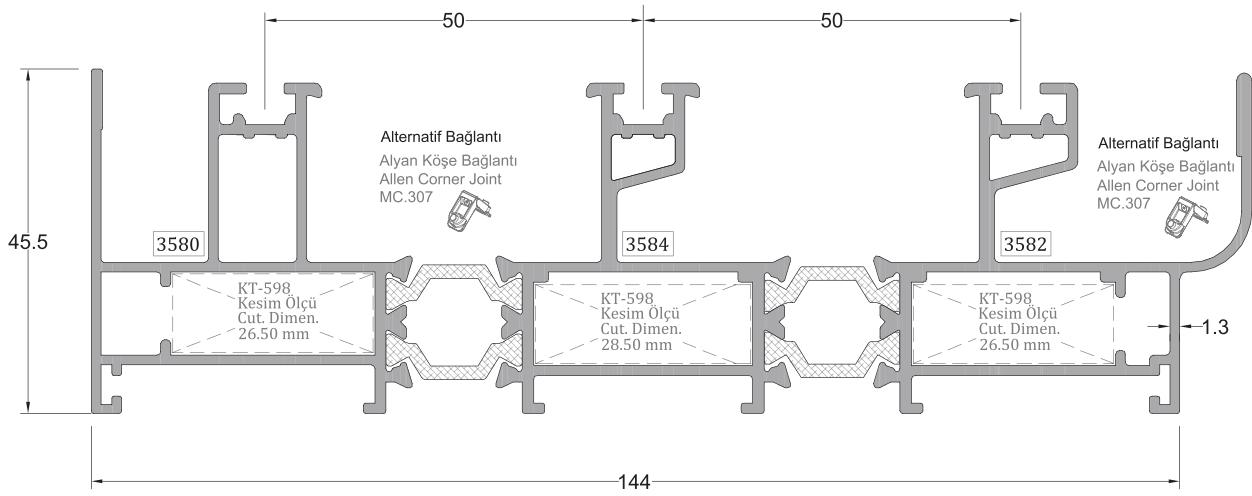

Üç Raylı Sineklikli Kasa Profili TRIPLE RAIL SCREENING FRAME PROFILE	Profil Kodu	(kg/mt)	Jx cm <sup>4</sup>	Jy cm <sup>4</sup>
	Profile Code	Weight		
	3580-3584-3582	2,815	217,09	17,08



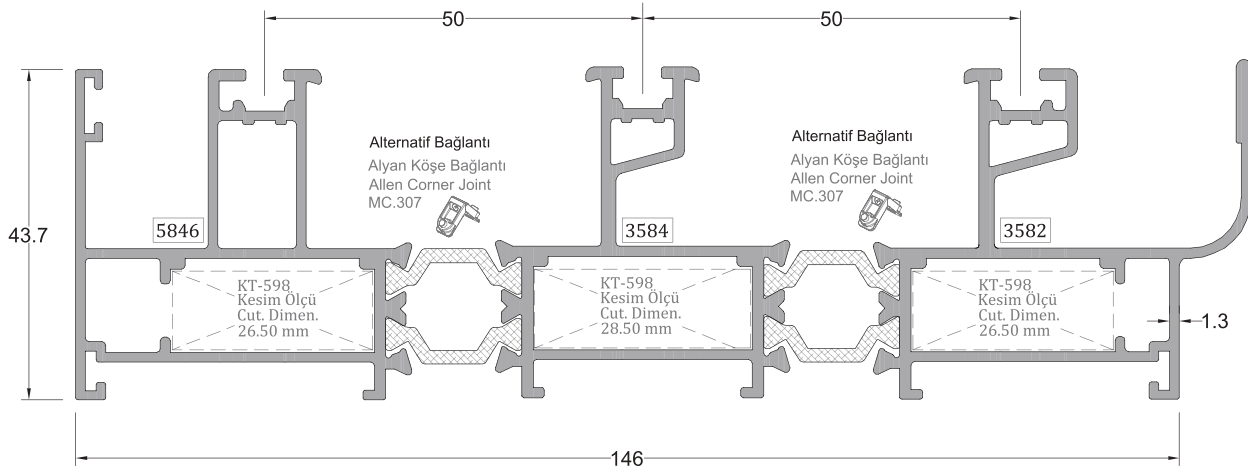

Üç Raylı Sineklikli Kasa Profili TRIPLE RAIL SCREENING FRAME PROFILE	Profil Kodu Profile Code	(kg/mt) Weight	Jx cm <sup>4</sup>	Jy cm <sup>4</sup>
	5846-3584-3582	2,866	207,36	15,76

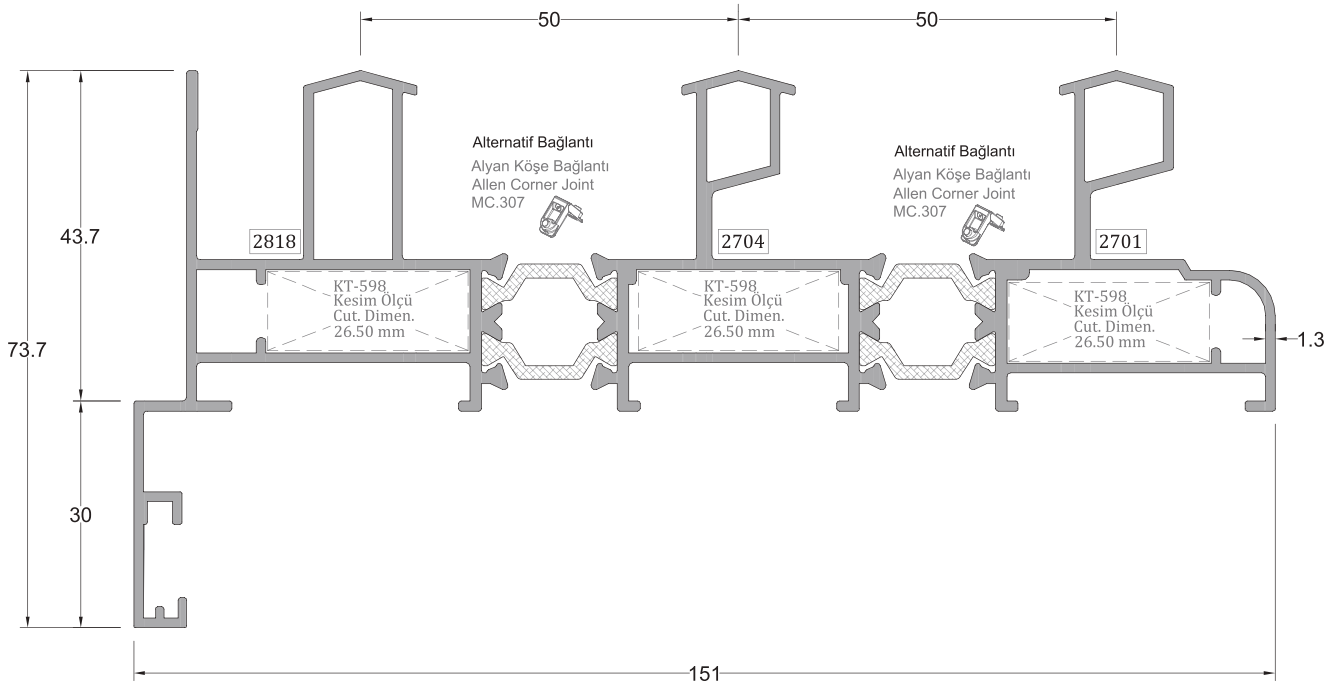

Üç Raylı Kasa Profili TRIPLE RAIL FRAME PROFILE	Profil Kodu Profile Code	(kg/mt) Weight	Jx cm <sup>4</sup>	Jy cm <sup>4</sup>
	2818-2704-2701	2,721	210,04	22,02

\*\* Her profil için minimum sipariş 300 kg'dır.  
\*\* Minimum order quantity is 300 kg per profile.

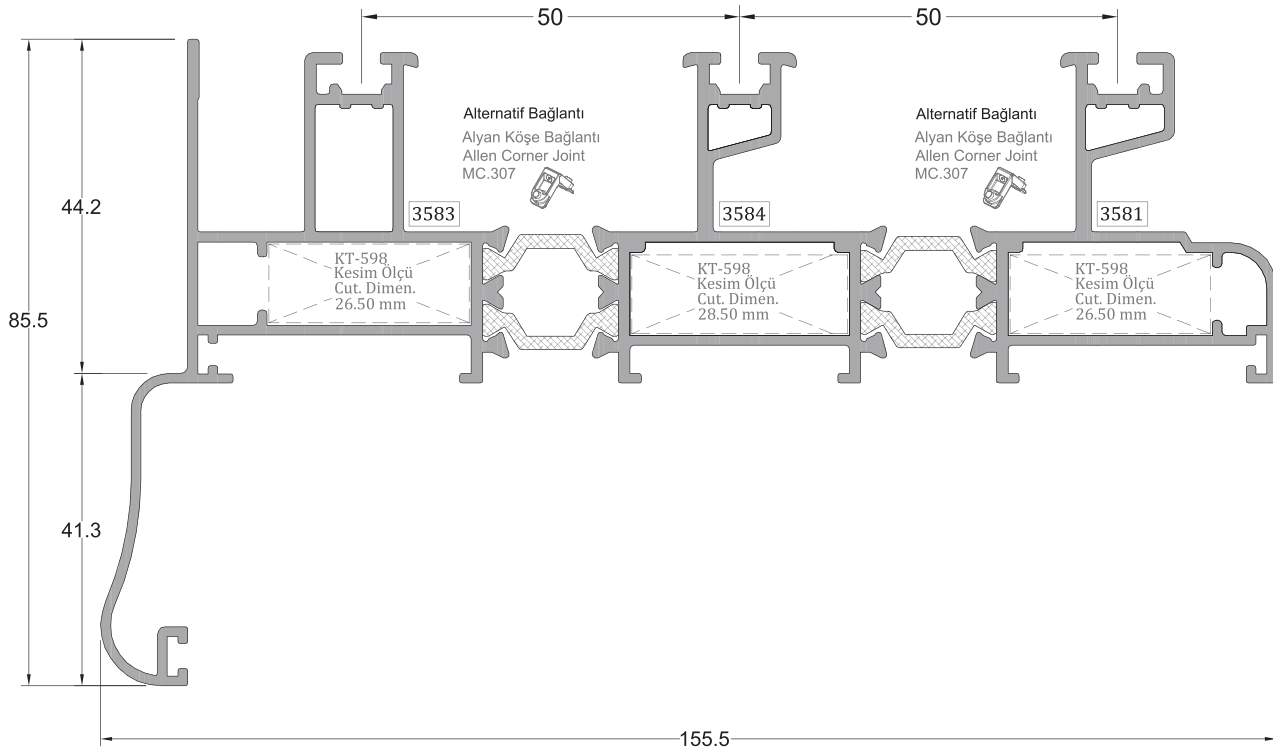

Üç Raylı Kasa Profili TRIPLE RAIL FRAME PROFILE	Profil Kodu Profile Code	(kg/mt) Weight	Jx cm <sup>4</sup>	Jy cm <sup>4</sup>
	3583-3584-3581	2,662	228,73	30,78

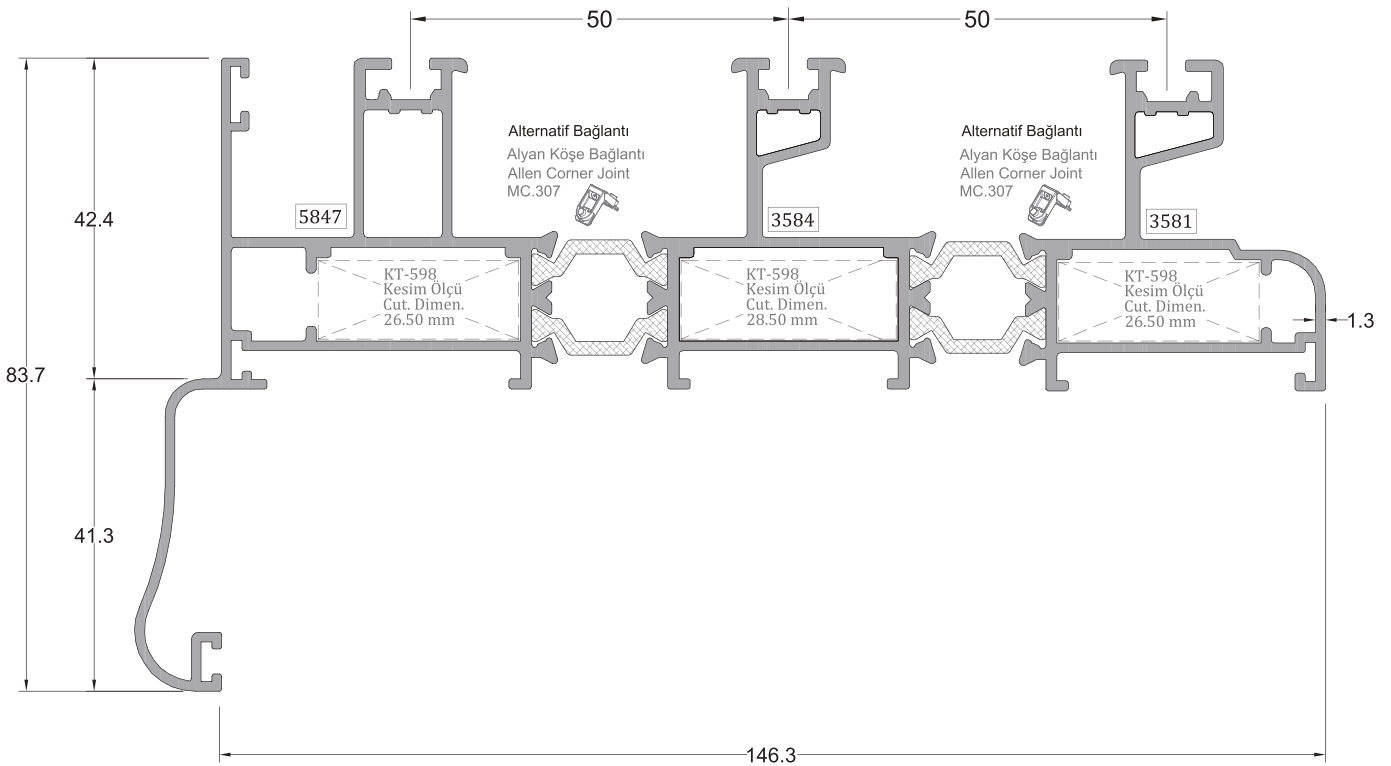

Üç Raylı Kasa Profili TRIPLE RAIL FRAME PROFILE	Profil Kodu Profile Code	(kg/mt) Weight	Jx cm <sup>4</sup>	Jy cm <sup>4</sup>
	5847-3584-3581	2,946	223,49	30,28

\*\* Her profil için minimum sipariş 300 kg'dır.  
\*\* Minimum order quantity is 300 kg per profile.

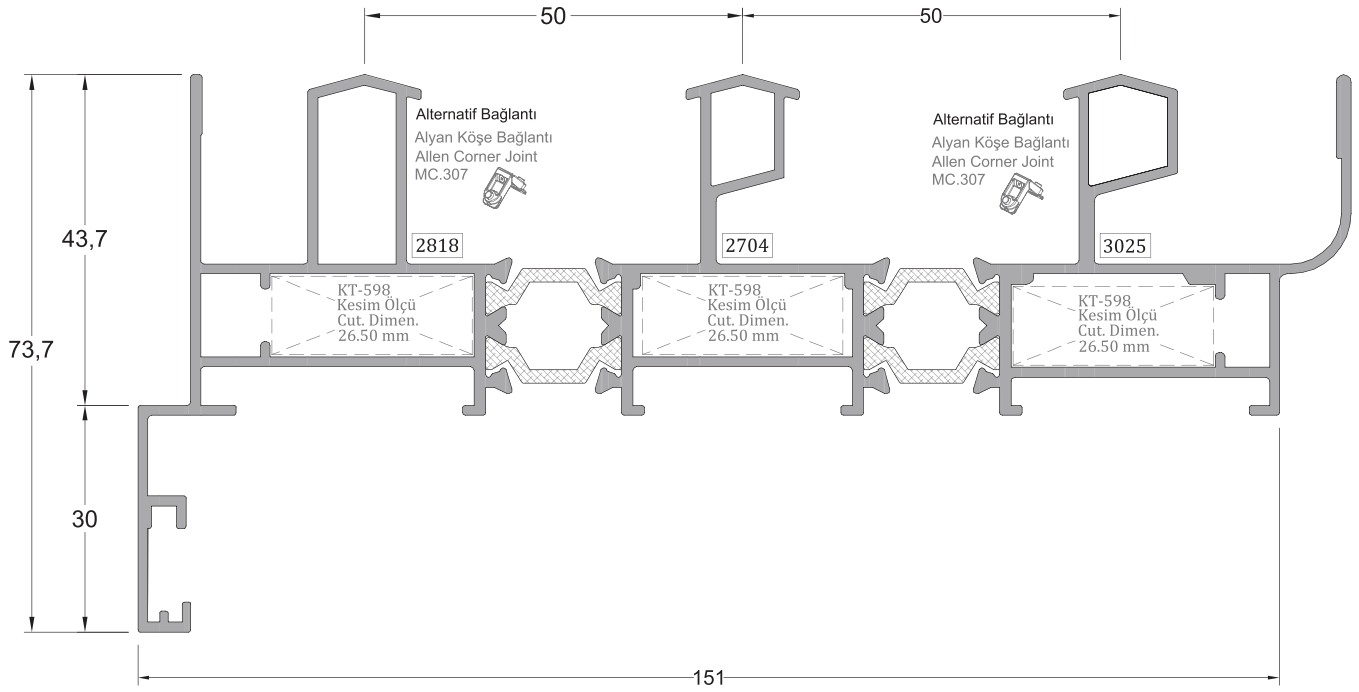

Üç Raylı Sineklikli Kasa Profili TRIPLE RAIL SCREENING FRAME PROFILE	Profil Kodu Profile Code	(kg/mt) Weight	Jx cm <sup>4</sup>	Jy cm <sup>4</sup>
		2818-2704-3025	2,898	249,90

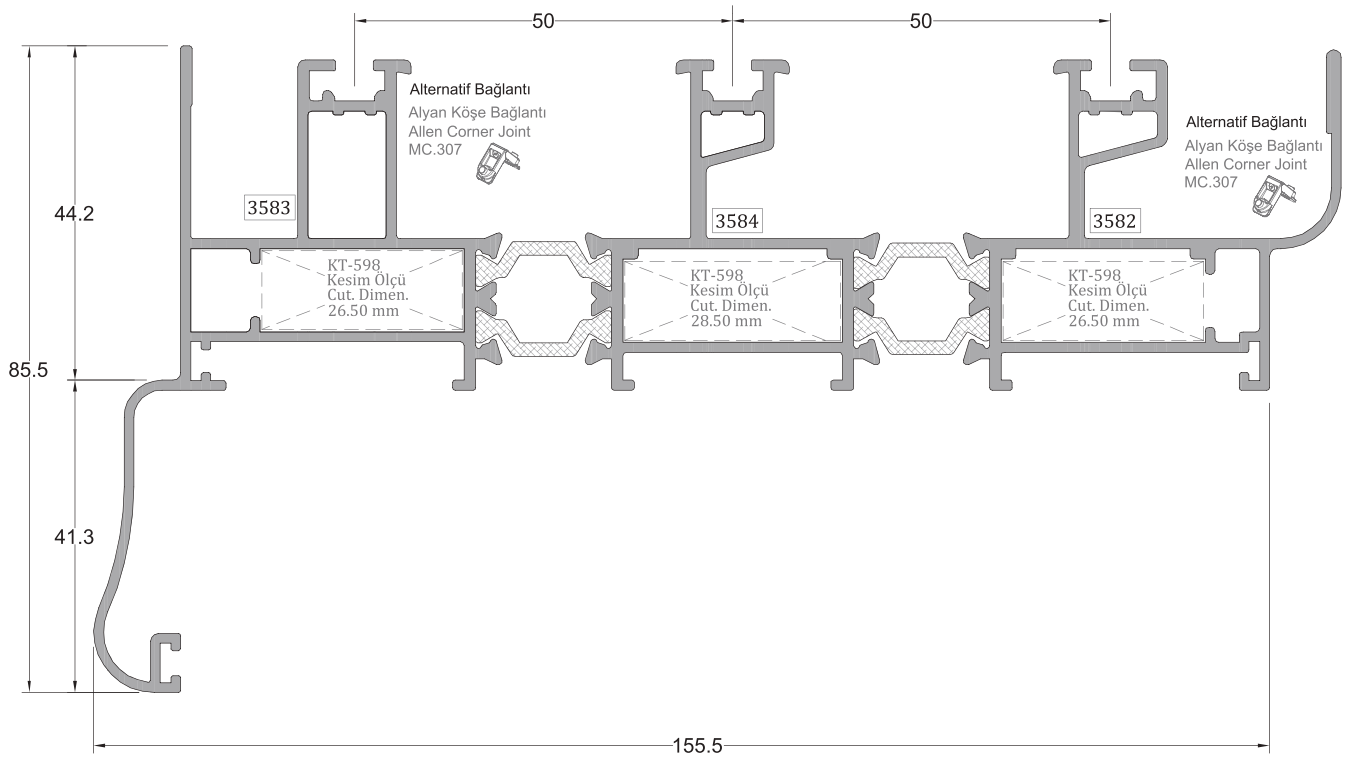

Üç Raylı Sineklikli Kasa Profili TRIPLE RAIL SCREENING FRAME PROFILE	Profil Kodu Profile Code	(kg/mt) Weight	Jx cm <sup>4</sup>	Jy cm <sup>4</sup>
		3583-3584-3582	3,047	268,33

\*\* Her profil için minimum sipariş 300 kg'dır.  
\*\* Minimum order quantity is 300 kg per profile.

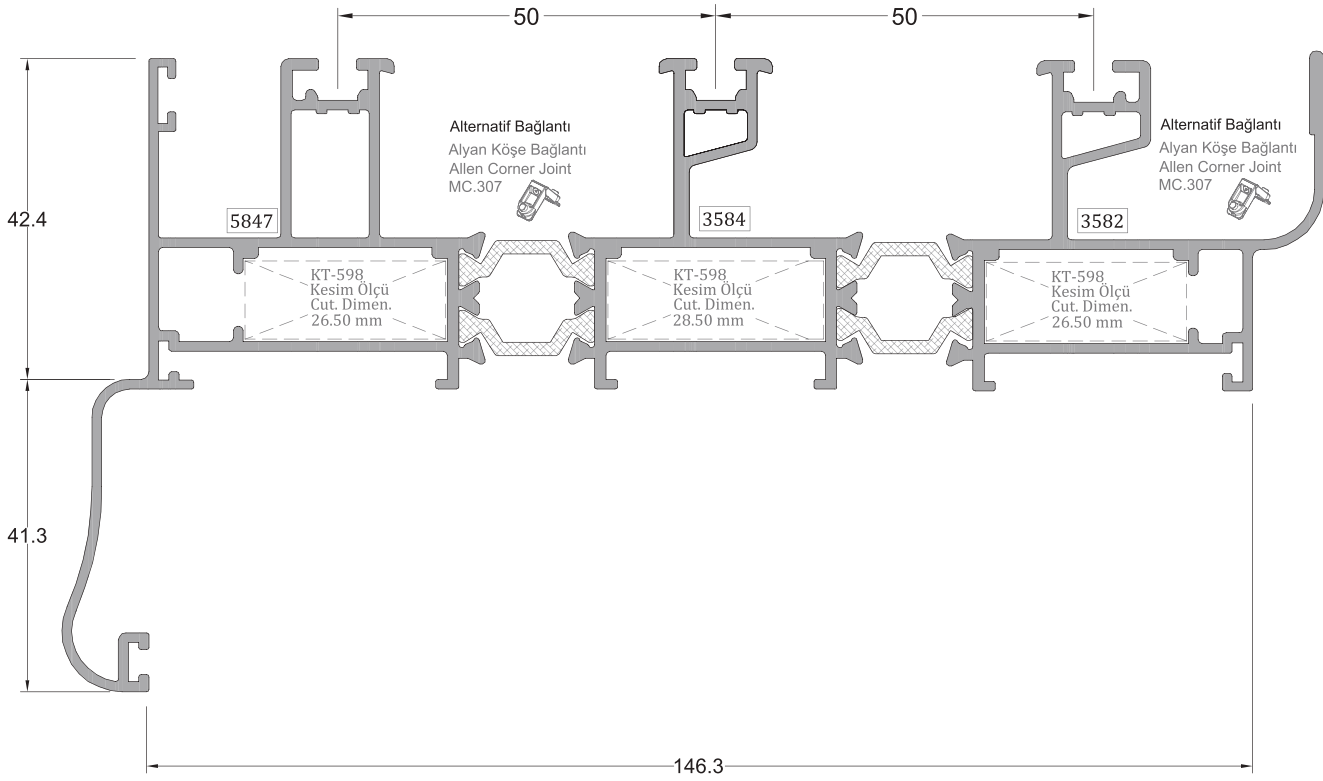

Üç Raylı Sineklikli Kasa Profili TRIPLE RAIL SCREENING FRAME PROFILE	Profil Kodu Profile Code	(kg/mt) Weight	Jx cm <sup>4</sup>	Jy cm <sup>4</sup>
	5847-3584-3582	3,098	265,54	31,64

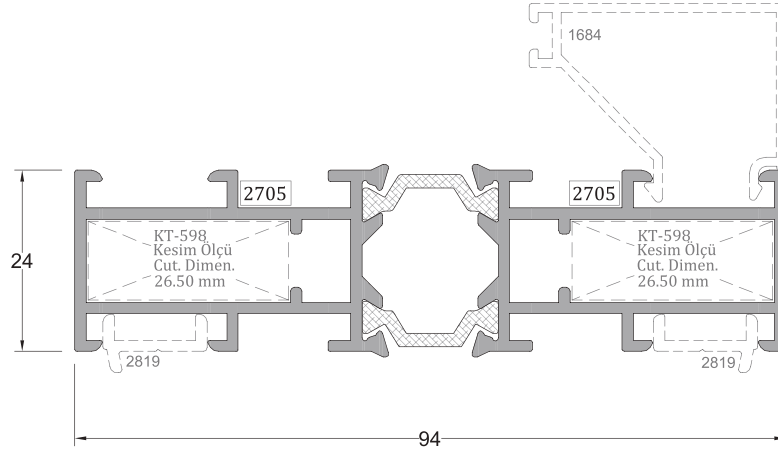

Sabit Kasa Profili FIXED FRAME PROFILE	Profil Kodu Profile Code	(kg/mt) Weight
	2705-2705	1,485

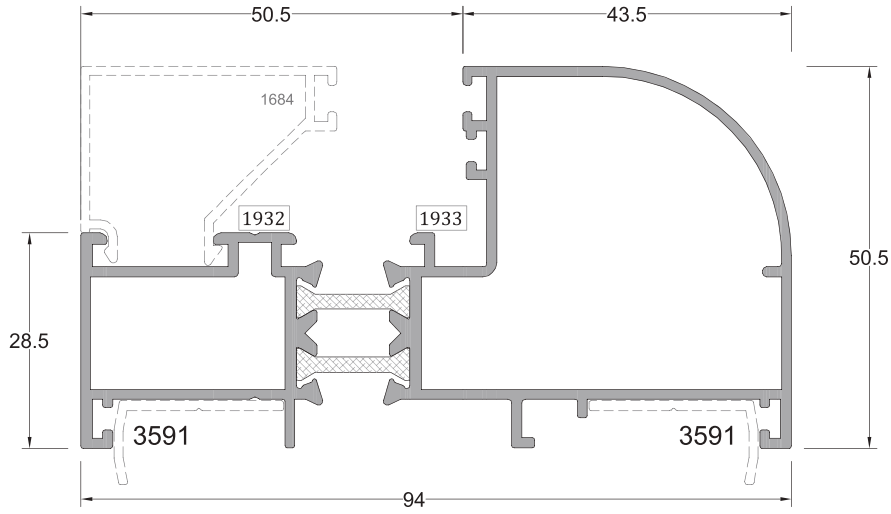

Sabit Kasa Profili FIXED FRAME PROFILE	Profil Kodu Profile Code	(kg/mt) Weight
	1932-1933	1,478

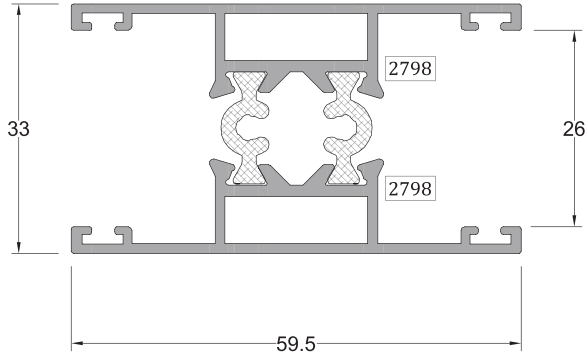

Kanat İçi Orta Kayıt Profili SASH INTERNAL MULLION PROFILE	Profil Kodu Profile Code	(kg/mt) Weight
	2798-2798	1,021

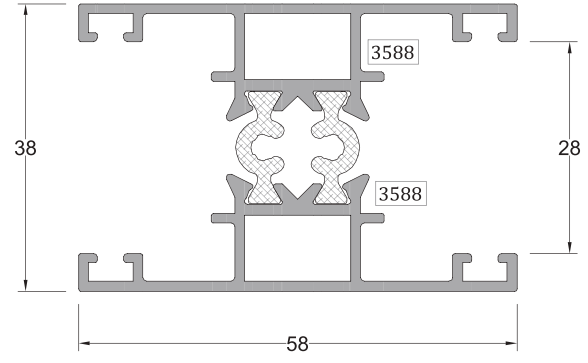

Kanat İçi Orta Kayıt Profili SASH INTERNAL MULLION PROFILE	Profil Kodu Profile Code	(kg/mt) Weight
	3588-3588	1,134

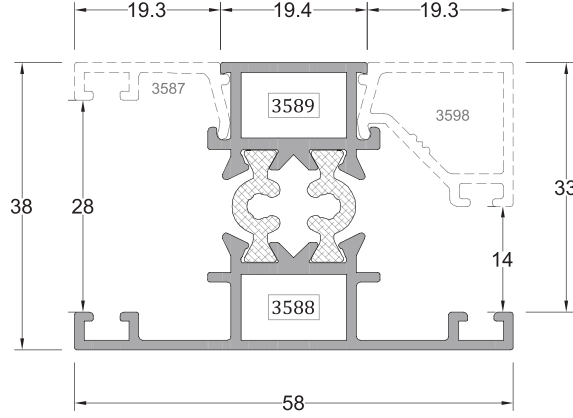

Orta Kayıt Profili MULLION PROFILE	Profil Kodu Profile Code	(kg/mt) Weight
	3588-3589	0,942

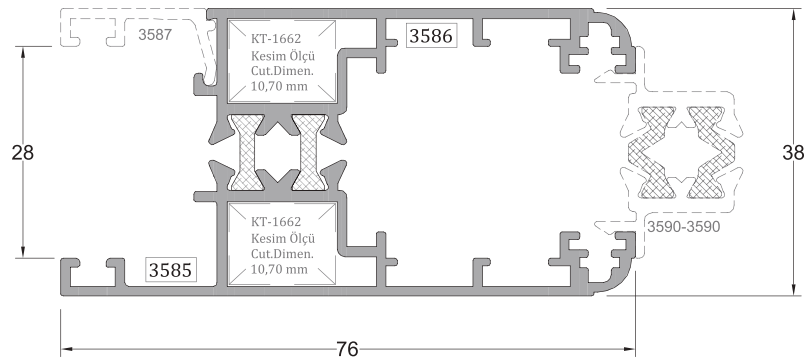

Kanat Profili SASH PROFILE	Profil Kodu Profile Code	(kg/mt) Weight	Jx cm <sup>4</sup>	Jy cm <sup>4</sup>
	3585-3586	1,289	18,10	8,98

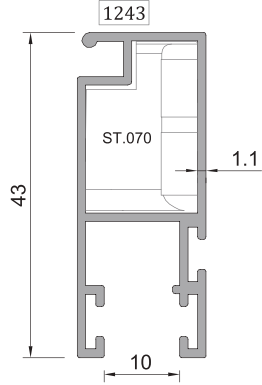

Sineklik Profili	Profil Kodu	(kg/mt)
SCREENING PROFILE	Profile Code	Weight
	1243	0,434

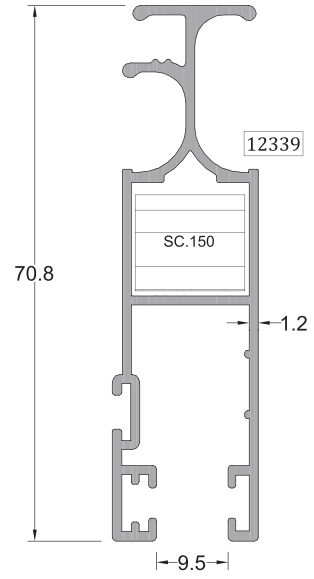

Sineklik Profili	Profil Kodu	(kg/mt)
SCREENING PROFILE	Profile Code	Weight
	12339	0,703

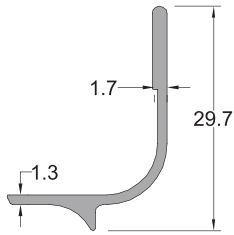

Sineklik Ray Profili	Profil Kodu	(kg/mt)
SCREENING RAIL PROFILE	Profile Code	Weight
	2707	0,190

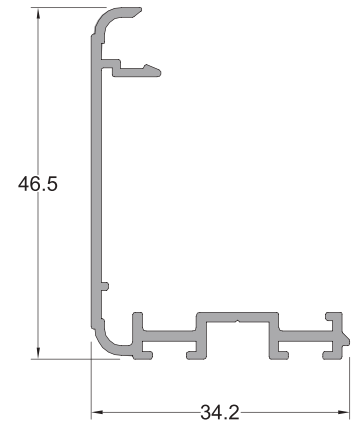

Kenet Profili	Profil Kodu	(kg/mt)
INTERLOCK PROFILE	Profile Code	Weight
	2703	0,403

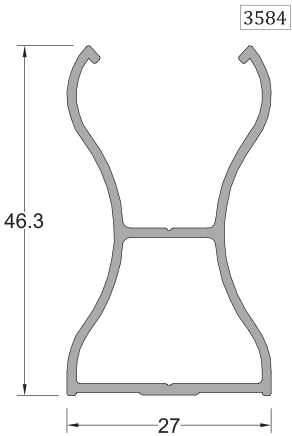

Takviye Profili	Profil Kodu	(kg/mt)
REINFORCE PROFILE	Profile Code	Weight
	3594	0,456

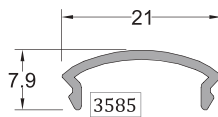

Takviye Kapak Profili	Profil Kodu	(kg/mt)
REINFORCE COVER PROFILE	Profile Code	Weight
	3585	0,101

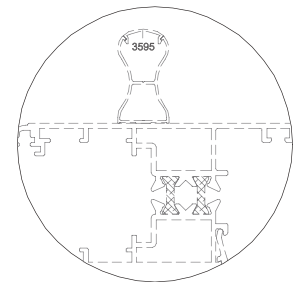

\*\* Her profil için minimum sipariş 300 kg'dır.  
\*\* Minimum order quantity is 300 kg per profile.

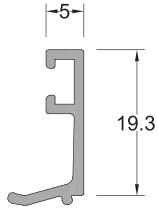

Çıta Profili BEAD PROFILE	Profil Kodu Profile Code	(kg/mt) Weight
	3587	0,140

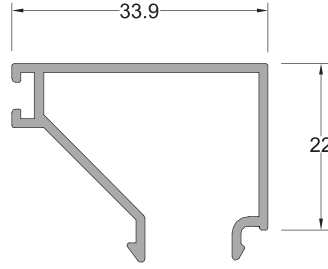

Çıta Profili BEAD PROFILE	Profil Kodu Profile Code	(kg/mt) Weight
	1684	0,325

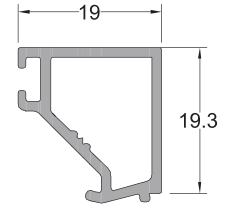

Çıta Profili BEAD PROFILE	Profil Kodu Profile Code	(kg/mt) Weight
	3598	0,263

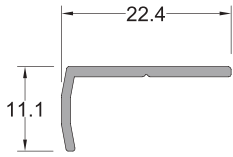

Adaptör Profili ADAPTER PROFILE	Profil Kodu Profile Code	(kg/mt) Weight
	3591	0,112

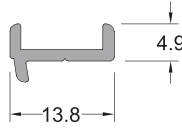

Adaptör Profili ADAPTER PROFILE	Profil Kodu Profile Code	(kg/mt) Weight
	2819	0,093

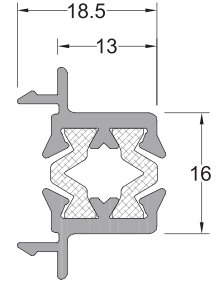

Adaptör Profili ADAPTER PROFILE	Profil Kodu Profile Code	(kg/mt) Weight
	3590-3590	0,454

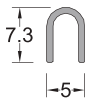

Ray Profili RAIL PROFILE	Profil Kodu Profile Code	(kg/mt) Weight
	6877	0,061



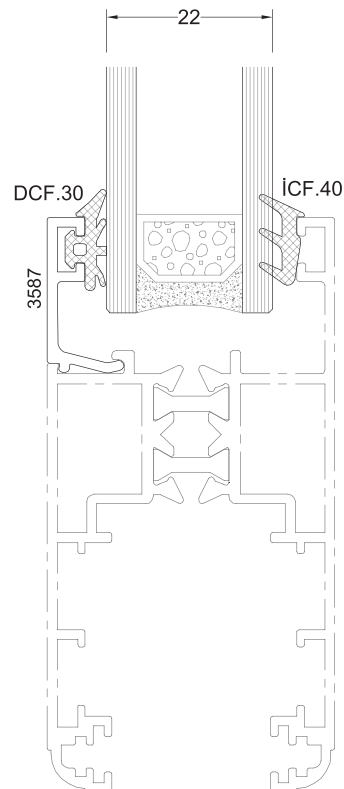
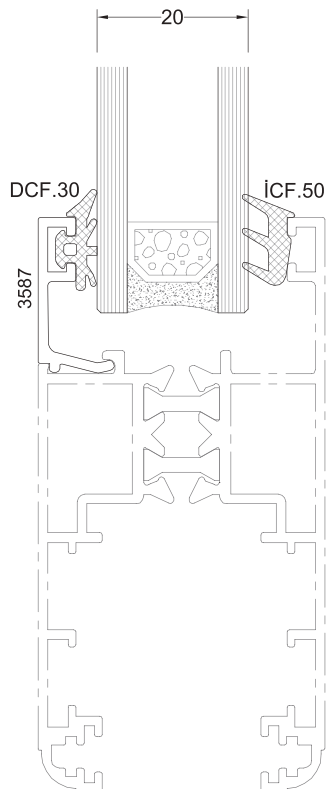
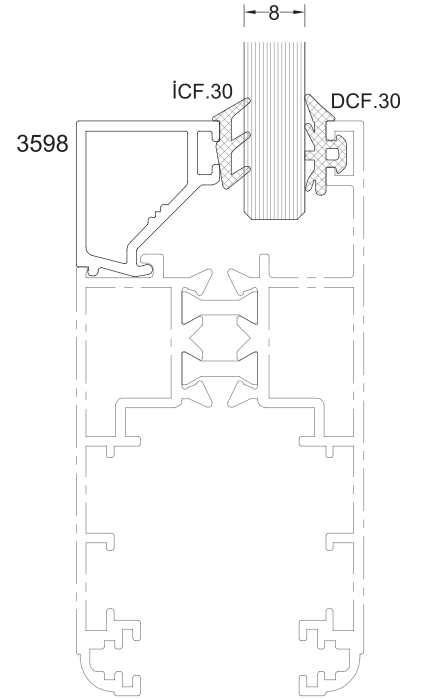
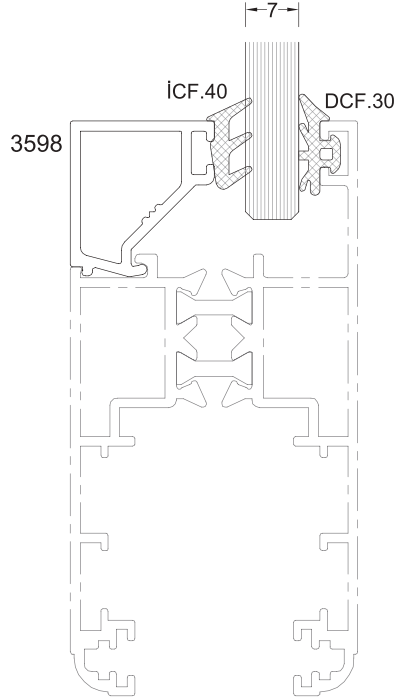
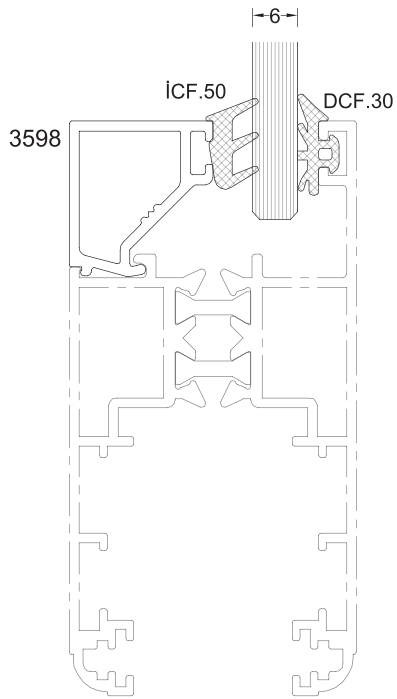

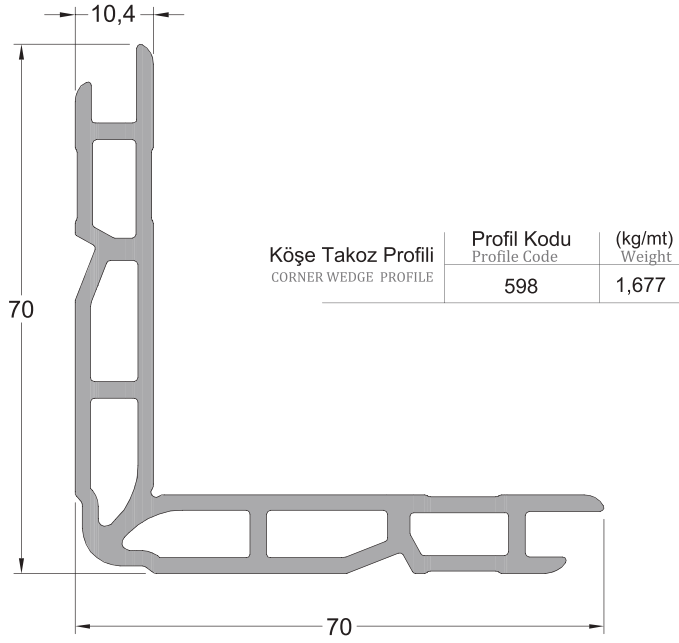

Köşe Takozu Profil Kodu Corner Wedge Profile Code	Kullanıldığı Profil Profile Used	Kesim Boyu (mm) Cutting Length (mm)
598	2705	26,00 mm
	1932	25,20 mm
	1933	47,20 mm

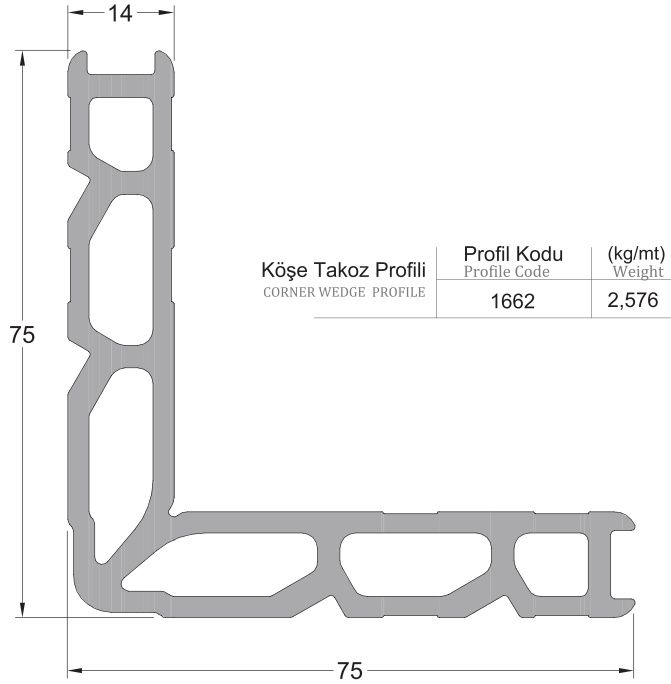

Köşe Takozu Profil Kodu Corner Wedge Profile Code	Kullanıldığı Profil Profile Used	Kesim Boyu (mm) Cutting Length (mm)
1662	3585,3586	10,70 mm

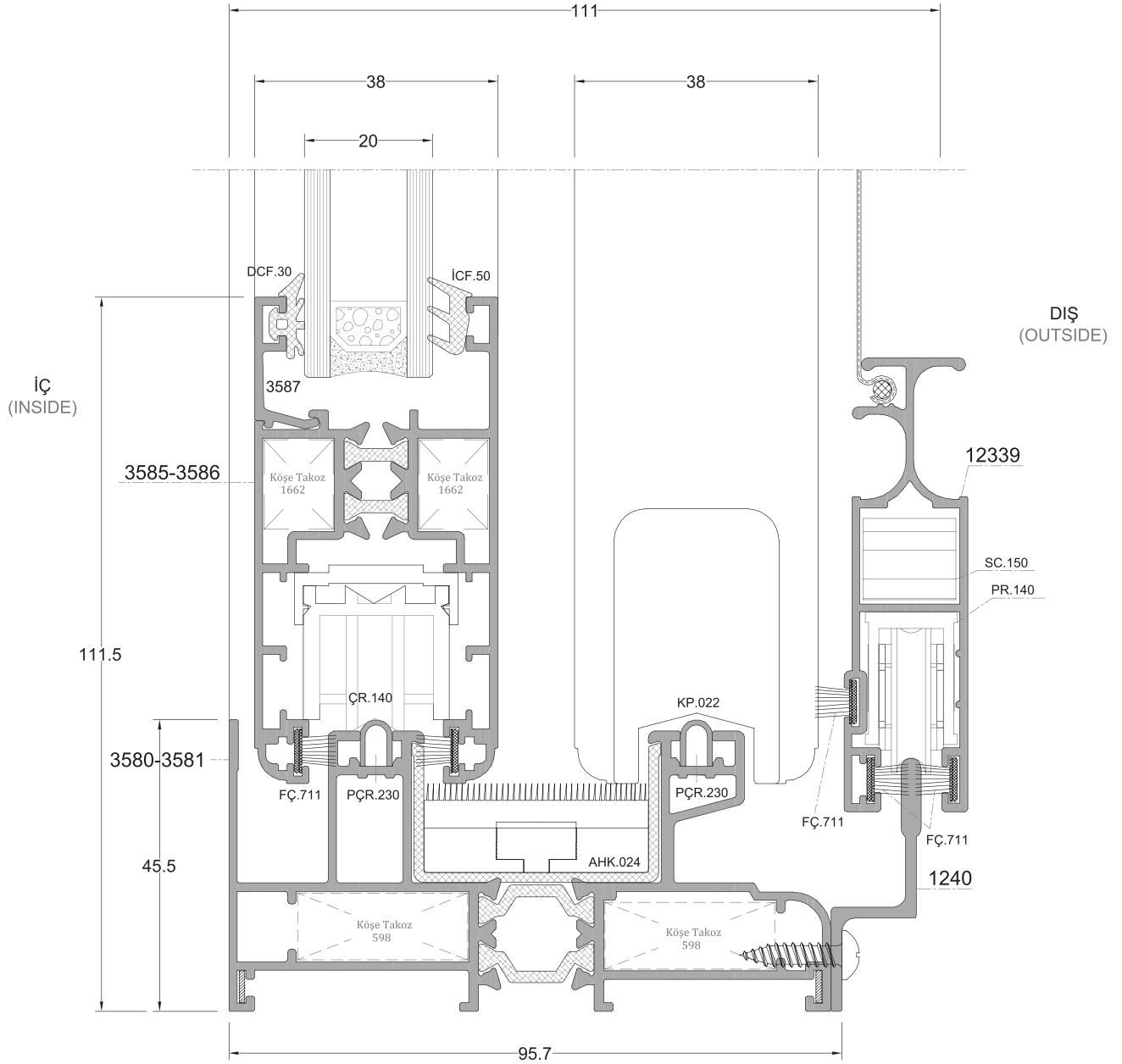
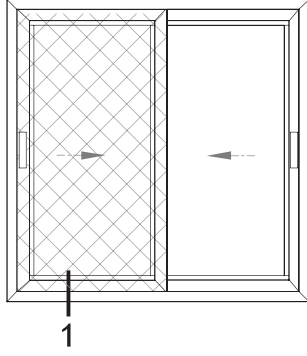

D-1

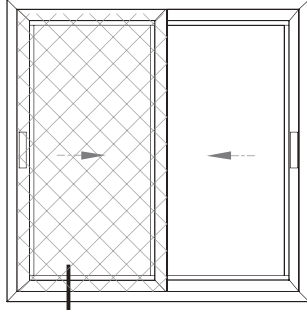

1A

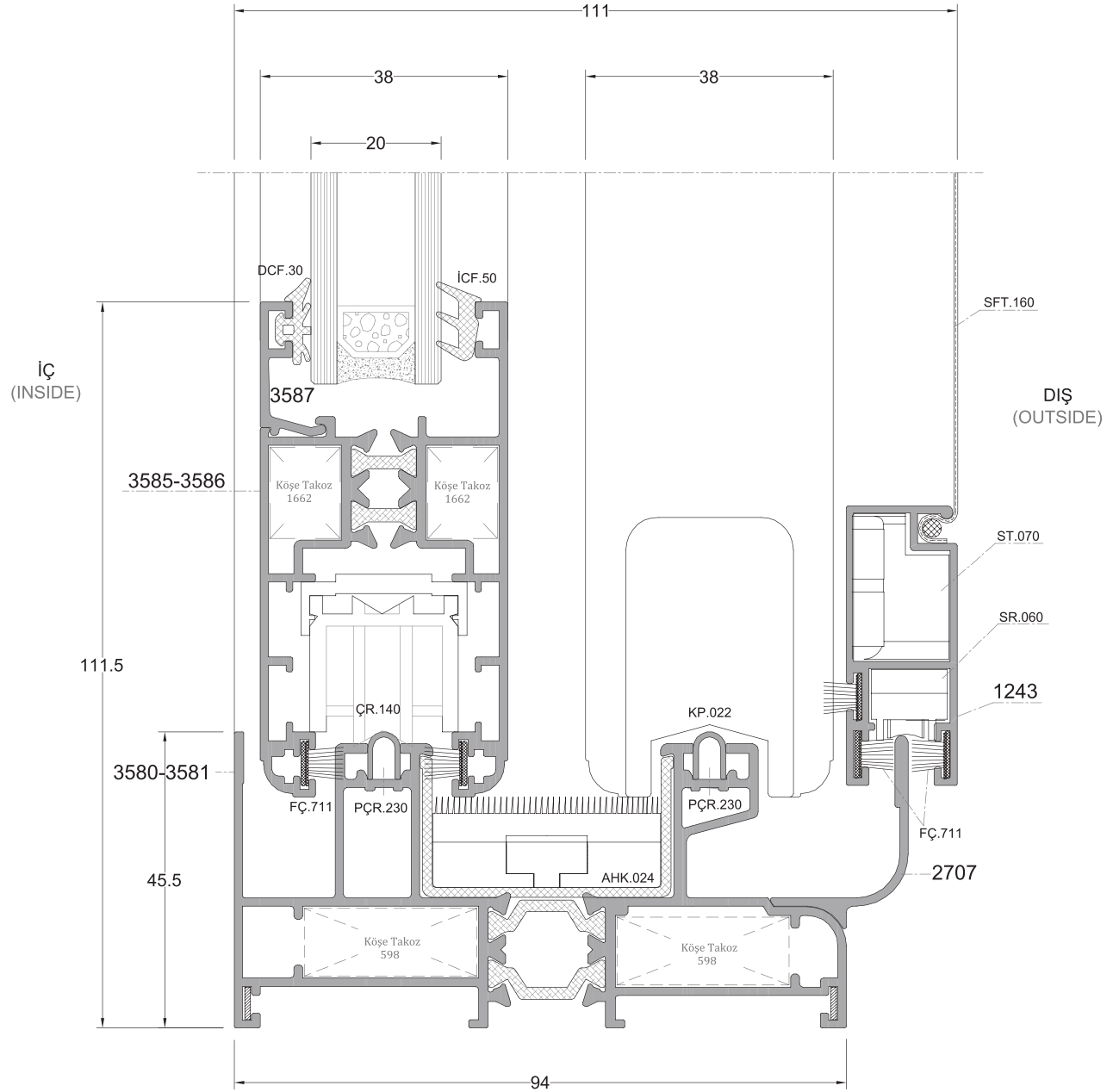

D-1A

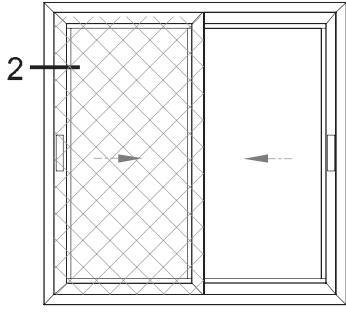

İÇ  
(INSIDE)

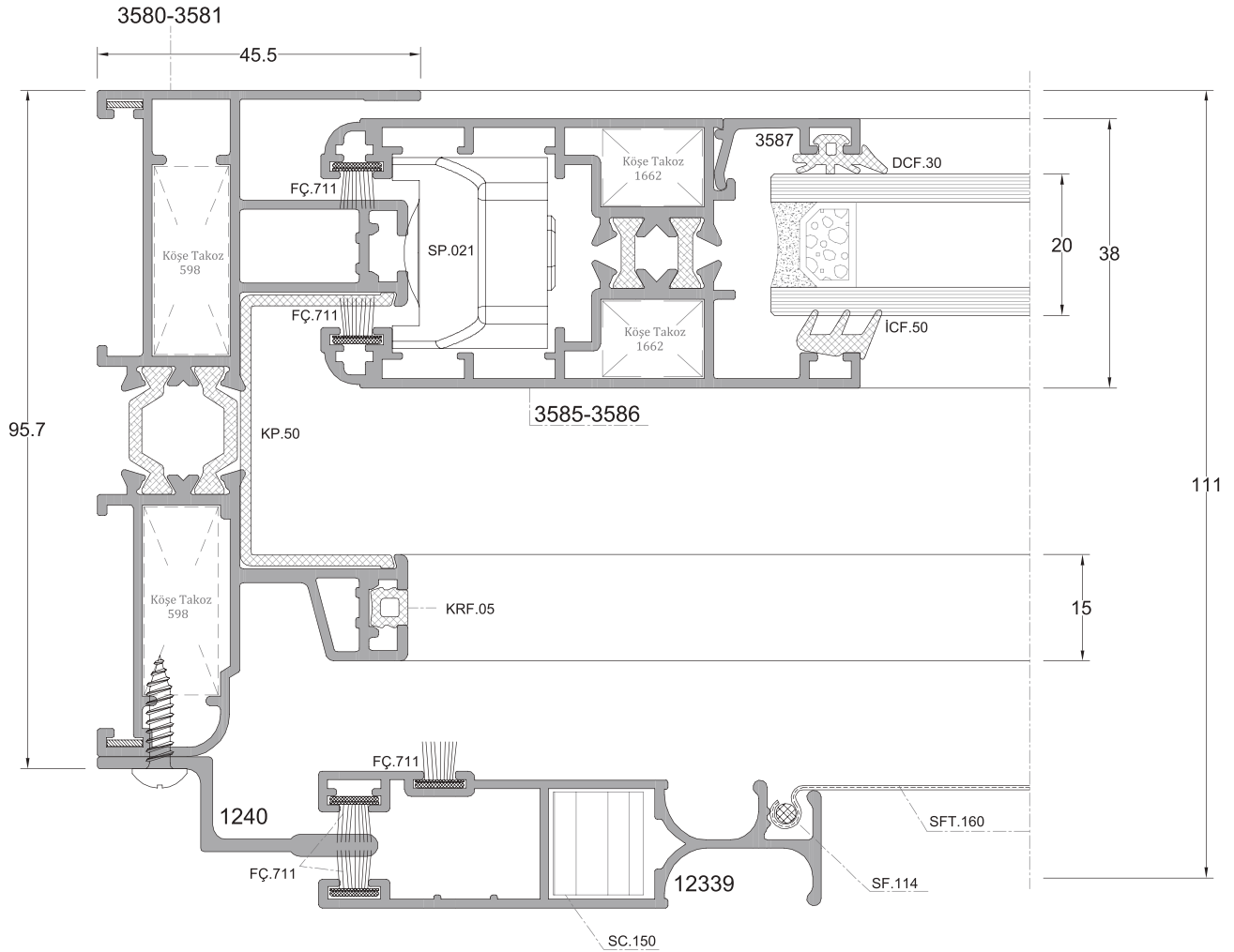

DIŞ  
(OUTSIDE)

D-2

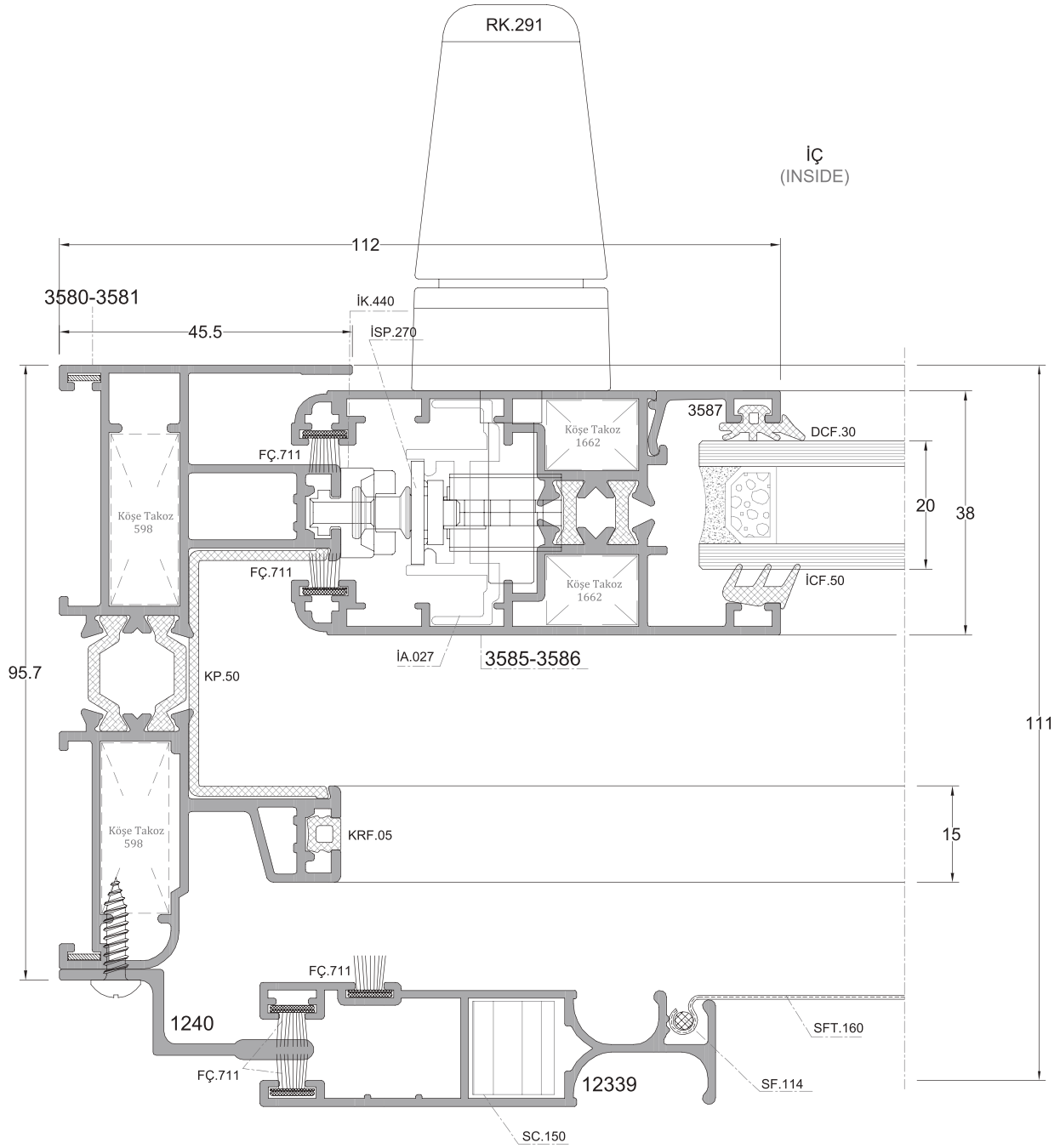
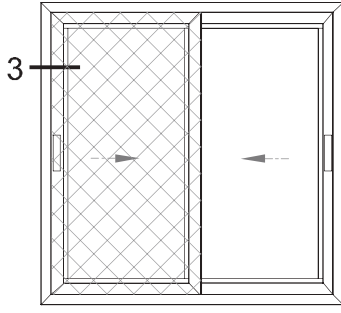

DIŞ  
(OUTSIDE)

D-3

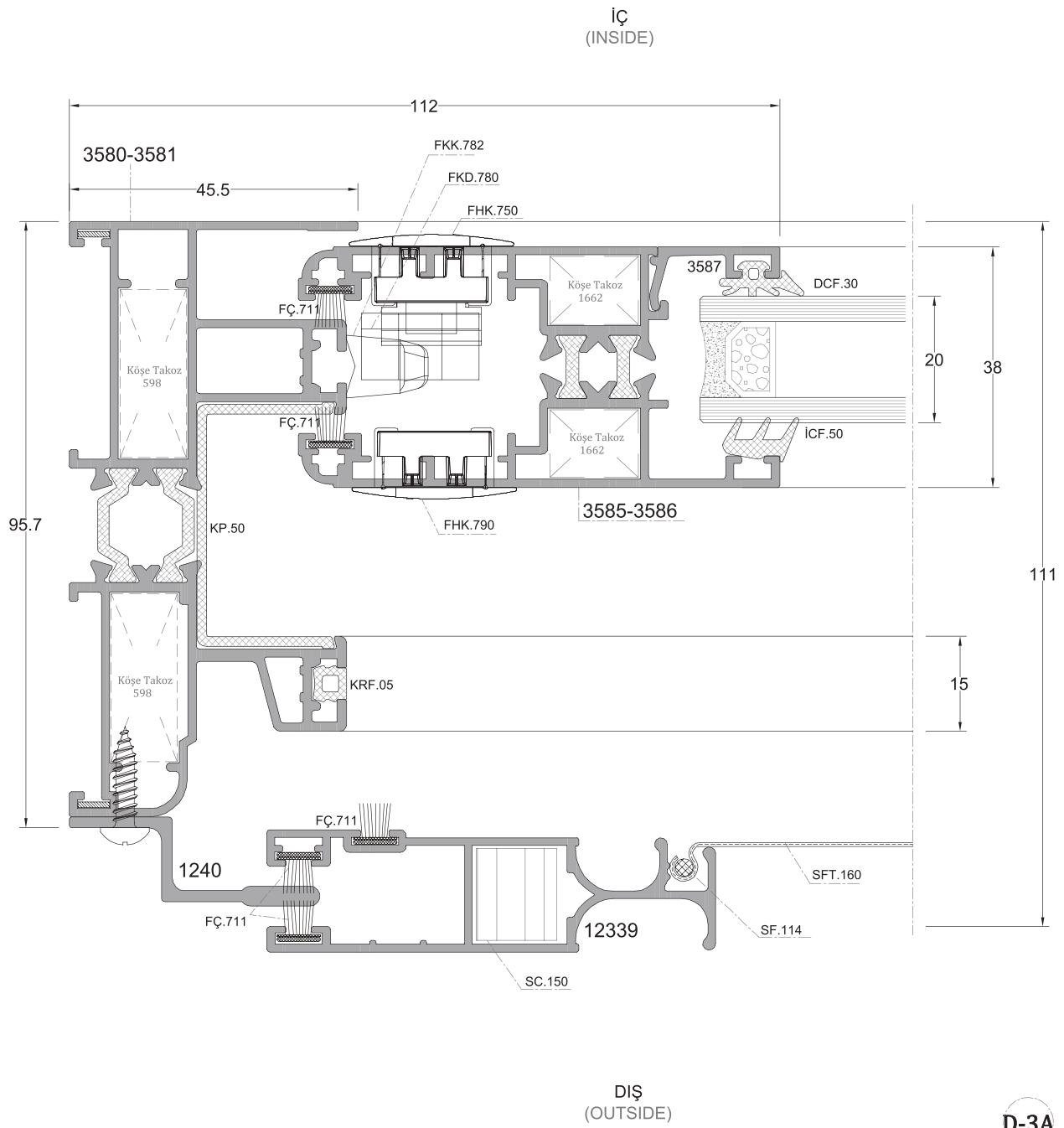
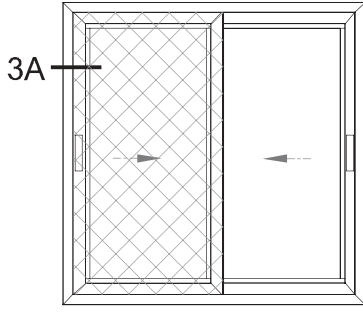

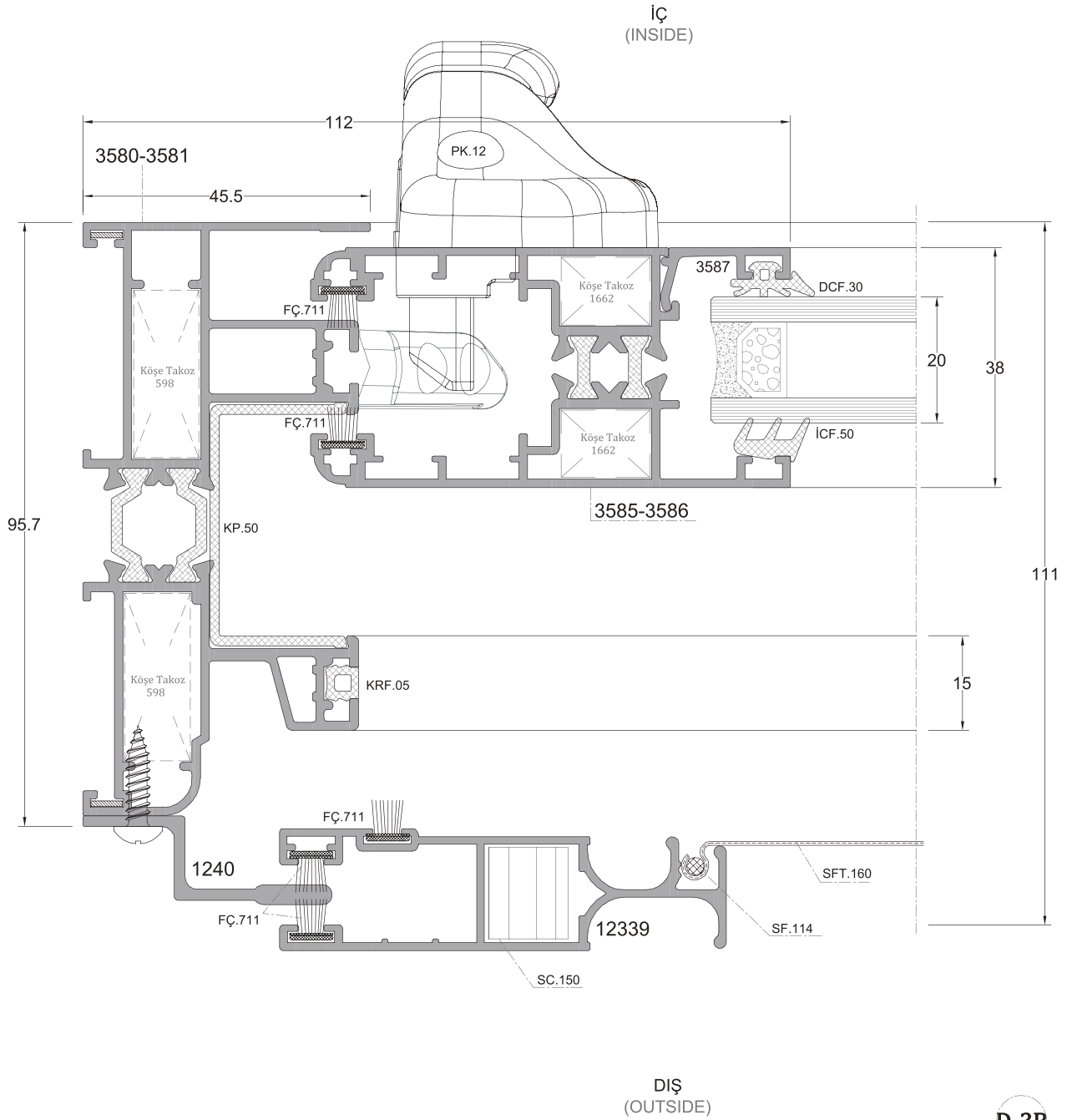
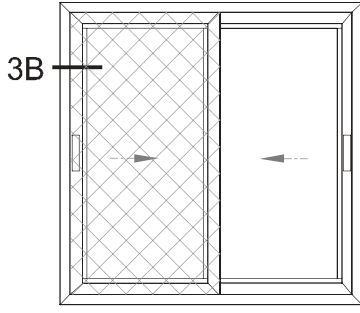



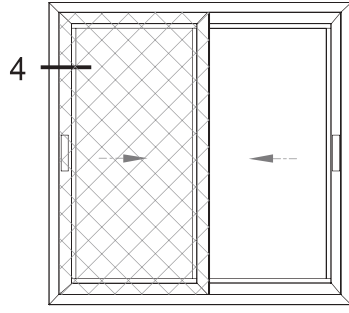

İÇ  
(INSIDE)

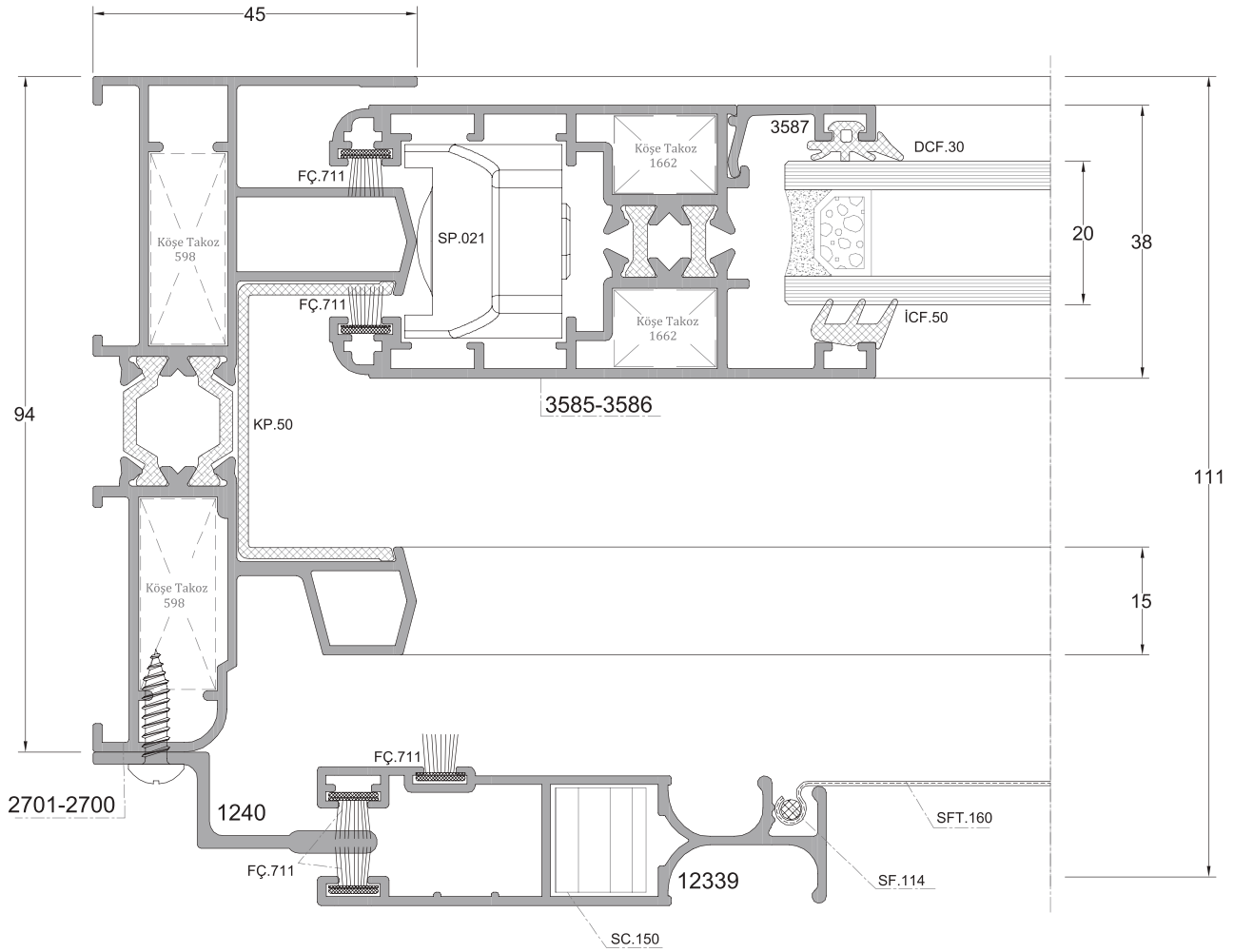

DIŞ  
(OUTSIDE)

D-4

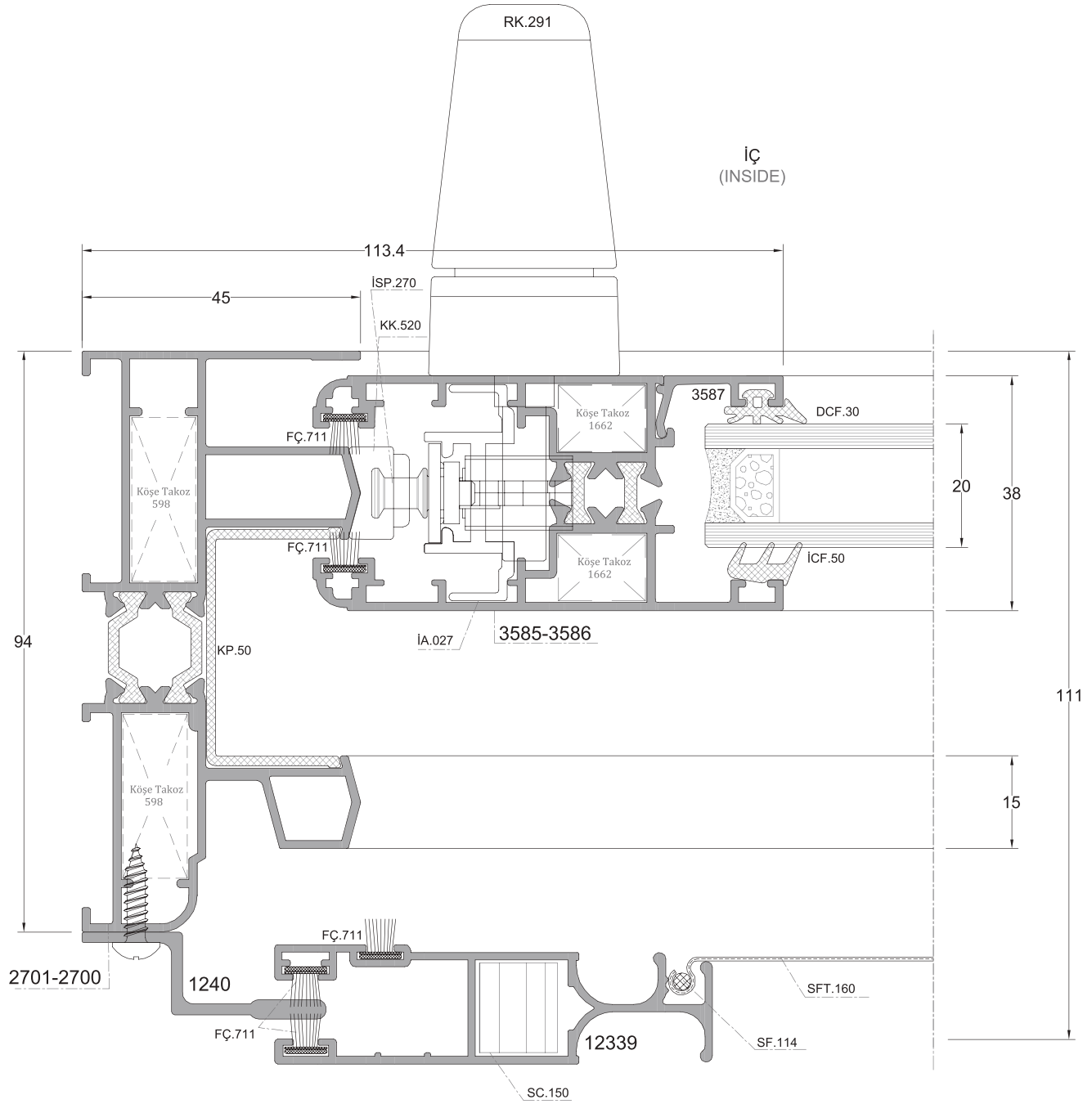
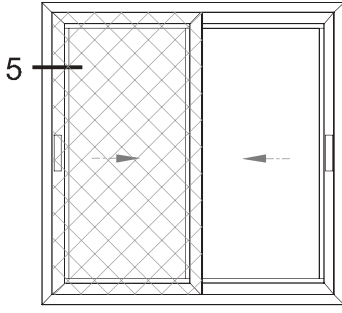

DIŞ  
(OUTSIDE)

D-5

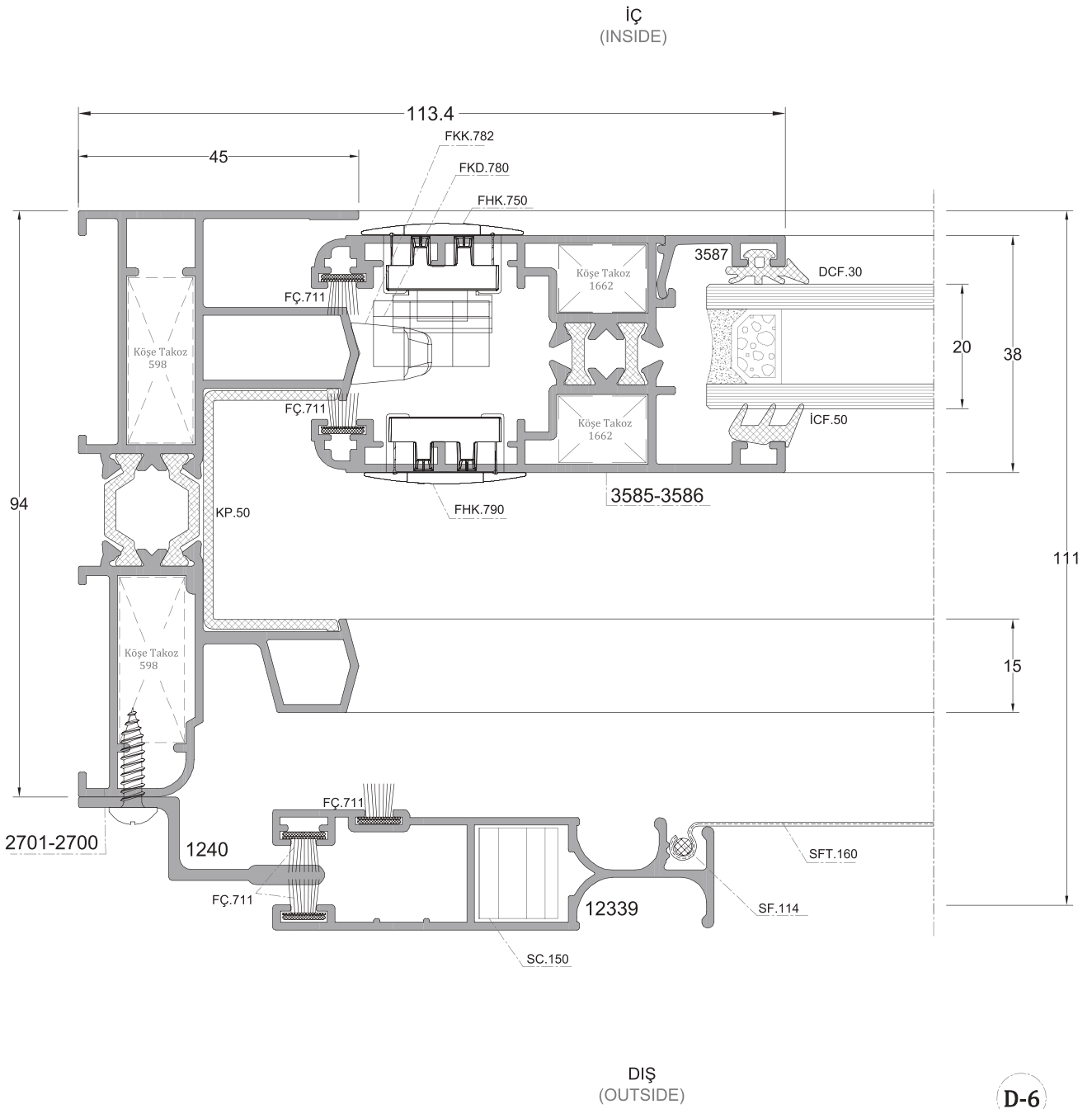
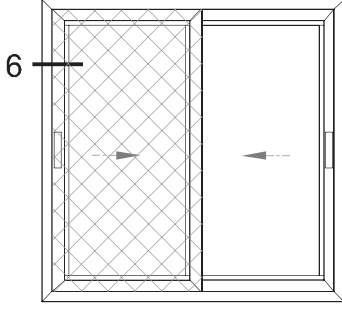

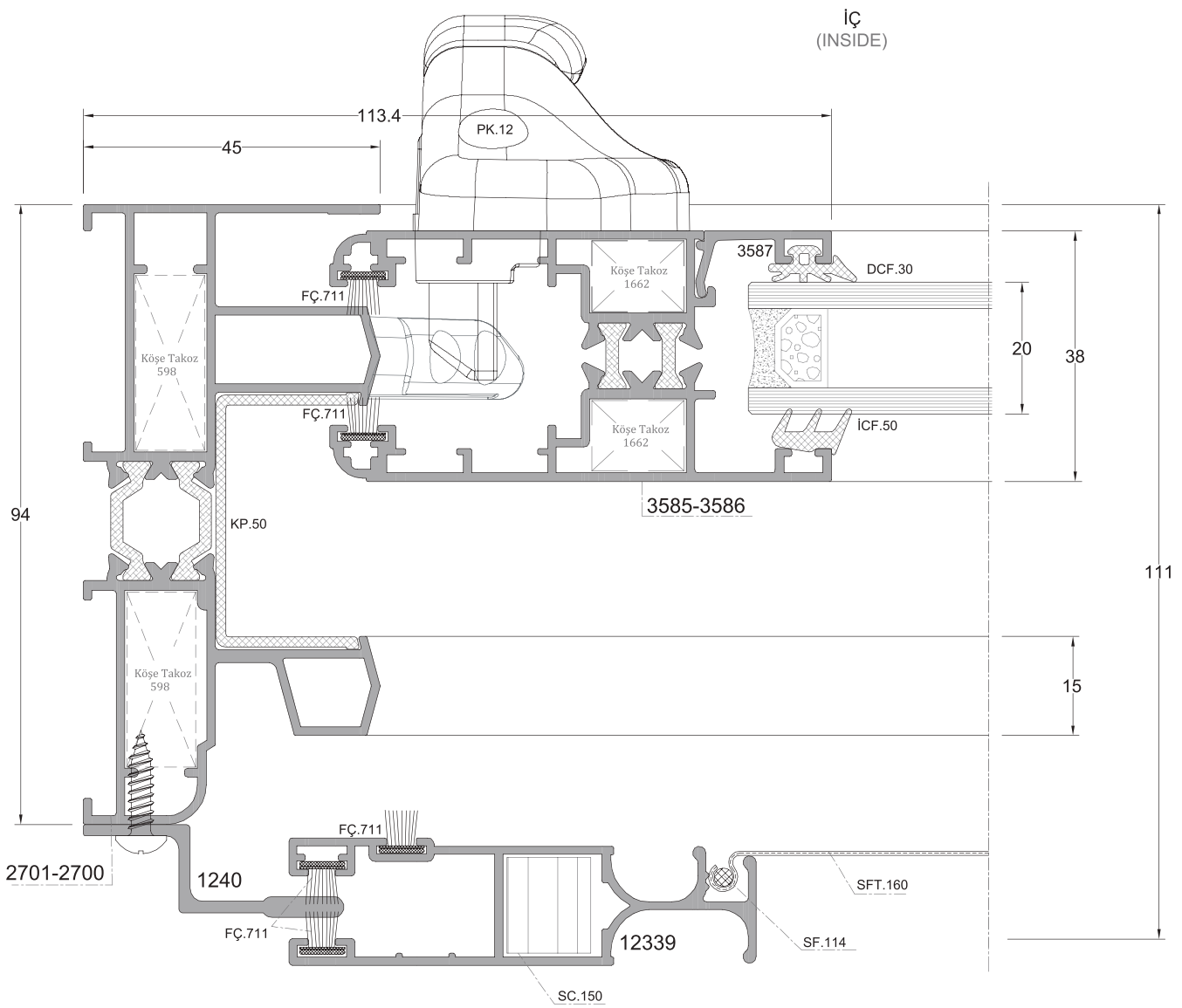
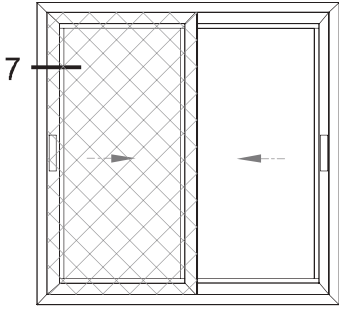

DİŞ  
(OUTSIDE)

D-7

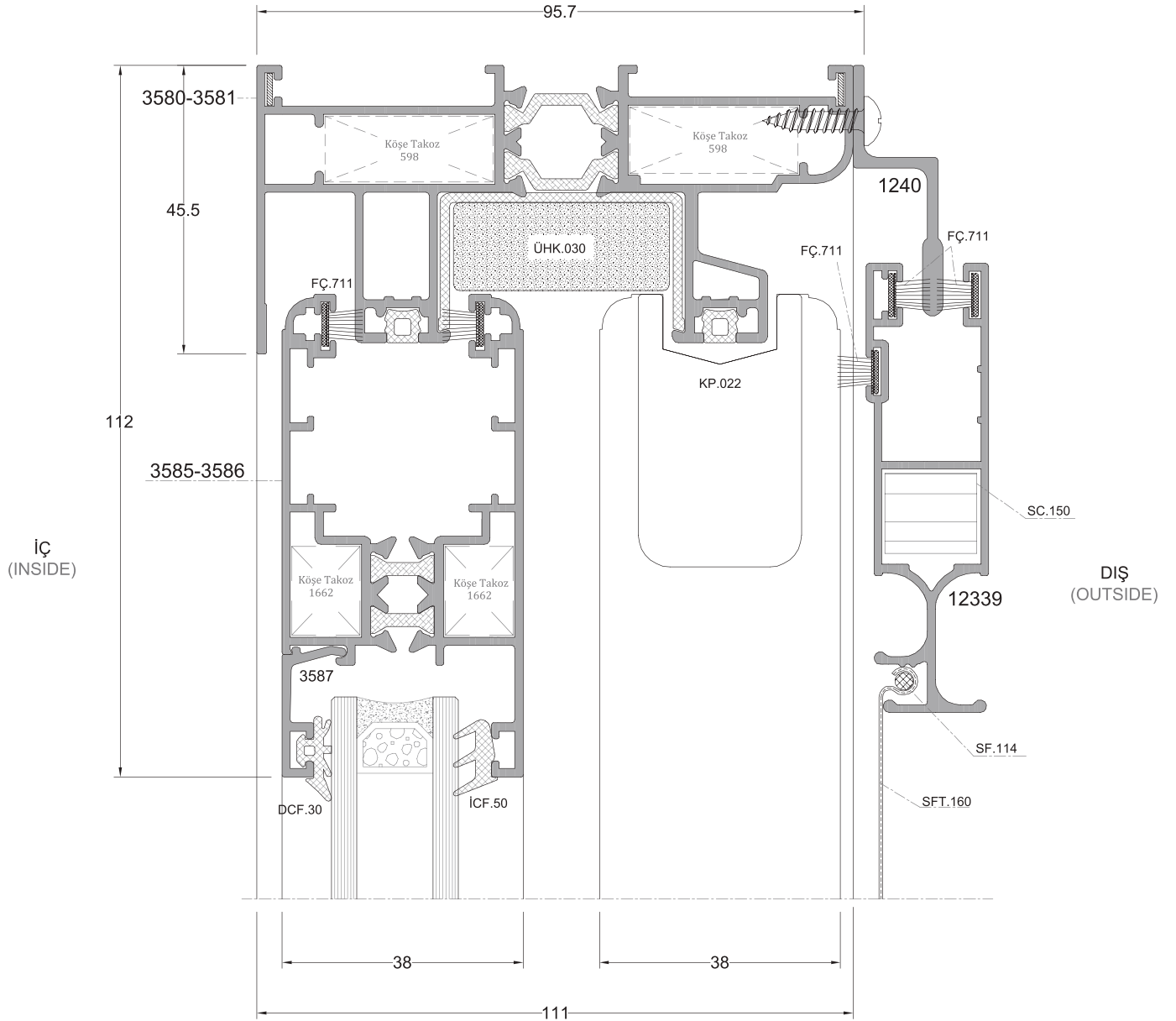
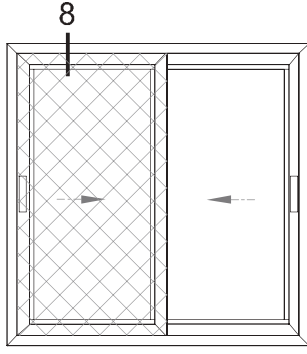

D-8

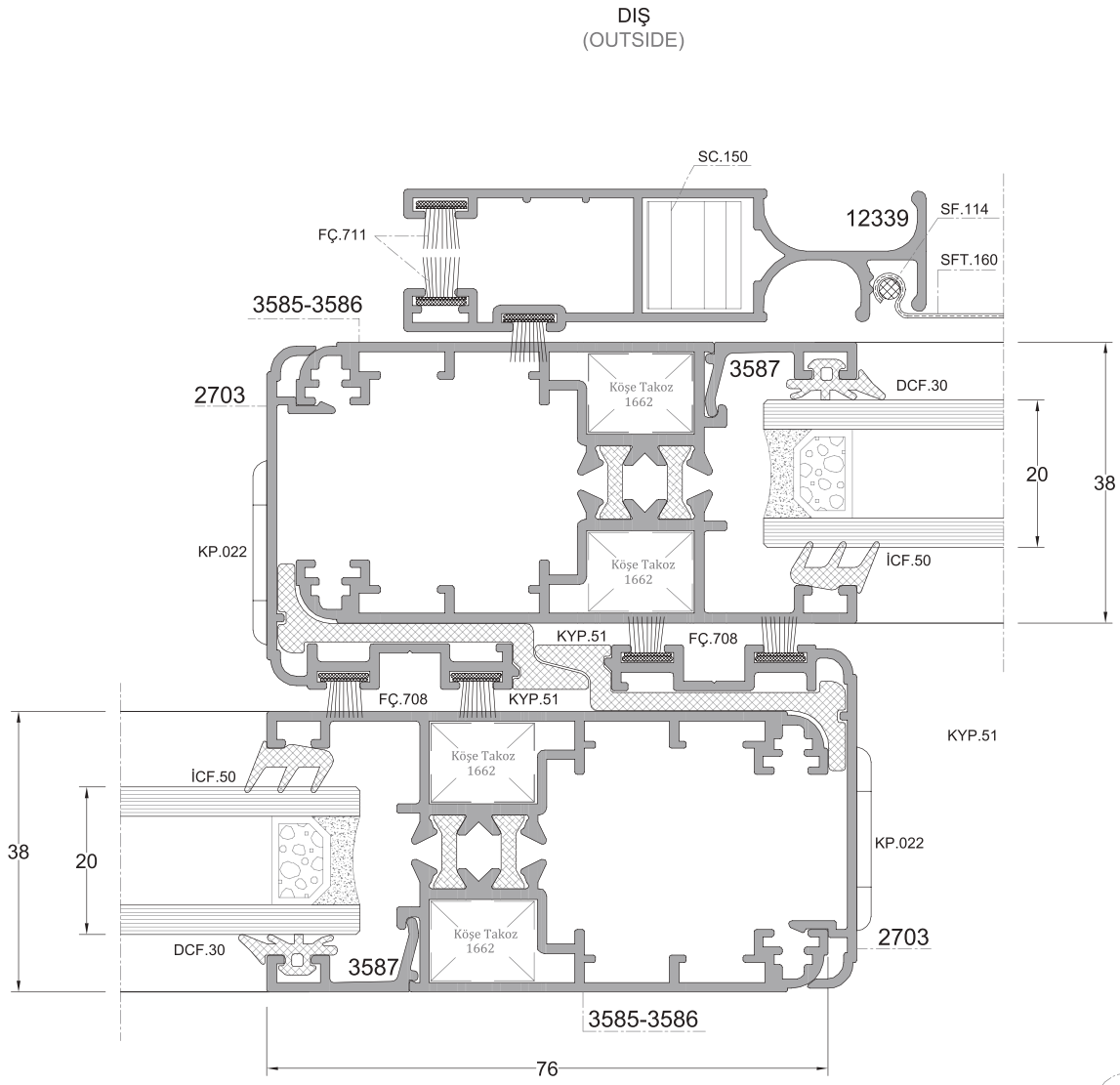
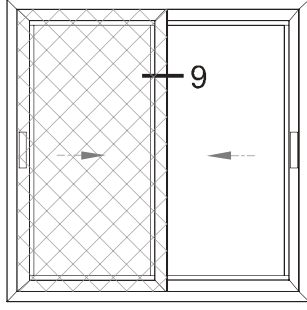

D-9

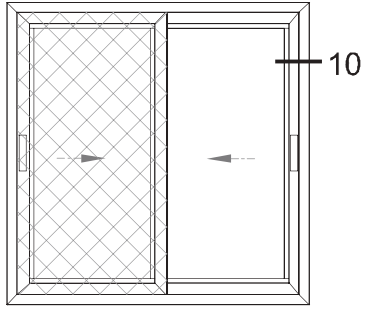

D-10

İÇ  
(INSIDE)

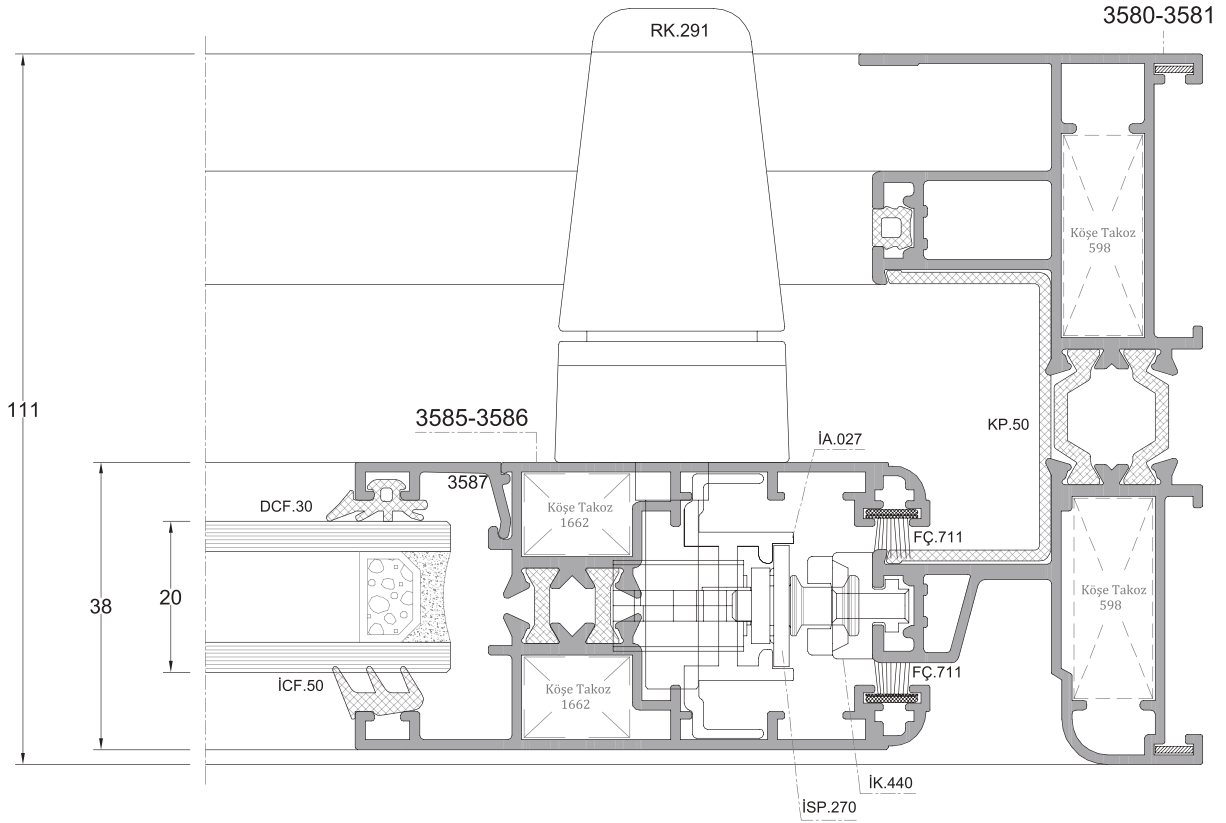

DIŞ  
(OUTSIDE)

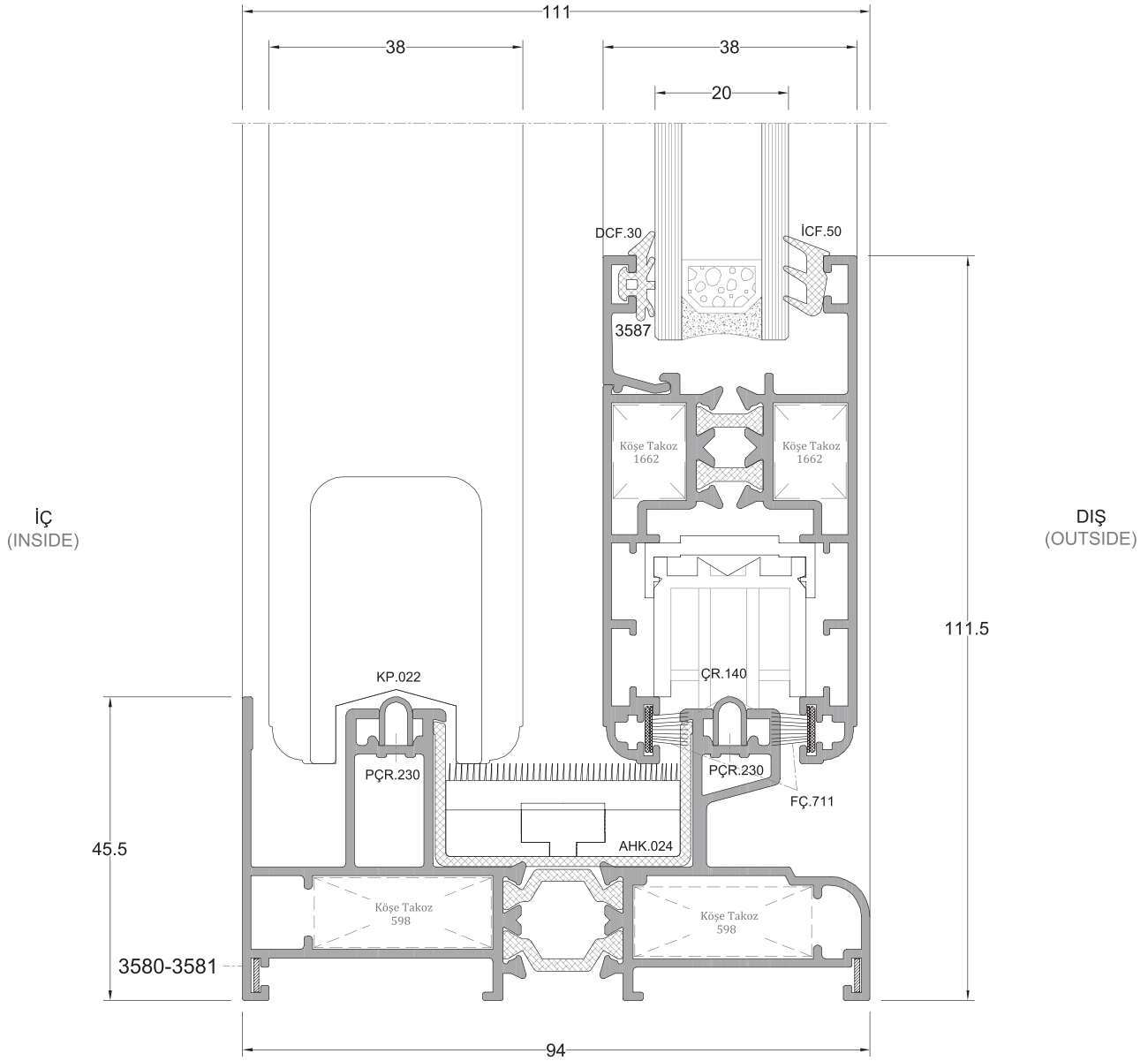
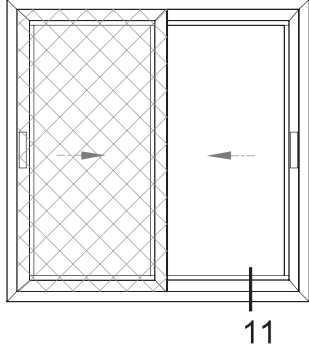



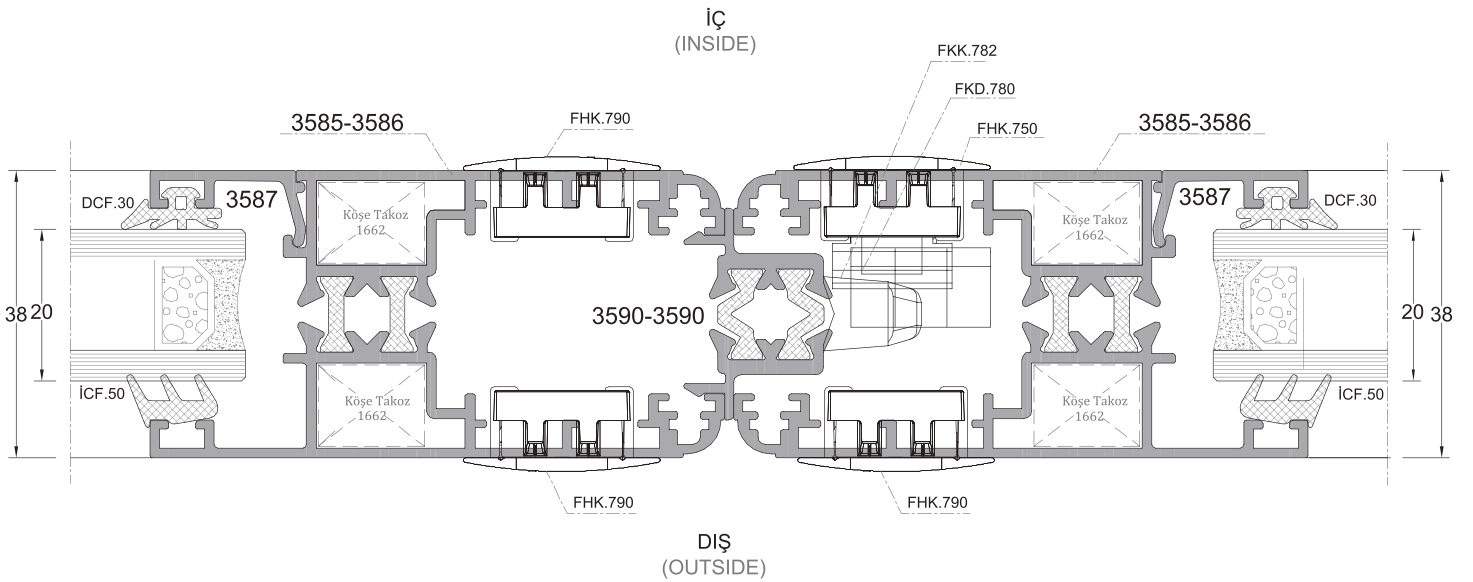
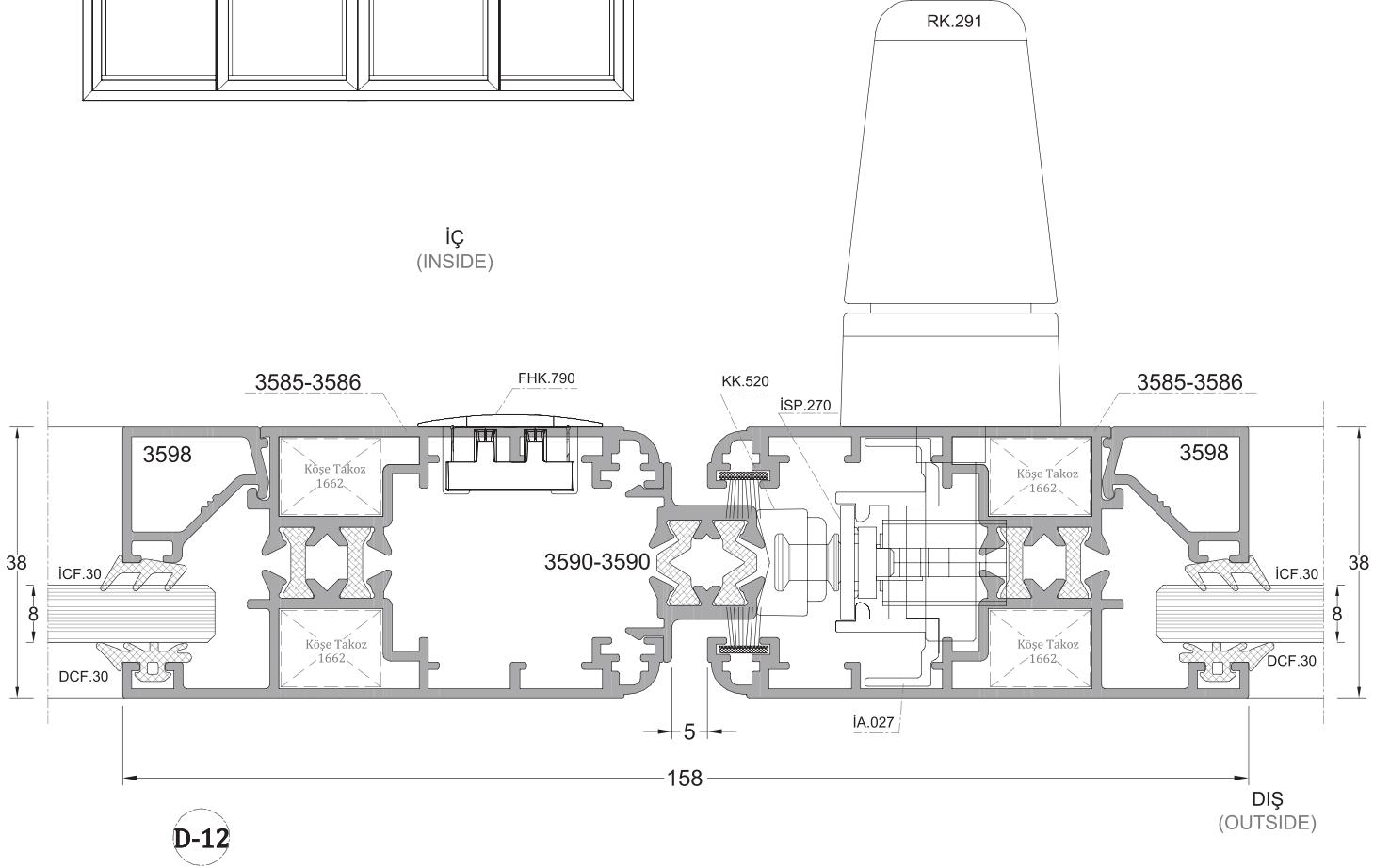
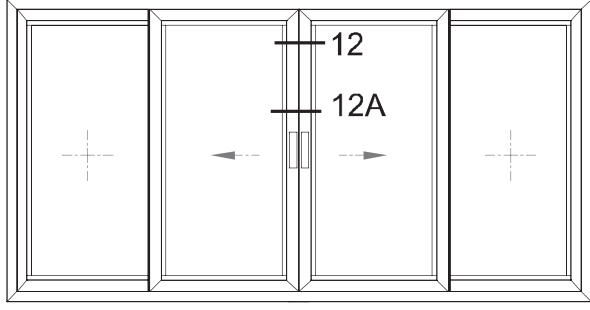

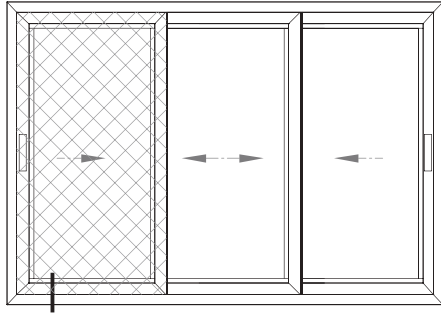

13

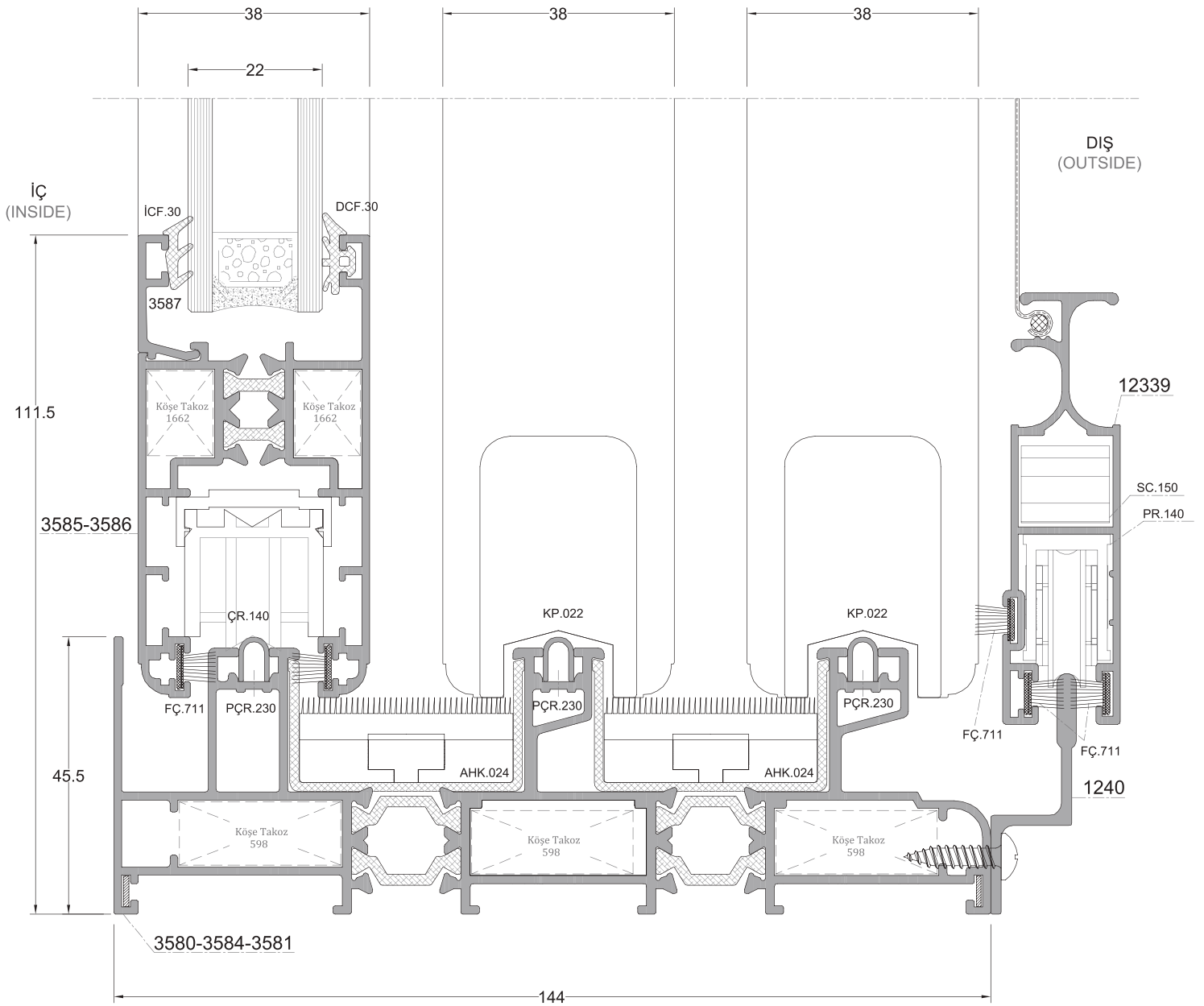

D-13

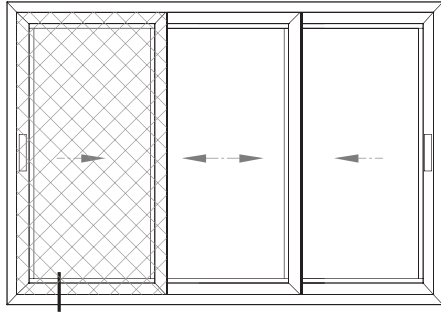

13A

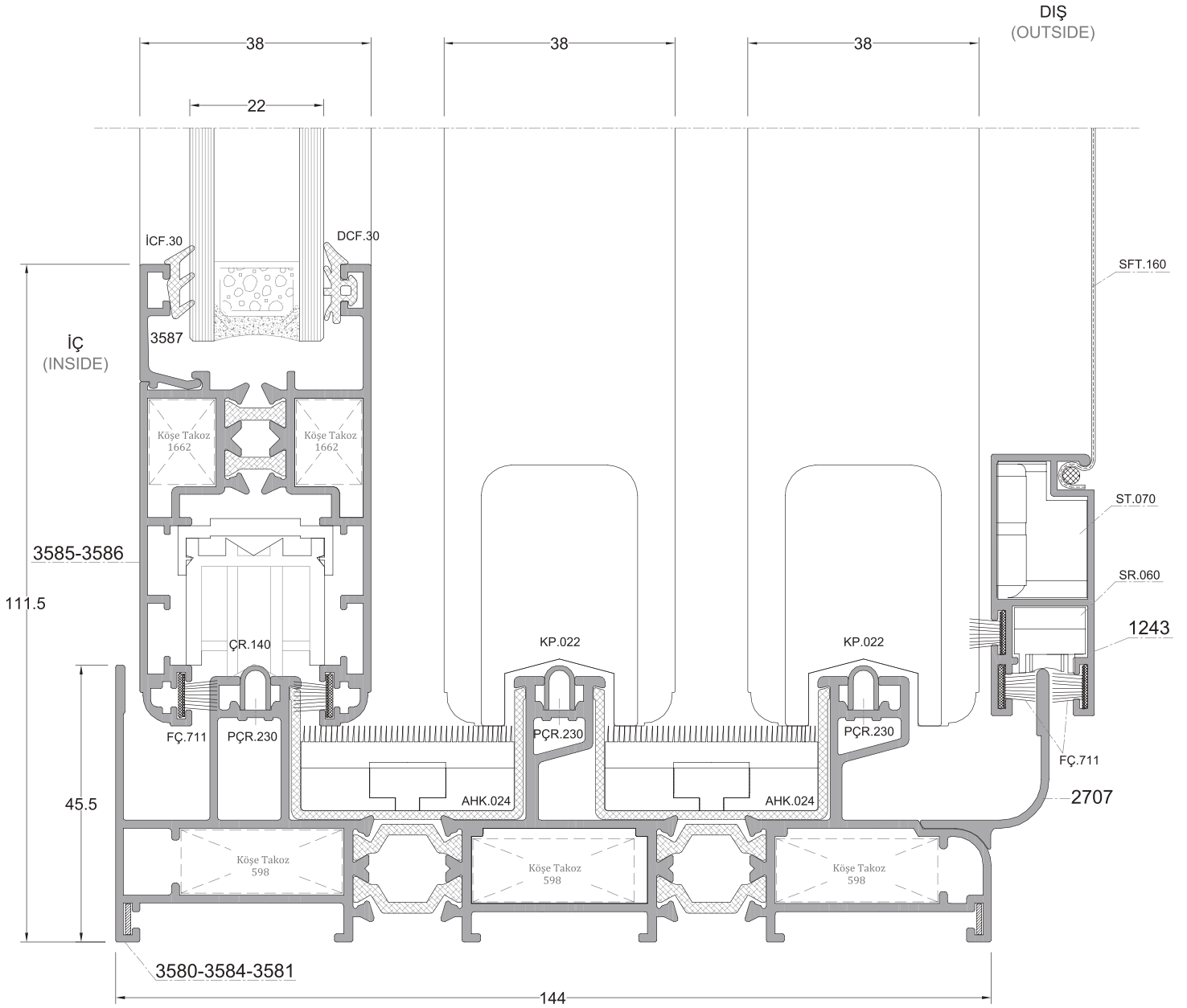

D-13A

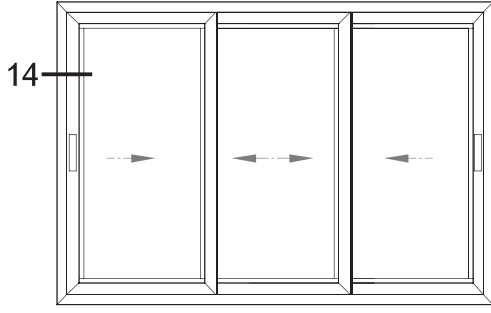

İÇ  
(INSIDE)

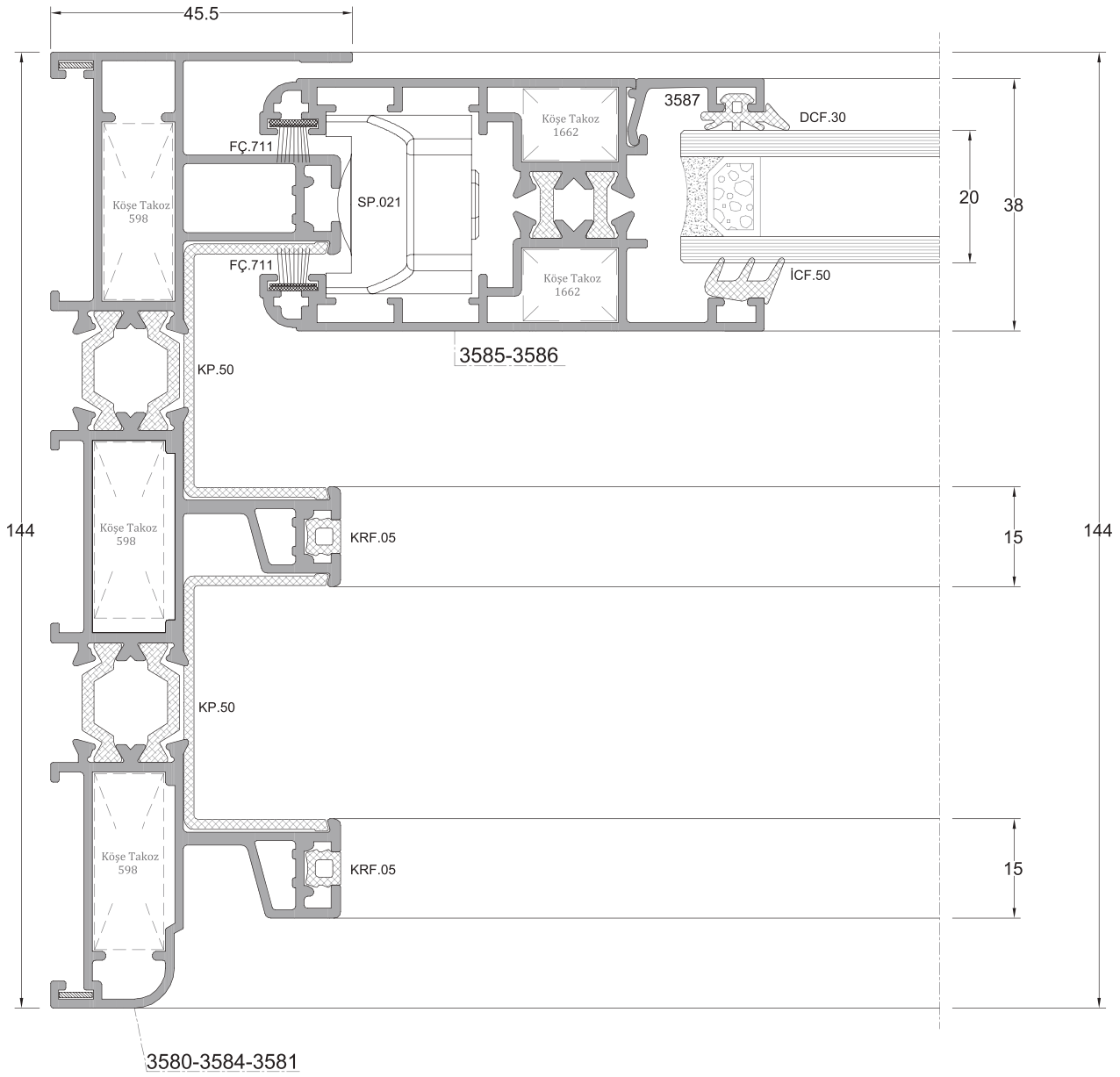

DIŞ  
(OUTSIDE)

D-14

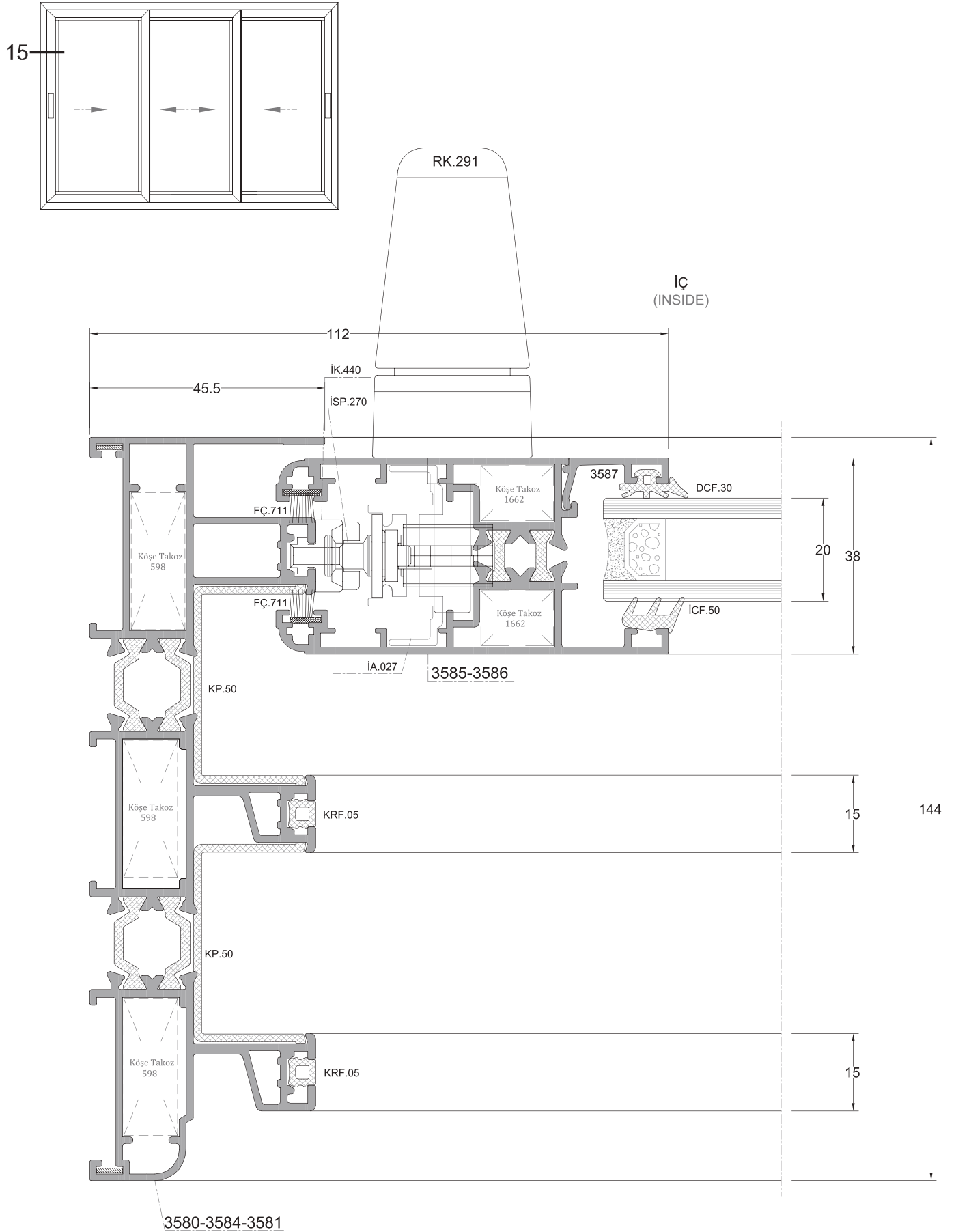

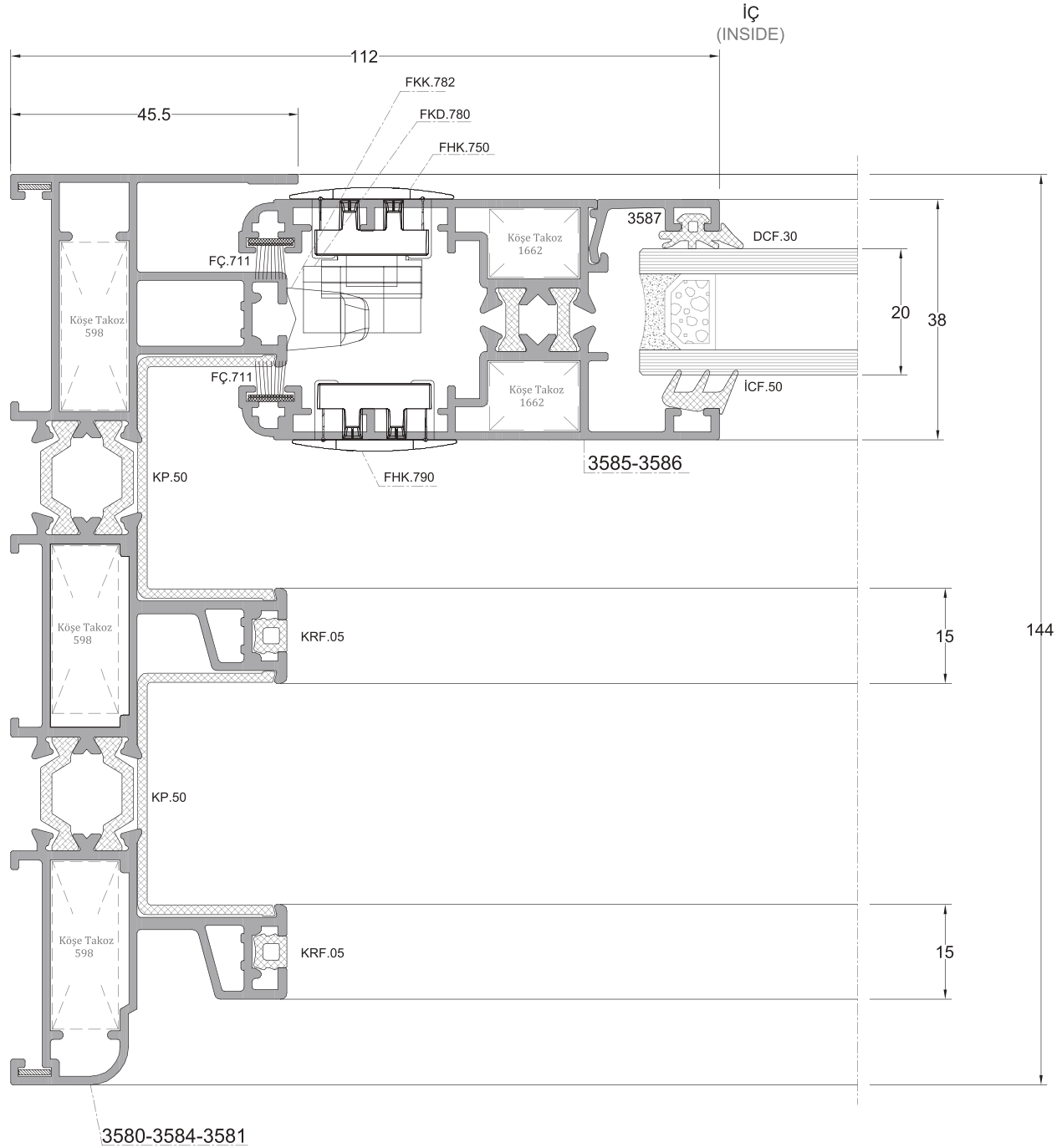
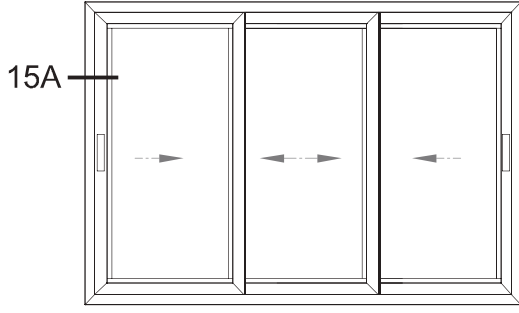

D-15A

DIŞ  
(OUTSIDE)

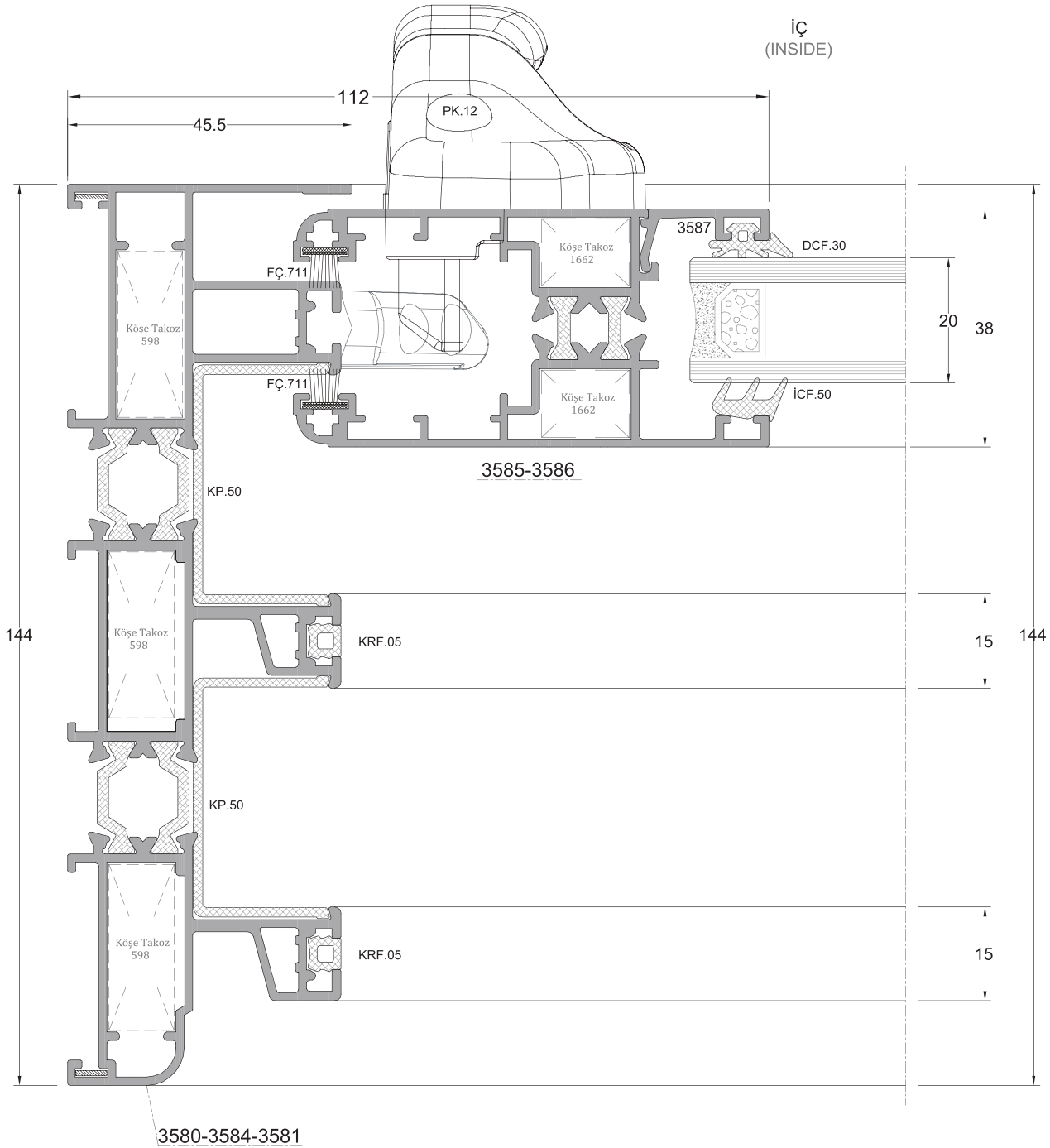
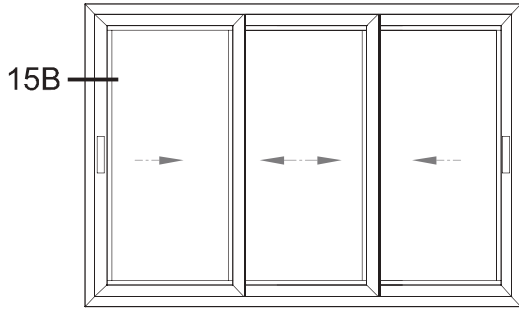

**D-15B**

DIŞ  
(OUTSIDE)

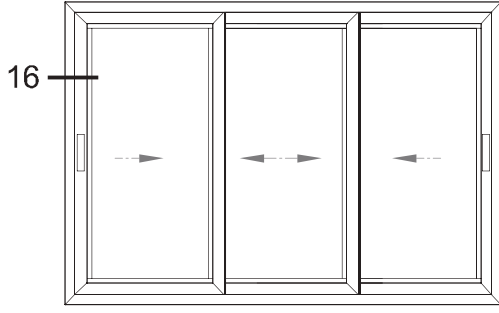

İÇ  
(INSIDE)

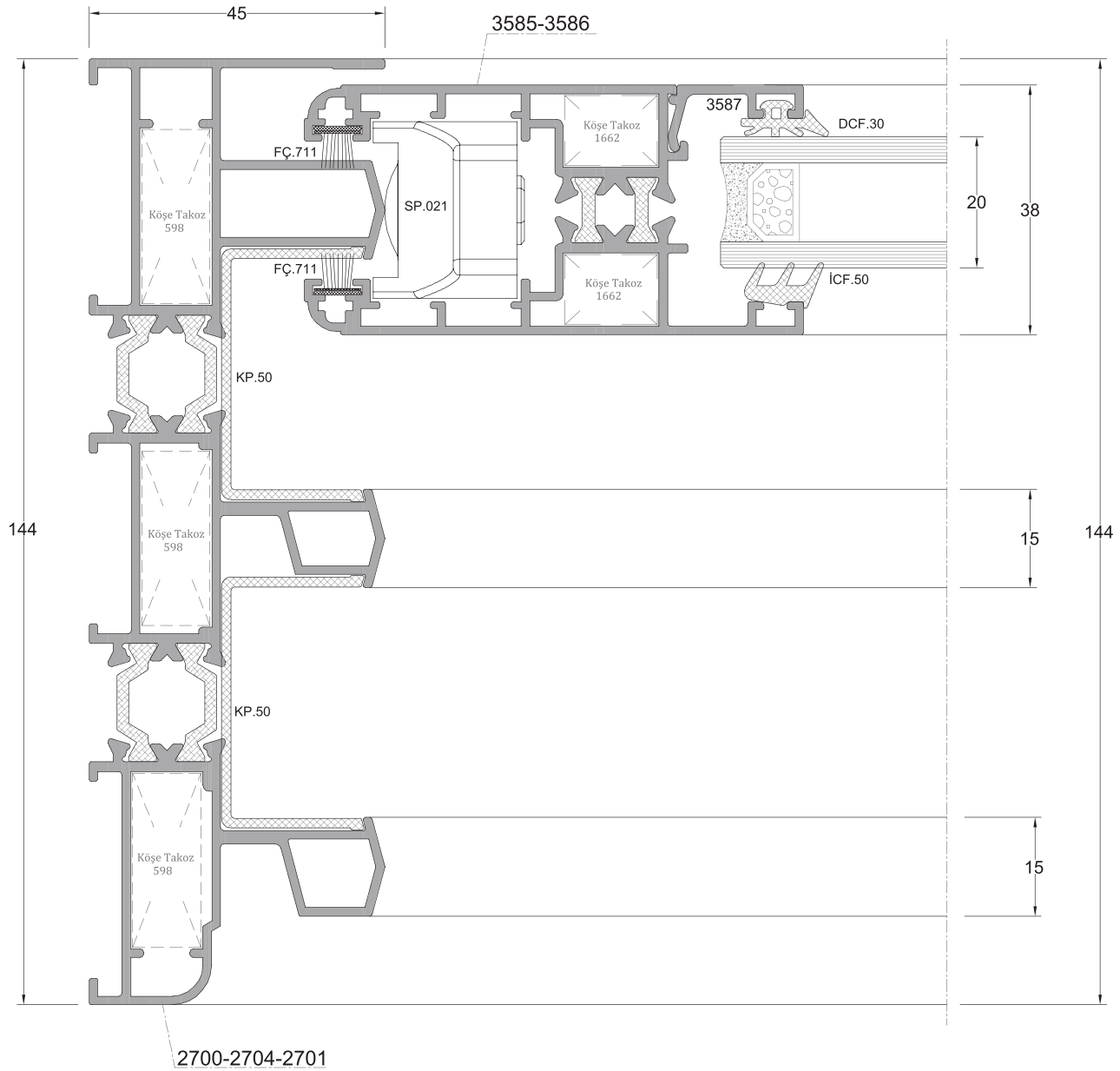

DIŞ  
(OUTSIDE)

D-16



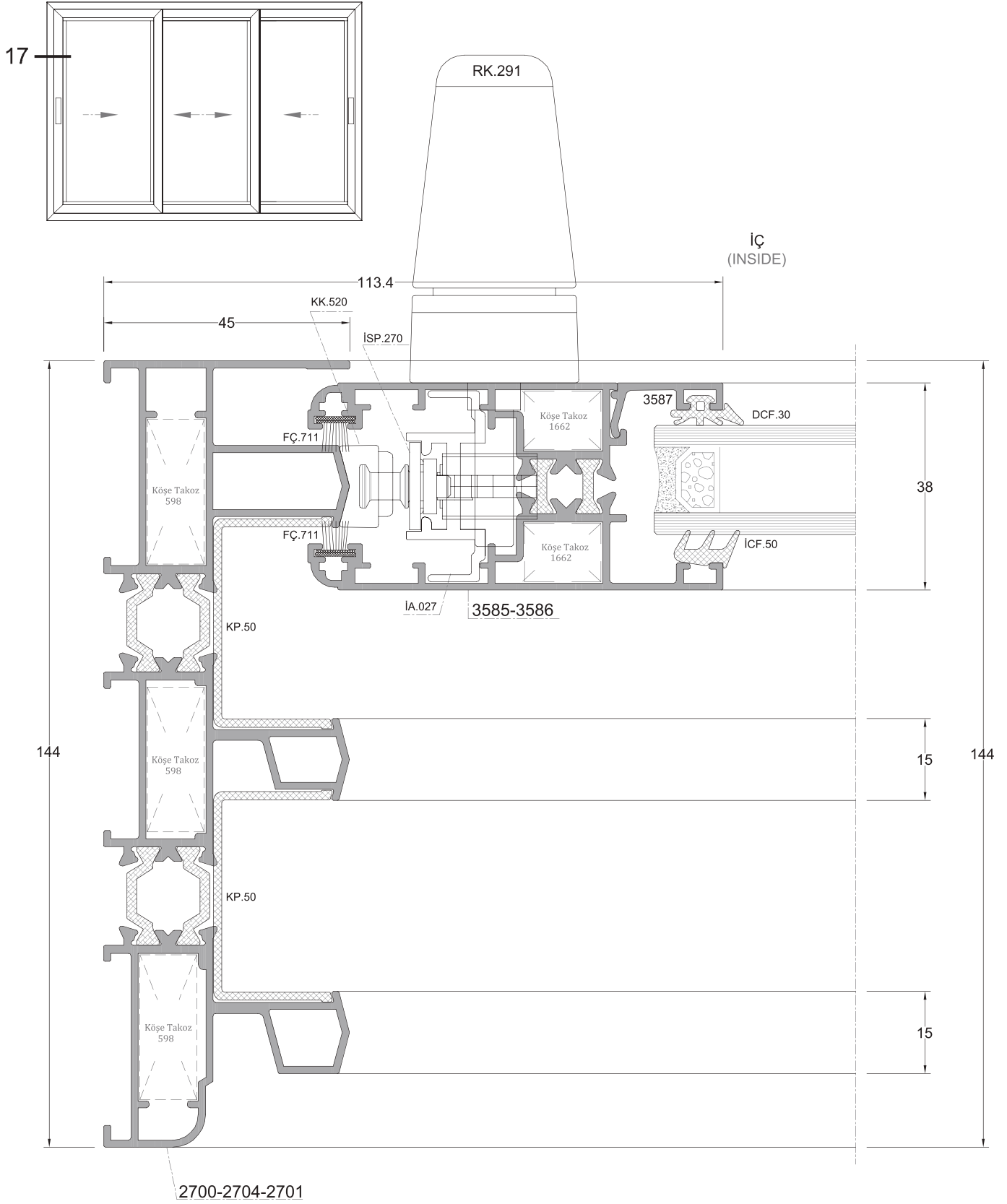

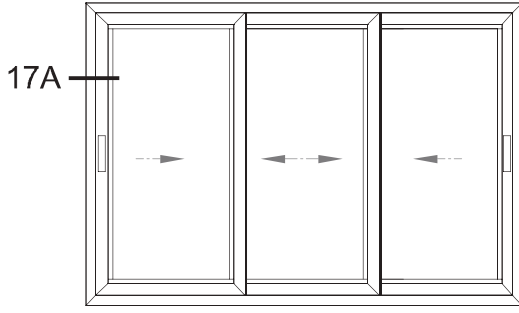

İÇ  
(INSIDE)

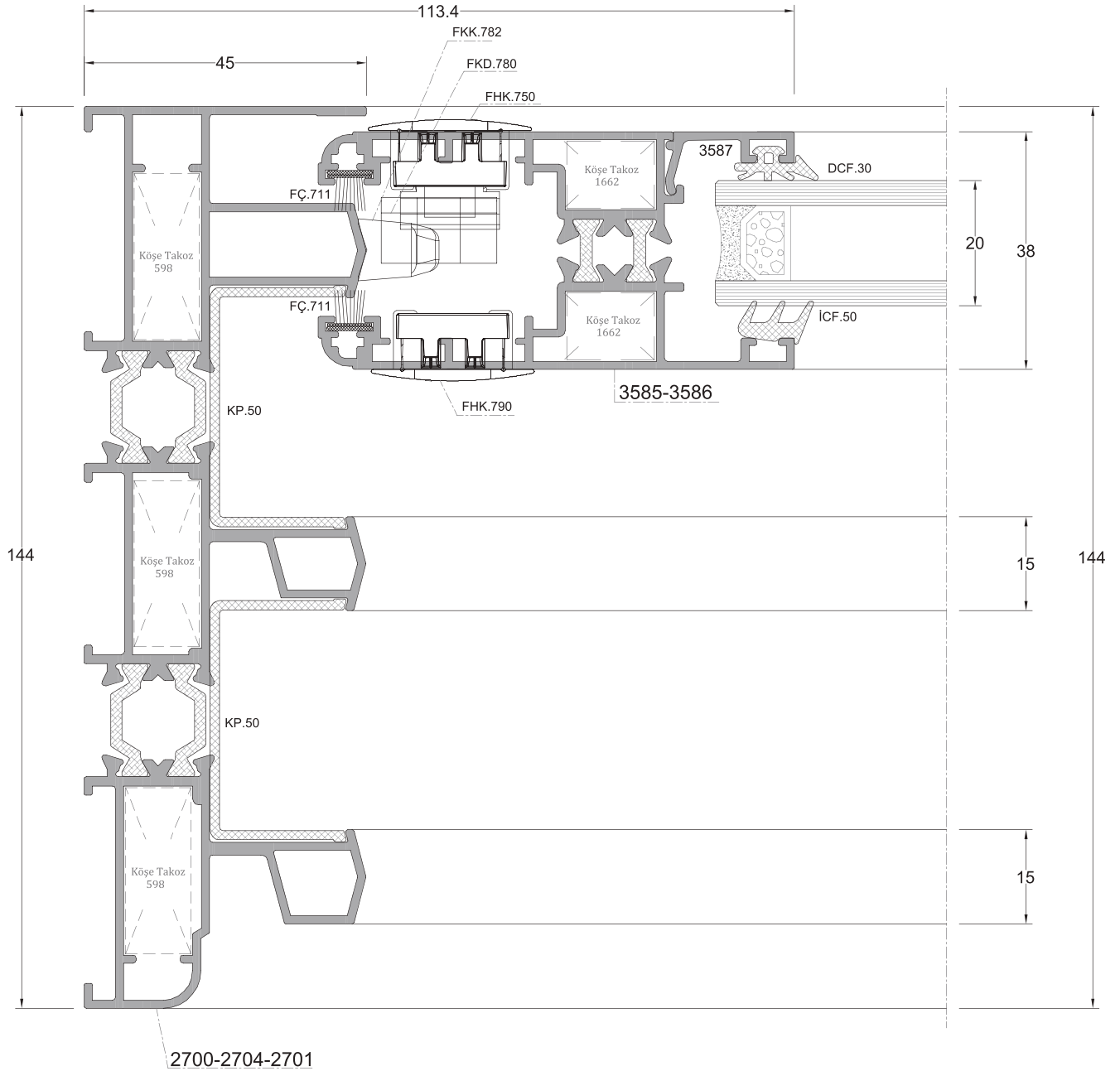

DİŞ  
(OUTSIDE)

D-17A

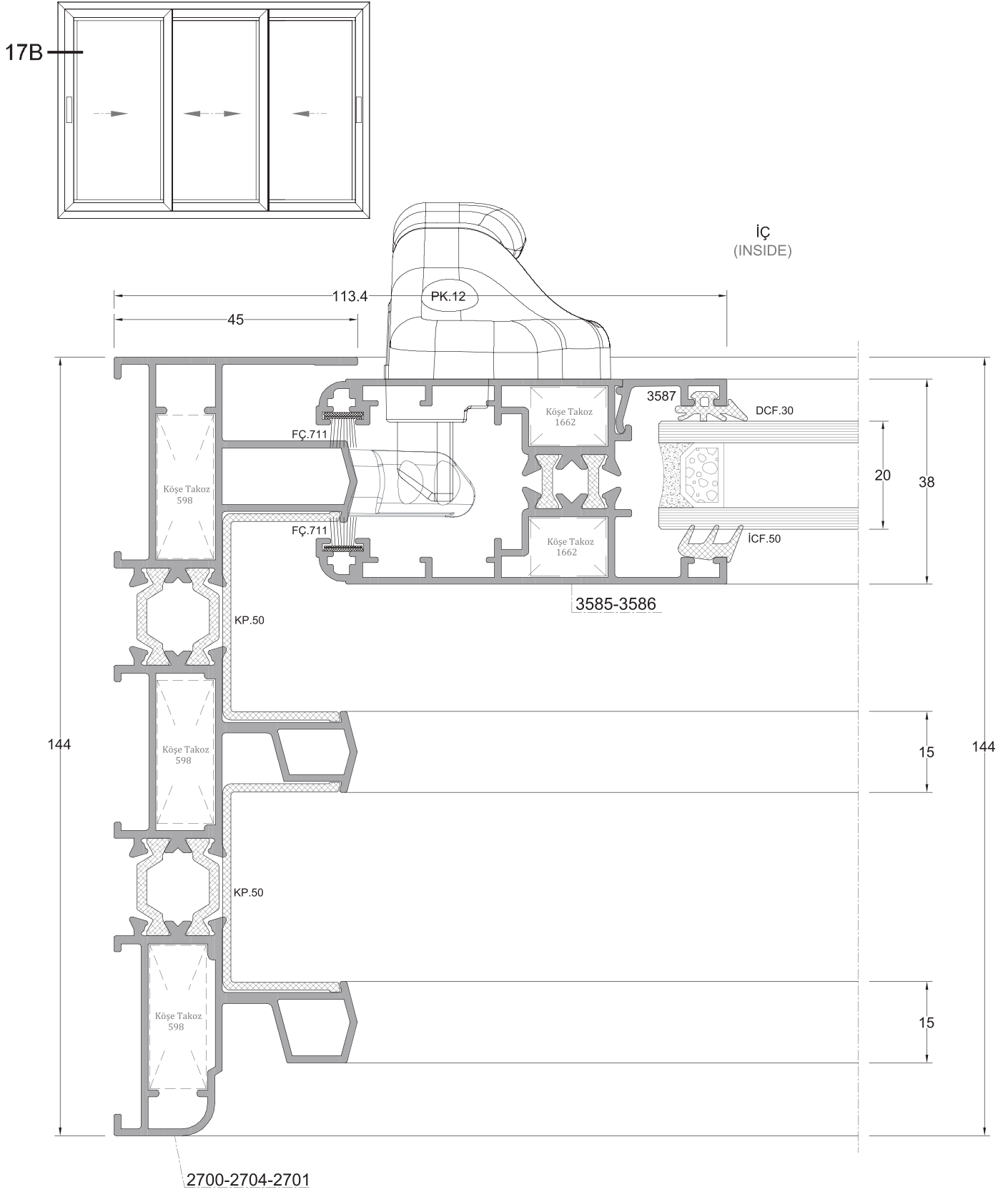

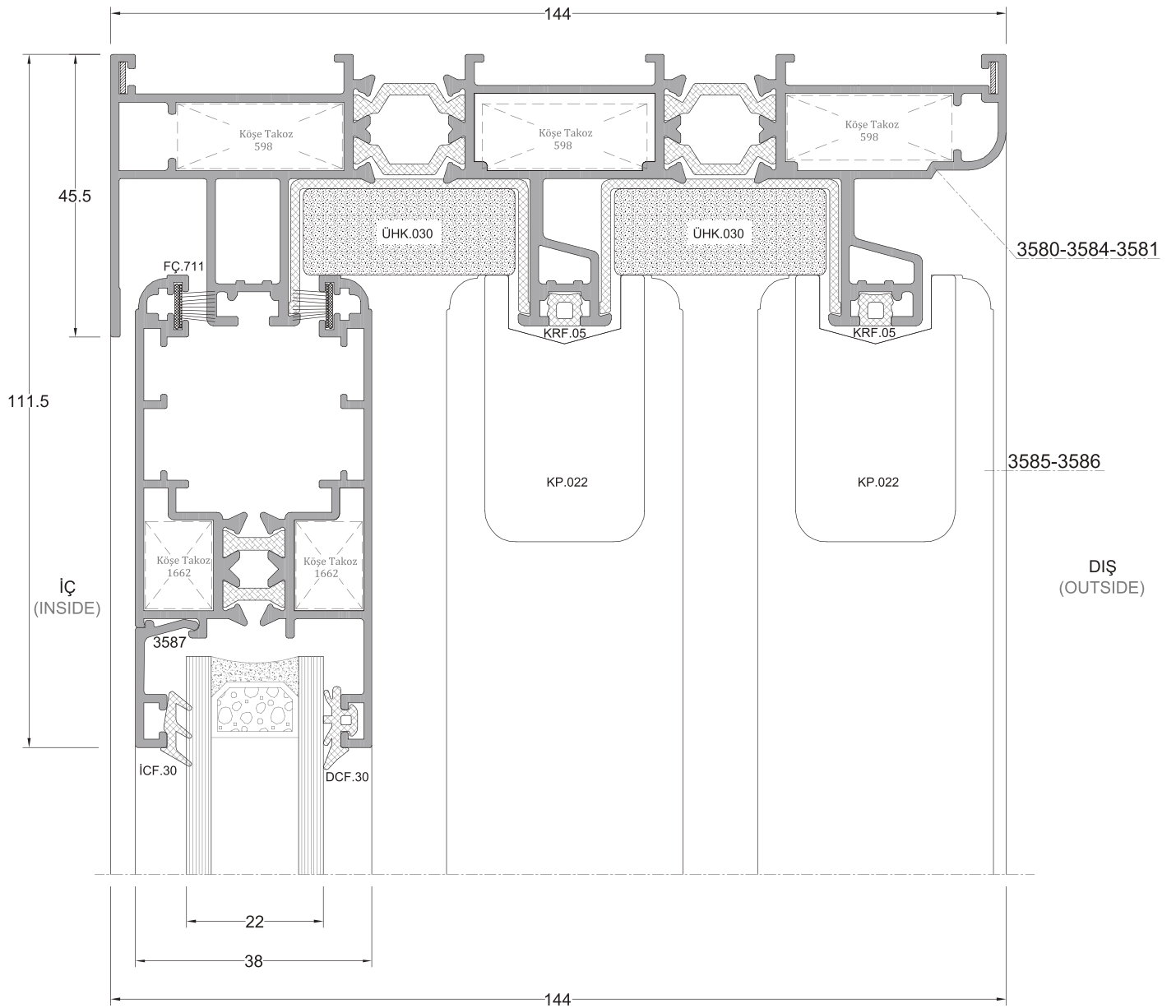
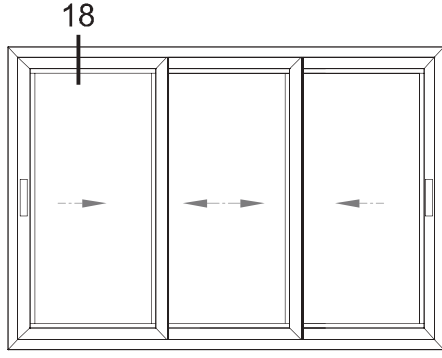

D-18

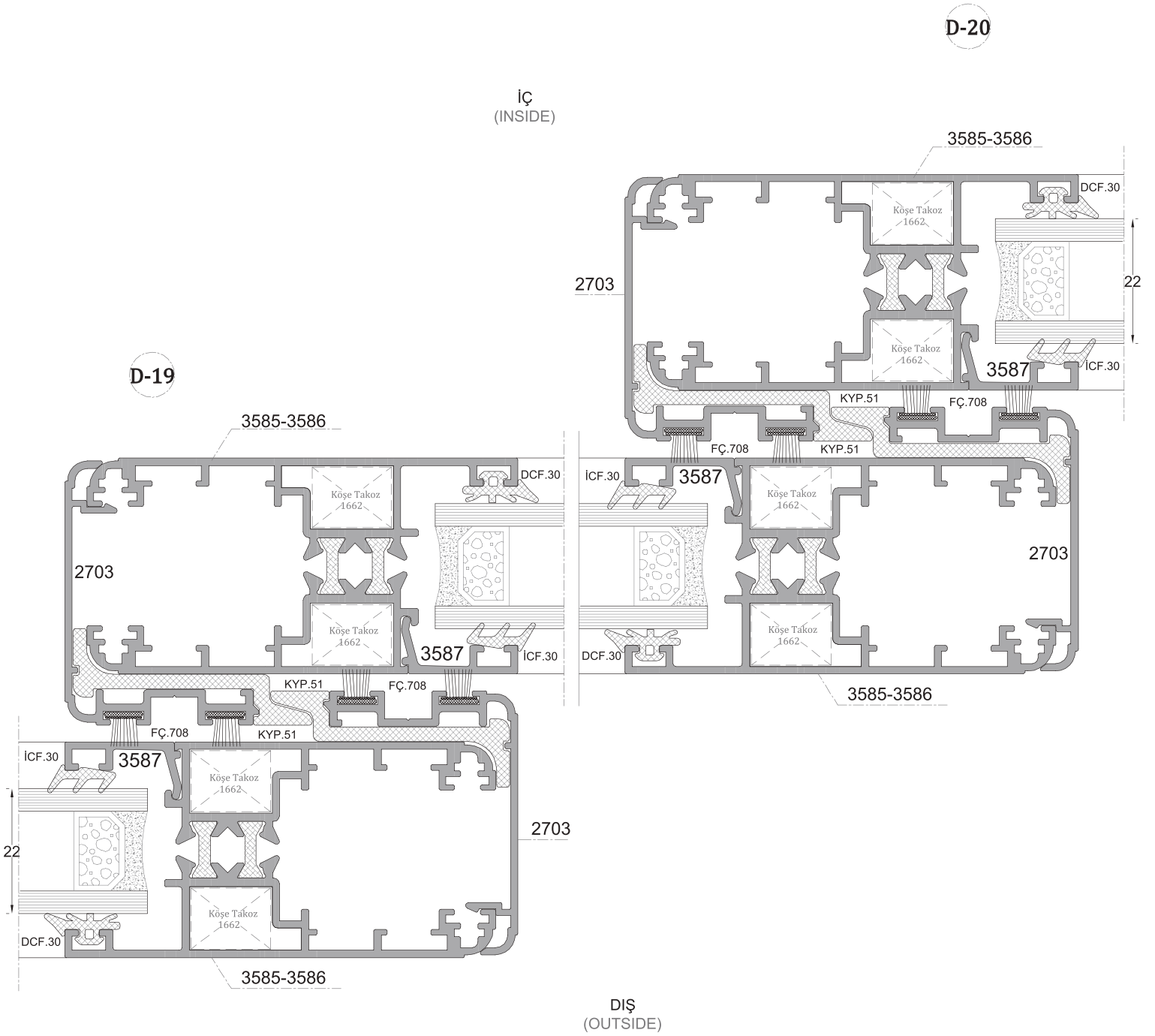
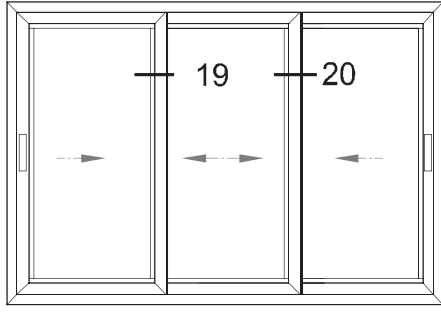

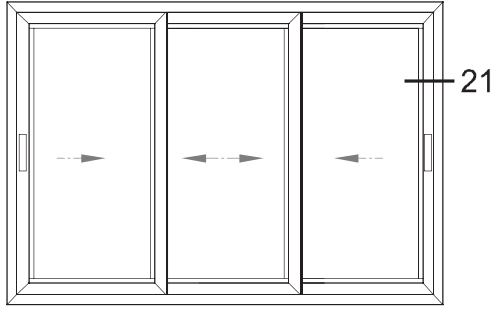

D-21

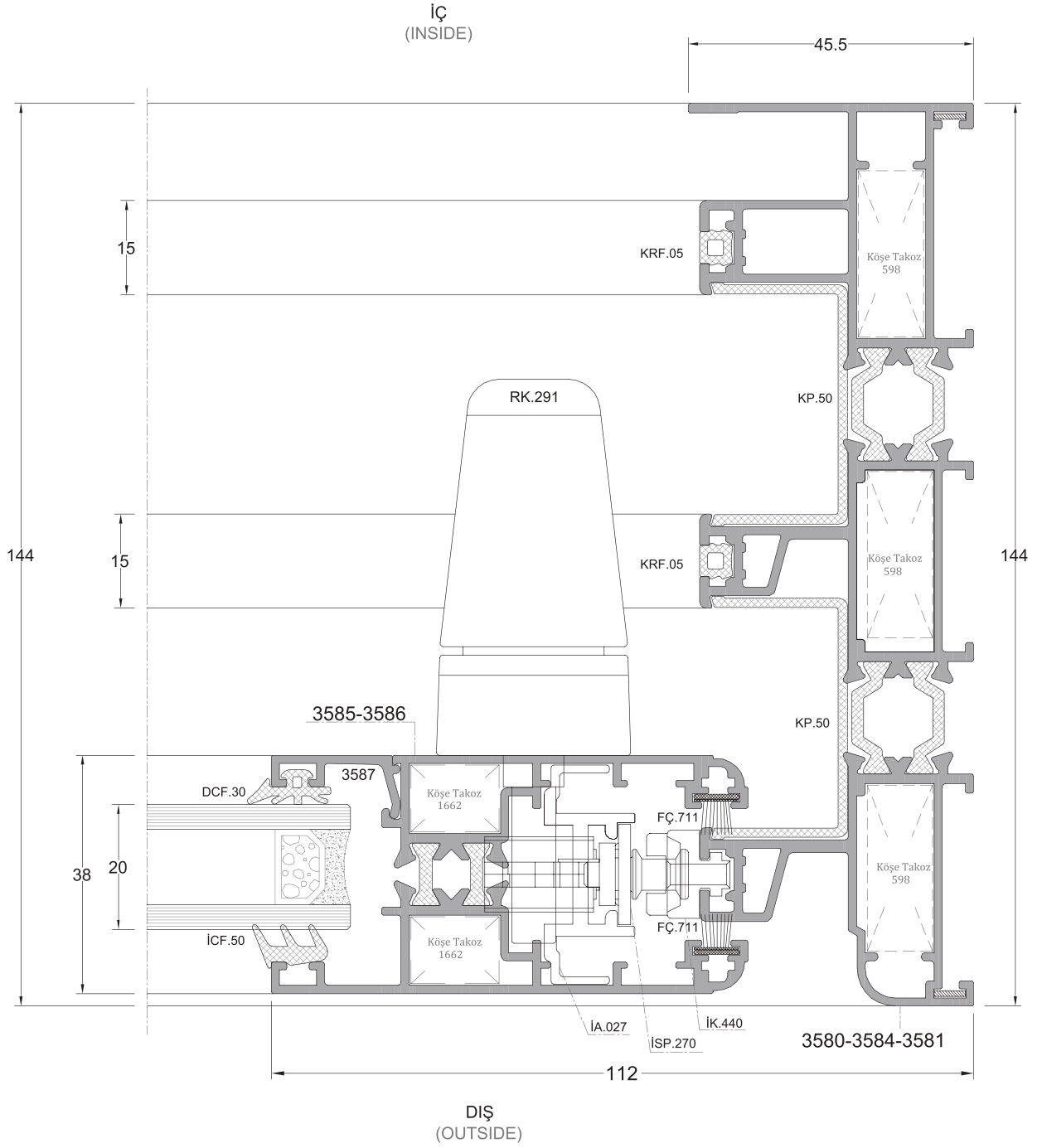



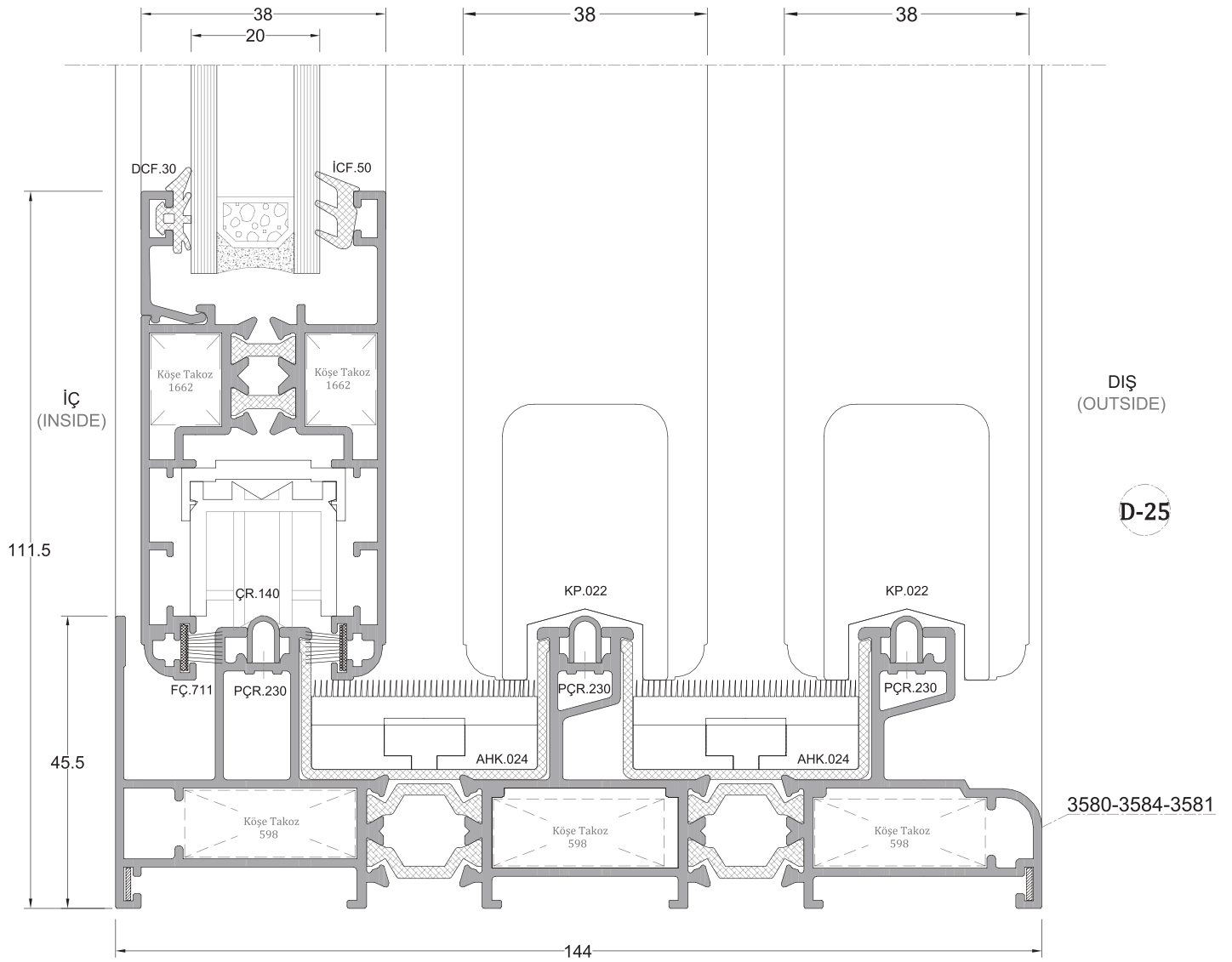
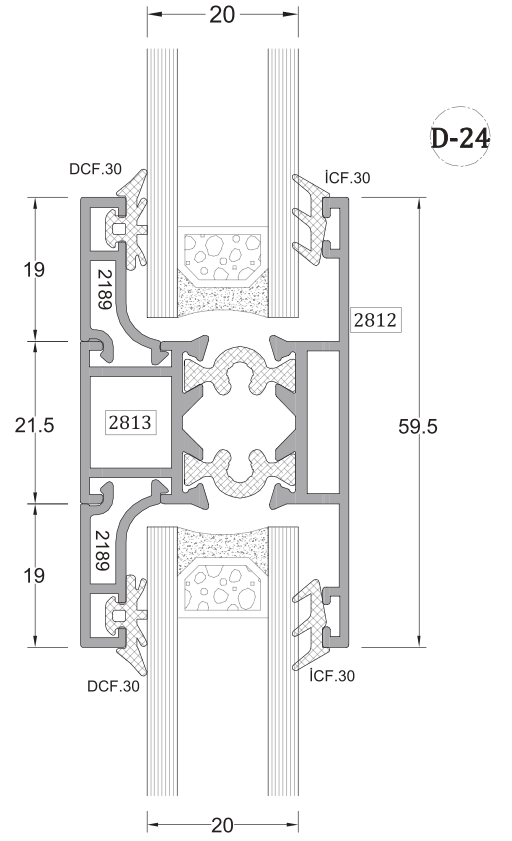
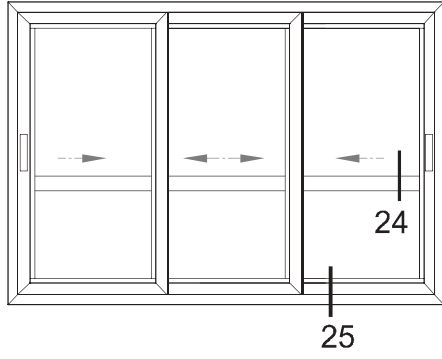



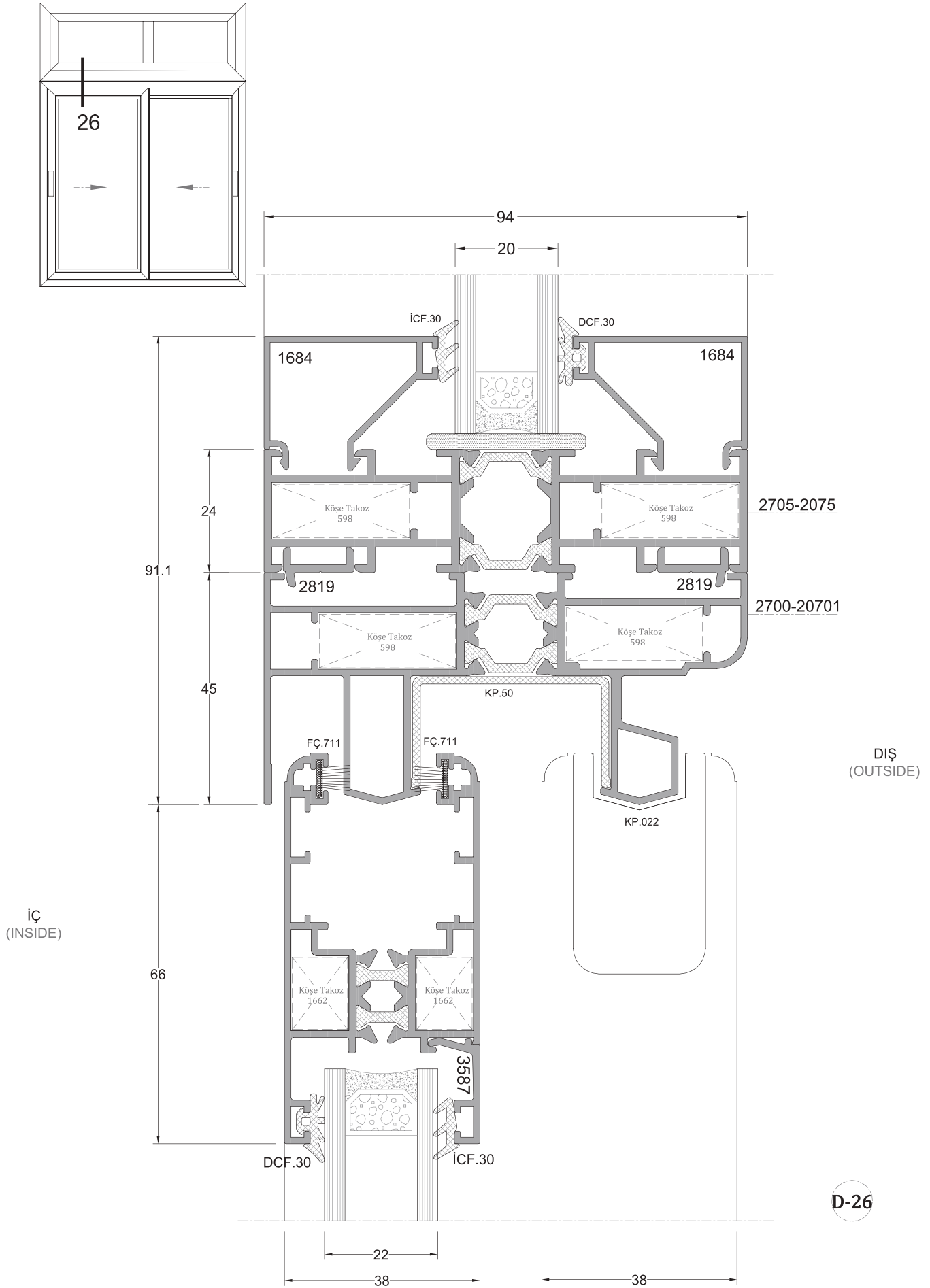

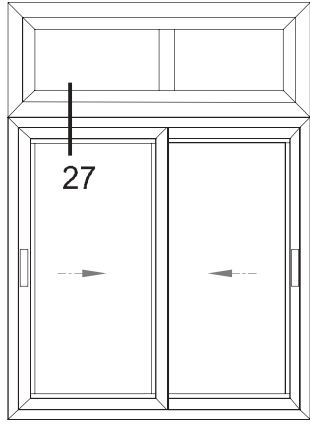

İÇ  
(INSIDE)

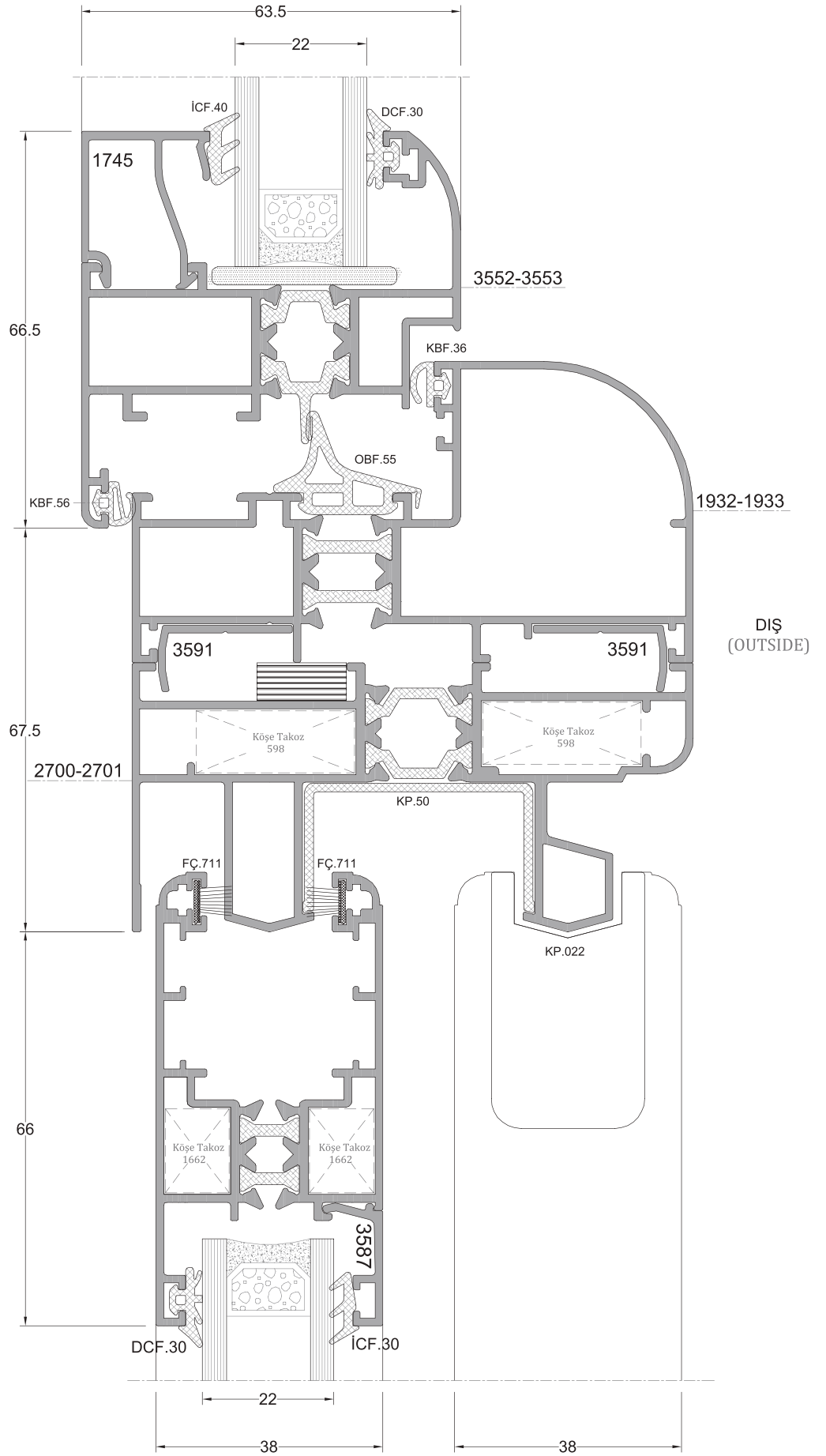

D-27

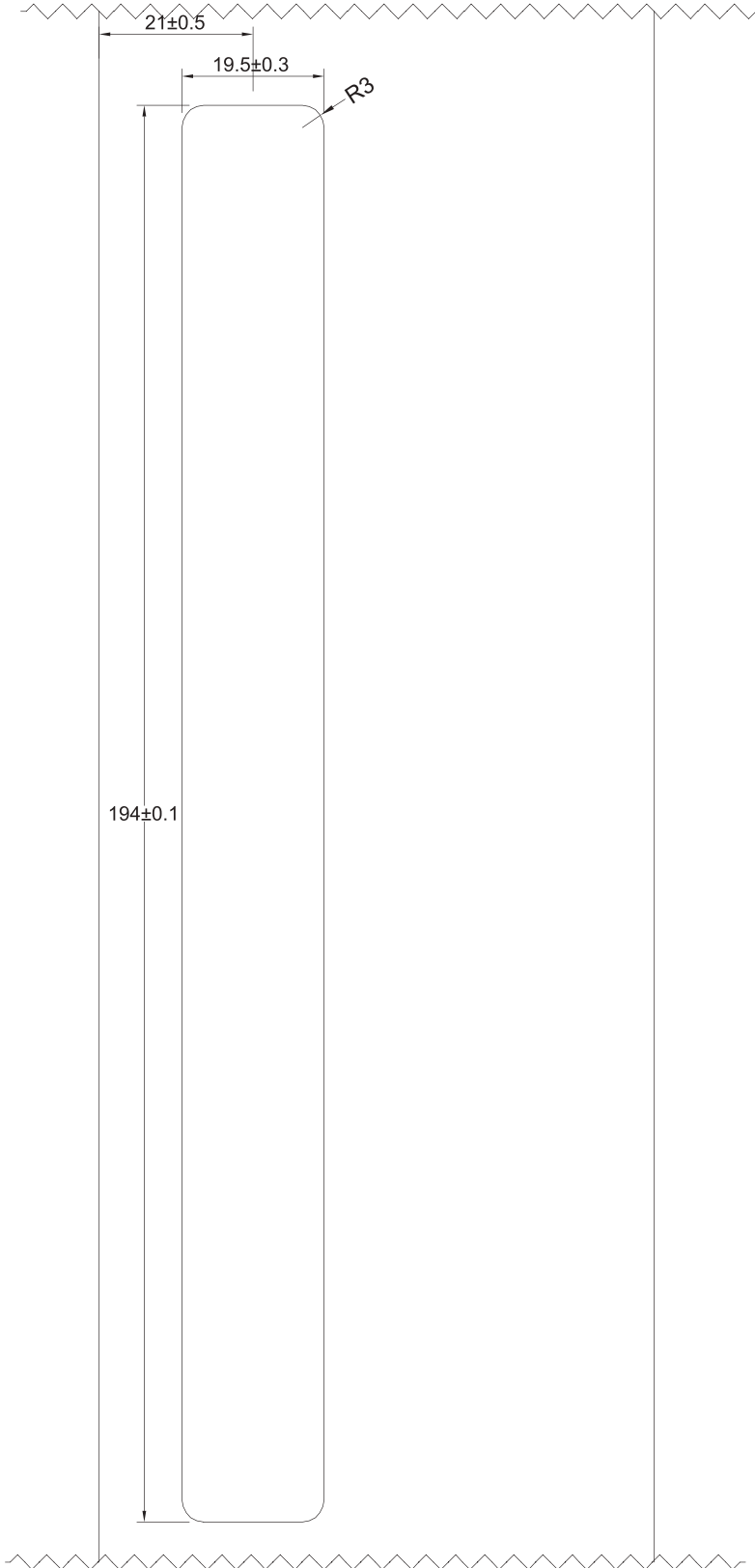
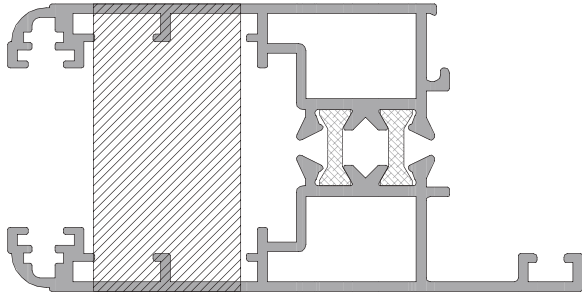

FHK.750

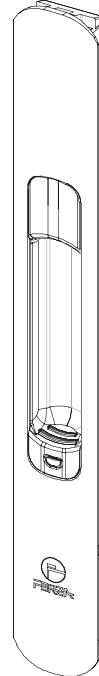

FKD.780



FKK.782

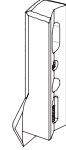

FPK.790

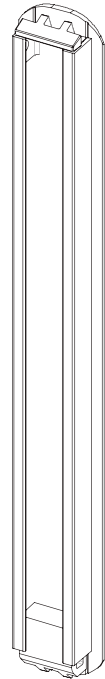

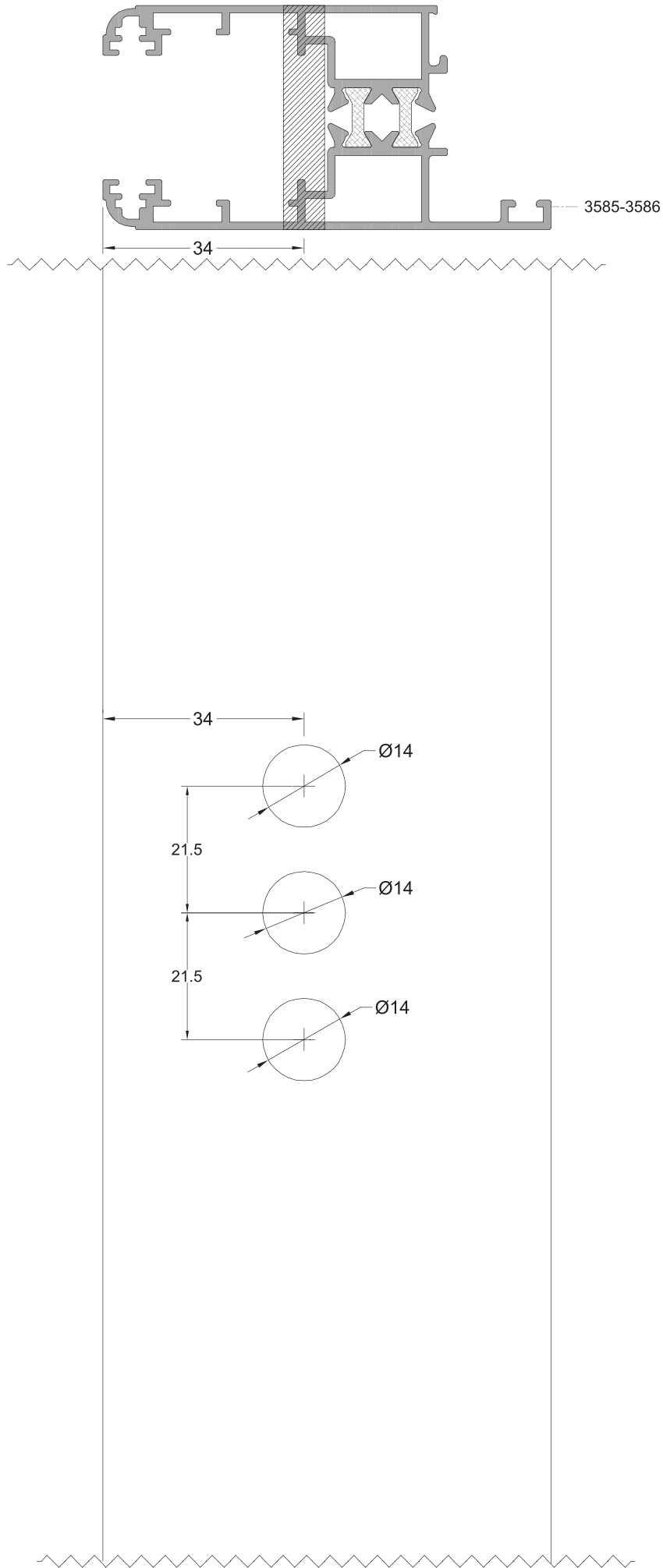

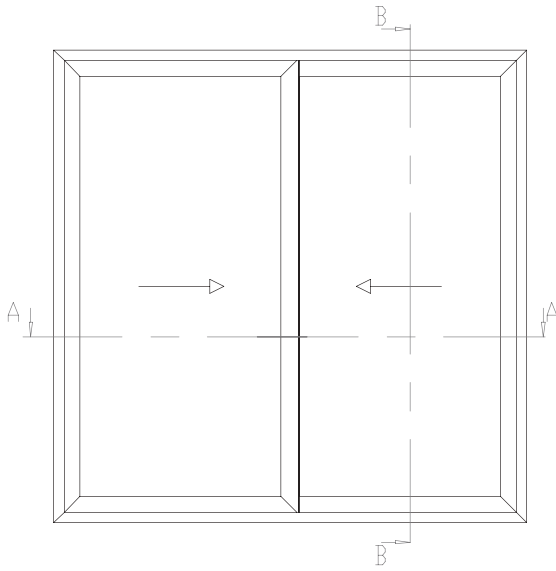

**B-B KESİTİ**

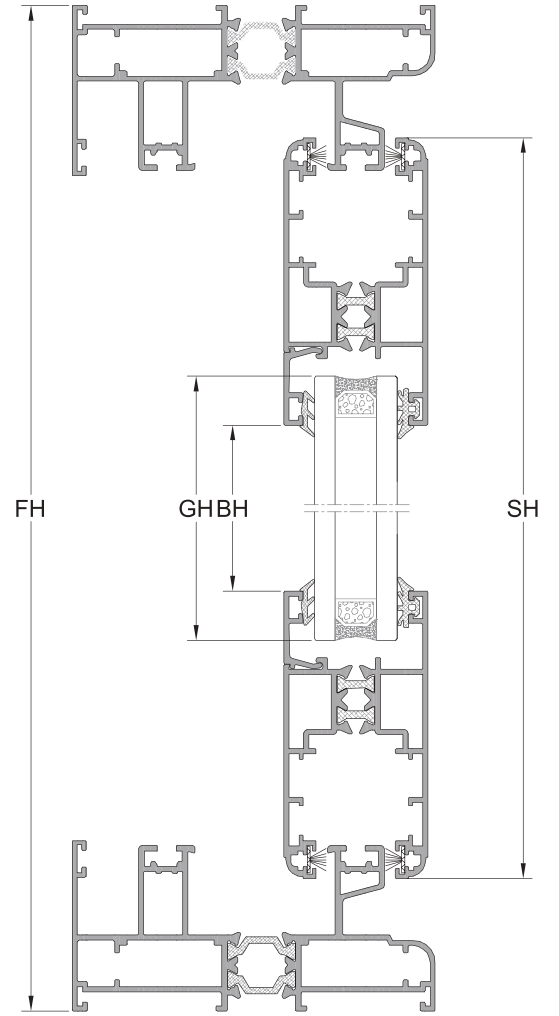

**PROFİLLER / PROFILES**

Kod Code	Çizim Drawing	Kesim Cut	Miktar Quantity	Ölçüler Dimensions
5846-3581 Kasa Frame			2 Pcs / Adet	FL
			2 Pcs / Adet	FH
3585-3586 Kanat Sash			4Pcs / Adet	SL = (FL/2)+3
			4Pcs / Adet	SH = FH-71
3587 Çita Bead			4Pcs / Adet	BL = SL - 113,5
			4Pcs / Adet	BH = SH - 152

**CAM / GLASS**

Kod Code	Çizim Drawing	Miktar Quantity	Ölçüler Dimensions
CAM GLASS		2 Pcs / Adet	GL = SL-127
			GH = SH-127

CAM ÖLÇÜLERİ EŞİT KABUL EDİLEREK  
FORMULİZE EDİLMİŞTİR.

GLASS DIMENSIONS ARE  
FORMULATED, ACCEPT EQUAL.

**A-A KESİTİ**

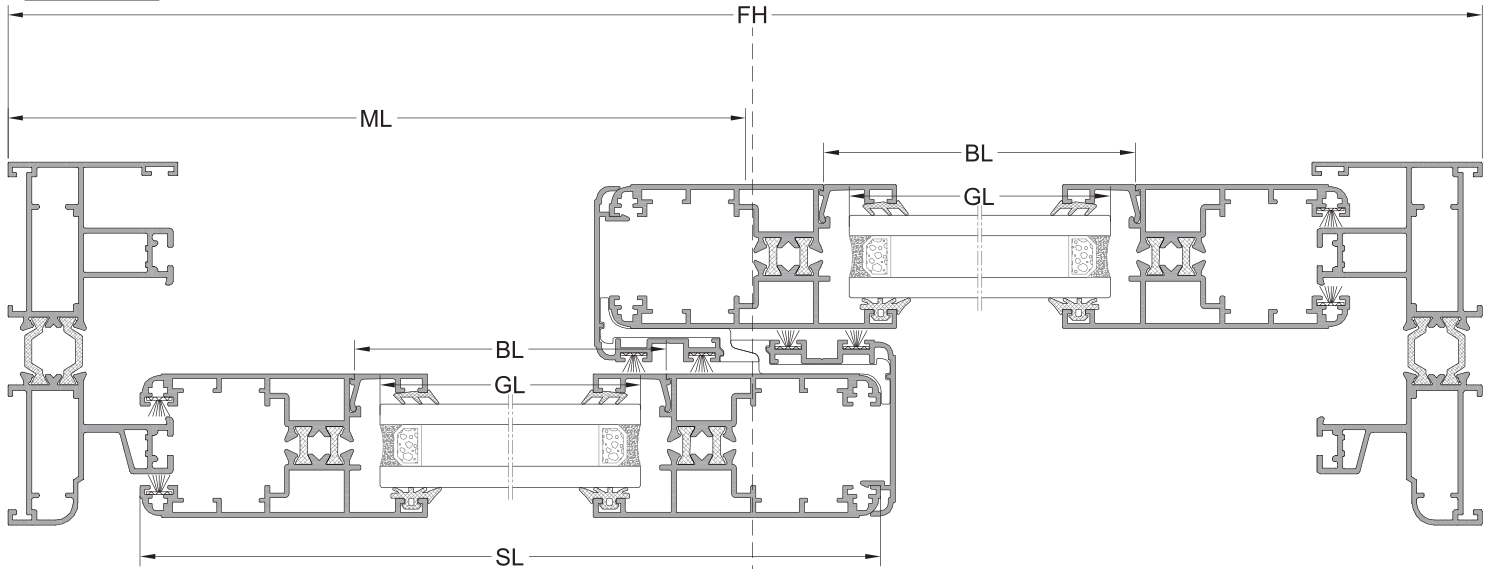

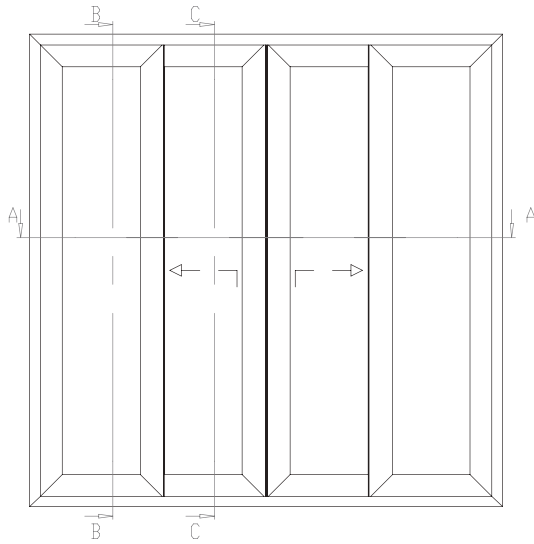

**B-B KESİTİ**

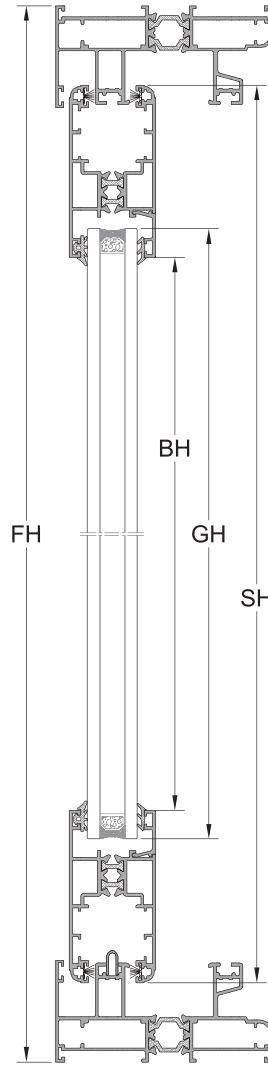

**C-C KESİTİ**

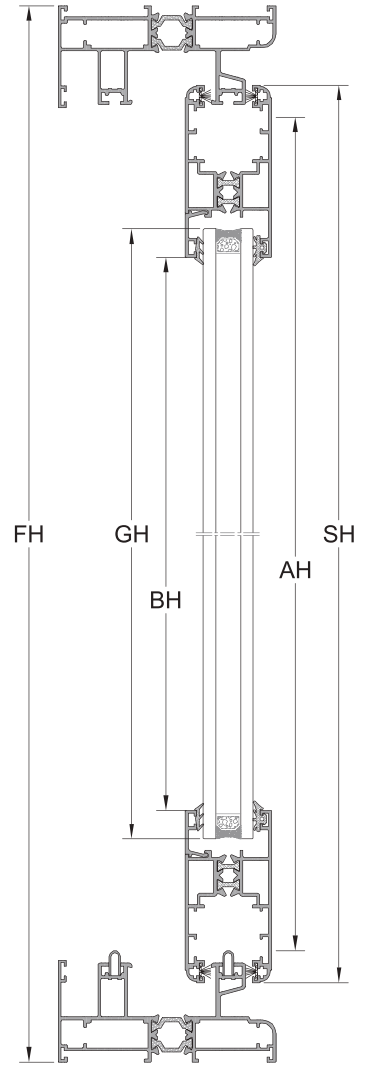

**PROFİLLER / PROFILES**

Kod Code	Çizim Drawing	Kesim Cut	Miktar Quantity	Ölçüler Dimensions
5846-3581 Kasa Frame			2 Pcs / Adet	FL
			2 Pcs / Adet	FH
3585-3586 Kanat Sash			8Pcs / Adet	SL = (FL/4)+18
			8Pcs / Adet	SH = FH-71
3585-3586 Adaptör Adapter			1Pcs / Adet	AH = FH-91
3587 Çita Bead			8Pcs / Adet	BL = SL - 113,5
			8Pcs / Adet	BH = SH - 152

**CAM / GLASS**

Kod Code	Çizim Drawing	Miktar Quantity	Ölçüler Dimensions
CAM GLASS		4 Pcs / Adet	GL = SL-127 GH = SH-127

CAM ÖLÇÜLERİ EŞİT KABUL EDİLEREK FORMULİZE EDİLMİŞTİR.

GLASS DIMENSIONS ARE FORMULATED, ACCEPT EQUAL.

**A-A KESİTİ**

