



Sürme Sistem
Sliding System



S35

NOVO LINE

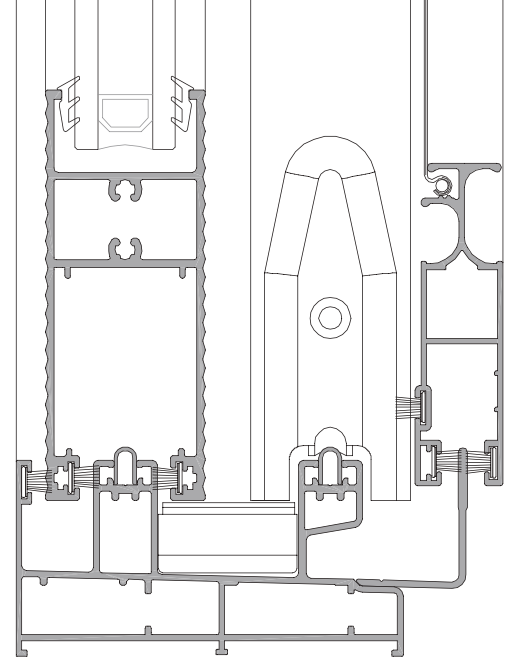

TEKNİK ÖZELLİKLER / TECHNICAL PROPERTIES

KASA DERİNLİĞİ / FRAME DEPTH	85 - 130 mm
KANAT DERİNLİĞİ / SASH DEPTH	35 mm
KENET DERİNLİĞİ / INTERLOCKING DEPTH	80 - 152 mm
PROFİL ET KALINLIĞI / PROFİLE WALL THICKNESS	1,3 - 1,5 mm
MİN. CAM KALINLIĞI / MIN. GLAZING THICKNESS	20 mm
MAKS. CAM KALINLIĞI / MAX. GLAZING THICKNESS	22 mm
MİN. KANAT ÖLÇÜLERİ / MIN. SASH DIMENSIONS	800 x 1900 mm
MAKS. KANAT ÖLÇÜLERİ / MAX. SASH DIMENSIONS	1600 x 2800 mm
MAKS. KANAT AĞIRLIĞI / MAX. SASH WEIGHT	160 kg

UYGULAMA SEÇENEKLERİ / APPLICATION OPTIONS

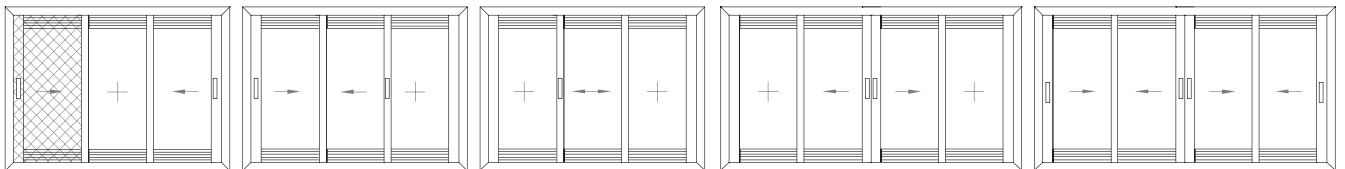
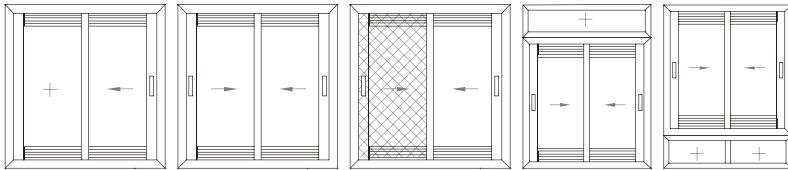

RÜZGAR YÜKÜNE GÖRE KULLANIM LİMİTLERİ GRAFIĞI

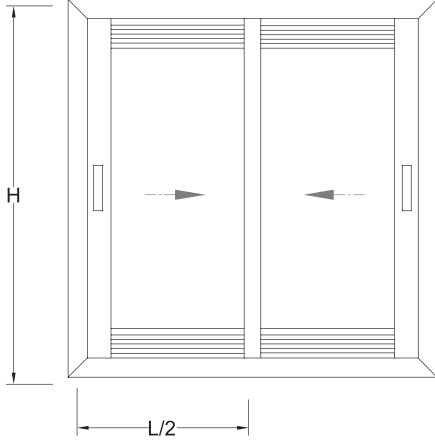

H(cm)

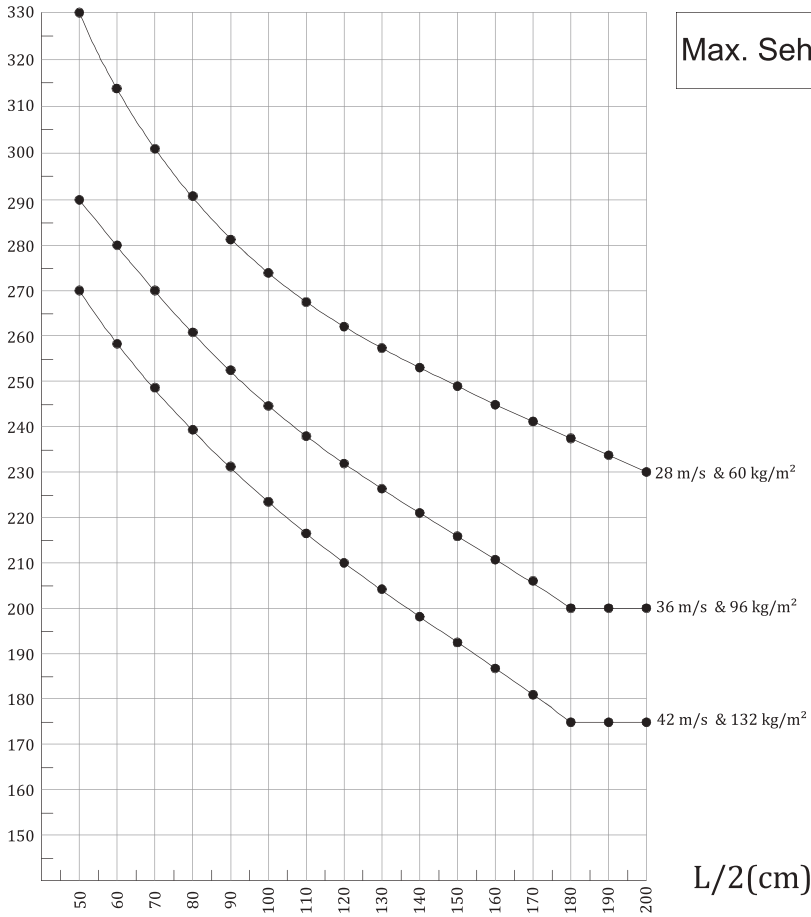

Max. Sehim : L / 300

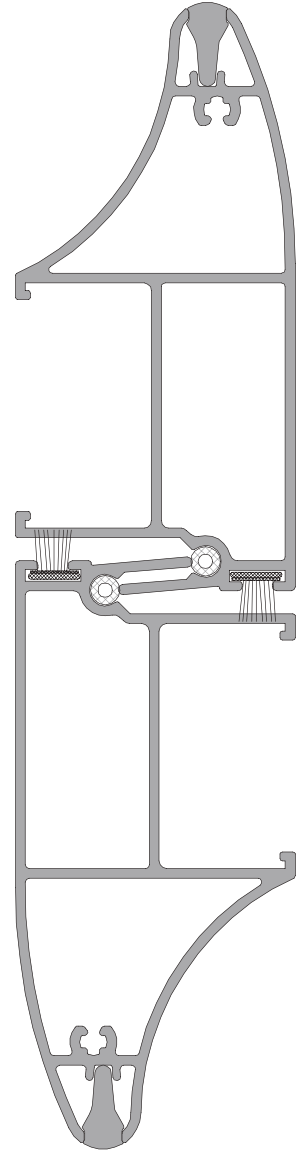
Jx : 40,02 cm⁴

RÜZGAR YÜKÜNE GÖRE KULLANIM LİMİTLERİ GRAFIĞI

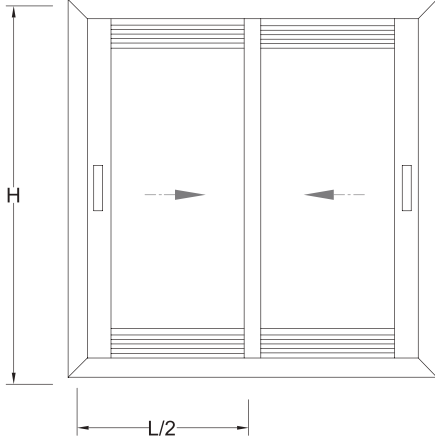

H(cm)

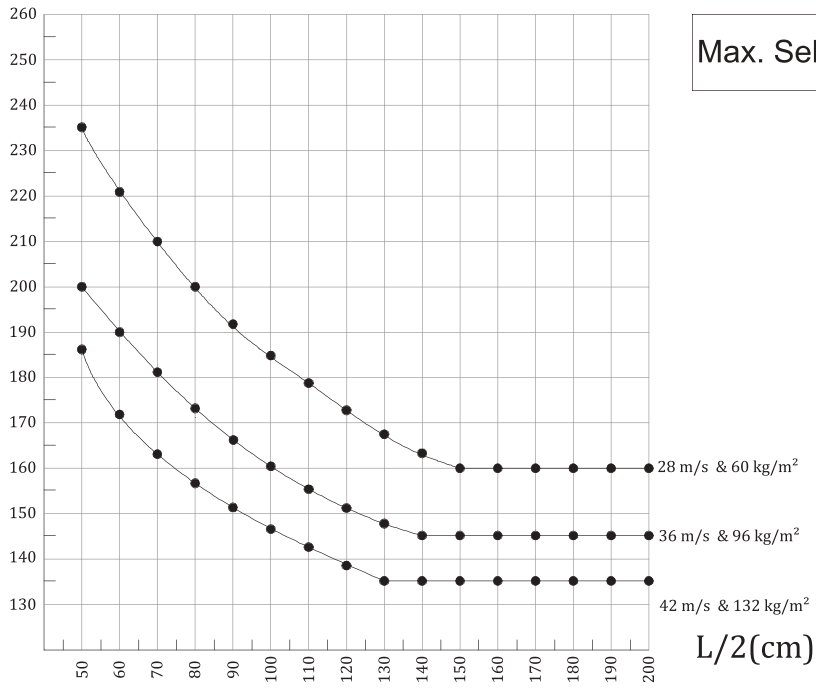

Max. Sehim : L / 300

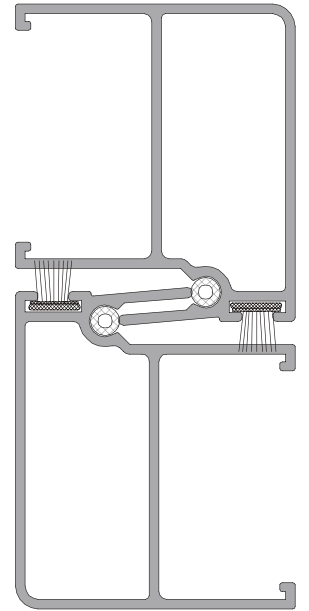
Jx : 10,82 cm⁴

RÜZGAR YÜKÜNE GÖRE KULLANIM LİMİTLERİ GRAFIĞI

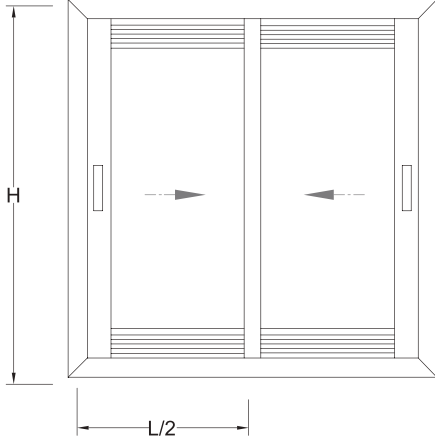



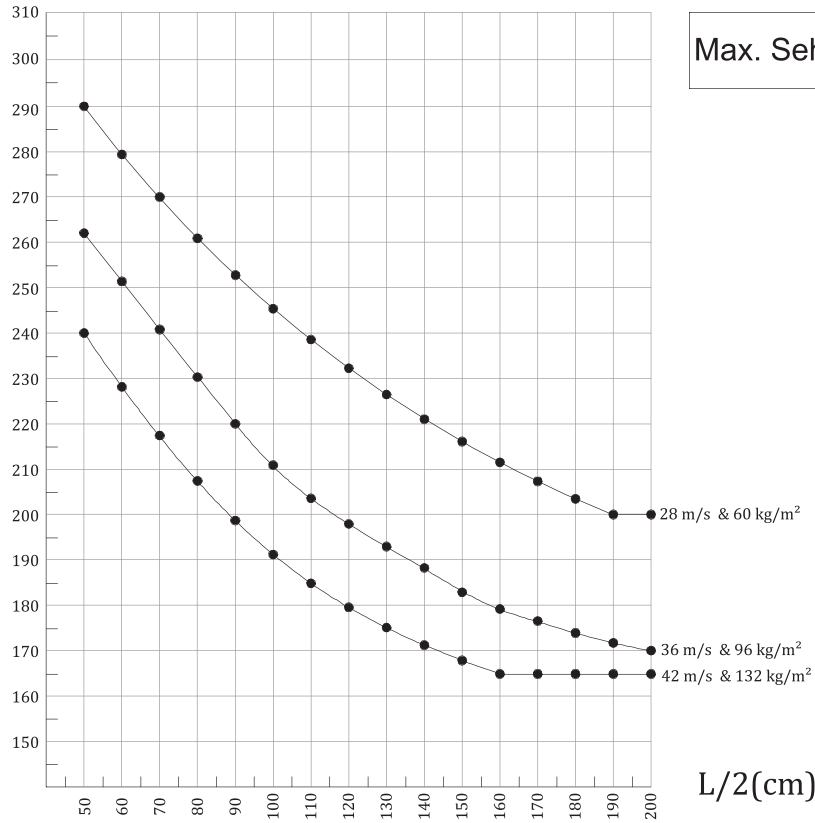
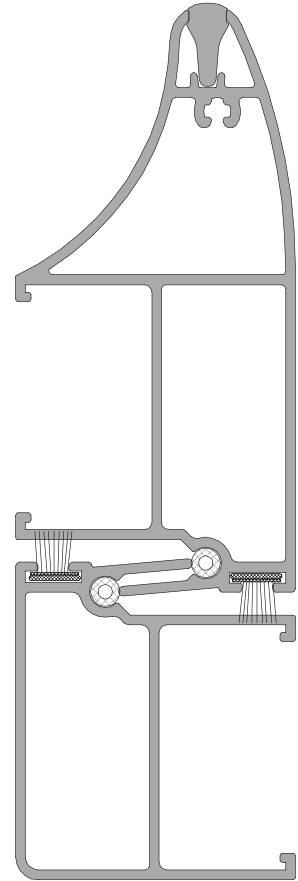







H(cm)

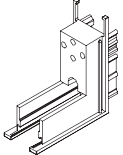
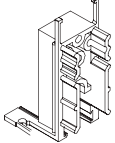
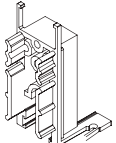
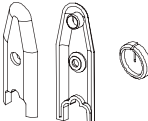
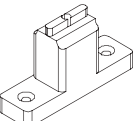
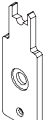
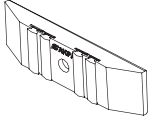
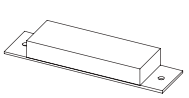

Max. Sehim : $L / 300$  $J_x : 25,42 \text{ cm}^4$

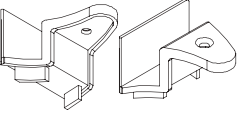
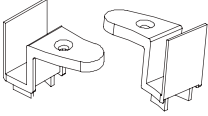
PROFİL KESİTİ PROFILE SECTION	PROFİL KODU PROFILE CODE	PROFİL ADI PROFILE NAME	Jx cm ⁴	Jy cm ⁴	AĞIRLIK (kg/m) WEIGHT
	5822	İKİ RAYLI KASA PROFİLİ DOUBLE RAIL FRAME PROFILE	9,45 cm ⁴	38,88 cm ⁴	1,488 kg/m
	5823	ÜÇ RAYLI KASA PROFİLİ TRIPLE RAIL FRAME PROFILE	13,55 cm ⁴	129,96 cm ⁴	2,145 kg/m
	11597	İKİ RAYLI SİNEKLİ KASA PROFİLİ DOUBLE RAIL SCREENING FRAME PROFILE	11,54 cm ⁴	91,54 cm ⁴	1,885 kg/m
	5833	KANAT PROFİLİ SASH PROFILE	18,67 cm ⁴	7,99 cm ⁴	1,074 kg/m
	5825	KANAT PROFİLİ SASH PROFILE	34,99 cm ⁴	9,77 cm ⁴	1,331 kg/m
	5834	KANAT PROFİLİ SASH PROFILE	36,71 cm ⁴	13,62 cm ⁴	1,378 kg/m
	5848	KANAT PROFİLİ SASH PROFILE	34,63 cm ⁴	9,81 cm ⁴	1,311 kg/m
	5830	KENET PROFİLİ INTERLOCK PROFILE	5,47 cm ⁴	2,64 cm ⁴	0,614 kg/m
	5831	KENET PROFİLİ INTERLOCK PROFILE	20,03 cm ⁴	3,92 cm ⁴	0,982 kg/m
	5829	SİNEKLİK KANAT PROFİLİ SCREENING SASH PROFILE	-	-	0,655 kg/m
	12339	SİNEKLİK KANAT PROFİLİ SCREENING SASH PROFILE	-	-	0,703 kg/m
	9780	SİNEKLİK KANAT PROFİLİ SCREENING SASH PROFILE	-	-	0,860 kg/m
	5851	SABİT KASA PROFİLİ FIXED FRAME PROFILE	-	-	0,971 kg/m
	5850	ORTA KAYIT PROFİLİ MULLION PROFILE	-	-	0,842 kg/m
	12657	KAPAK PROFİLİ COVER PROFILE	-	-	0,414 kg/m
	5832	ADAPTÖR PROFİLİ ADAPTER PROFILE	-	-	0,436 kg/m
	9781	SİNEKLİK KAPAK PROFİLİ SCREENING COVER PROFILE	-	-	0,211 kg/m
	3594	TAKVİYE PROFİLİ REINFORCE PROFILE	-	-	0,456 kg/m
	3595	TAKVİYE KAPAK PROFİLİ REINFORCE COVER PROFILE	-	-	0,101 kg/m
	5821	SİNEKLİK RAY PROFİLİ SCREENING RAIL PROFILE	-	-	0,220 kg/m
	5844	KAPAK PROFİLİ COVER PROFILE	-	-	0,103 kg/m
	5845	TİJ PROFİLİ STEM BAR PROFILE	-	-	0,141 kg/m
	598	KÖŞE KANAT PROFİLİ CORNER WEDGE PROFILE	-	-	1,677 kg/m

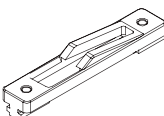
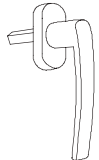
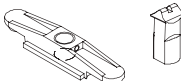
** Her profil için minimum sipariş 300 kg'dır.
** Minimum order quantity is 300 kg per profile.

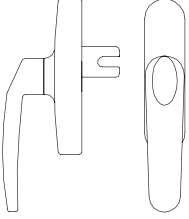
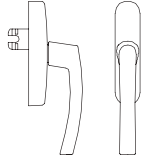
AKSESUAR ACCESSORY	STOK KODU REFERENCE CODE	AKSESUAR ADI DESCRIPTION	AKSESUAR KODU PRODUCT CODE	PAKET PACK
	03 010615	KANAL KAPATMA FİTİLİ RAIL COVER GASKET	S35-KRF.05	330 mt / paket 10 kg
	03 010613	KENET SÜSPANSİYON FİTİLİ INTERLOCKING SUSPANSION GASKET	S35-KRF.04	770 mt / paket 10 kg
	03 010503	DIŞ CAM FİTİLİ OUTER GLAZING GASKET	S35-DCF.30	215 mt / paket 10 kg
	03 011230	İÇ CAM FİTİLİ INNER GLAZING GASKET	S35-ICF.30	280 mt / paket 10 kg
	03 011231	İÇ CAM FİTİLİ INNER GLAZING GASKET	S35-ICF.40	220 mt / paket 10 kg
	03 010732	İÇ CAM FİTİLİ INNER GLAZING GASKET	S35-ICF.50	185 mt / paket 10 kg
	01 200400	KANAT KÖŞE BAĞLANTI SASH CORNER JOINT	S35-KKB.400	100 ad / paket
	01 200401	KENET KÖŞE BAĞLANTI INTERLOCKING CORNER JOINT	S35-KKB.401	100 ad / paket
	01 200402	KENET KÖŞE BAĞLANTI (TERS) INTERLOCKING CORNER JOINT (SYMMETRY)	S35-KKB.402	100 ad / paket
	01 200411	KENET KAPAĞI INTERLOCKING PART	S35-KP.411	100 ad / paket
	01 200460	KANAT SABİTLEME TAKOZU SASH FIXING WEDGE	S35-KST.460	100 ad / paket
	01 200410	S35 STOPER S35 STOPPER	S35-STP.410	250 ad / paket
	01 200420	ALT HAVA KESİCİ BOTTOM AIR BLOCKER	S35-AHK.420	4 ad / paket
	01 200470	ÜST HAVA KESİCİ TOP AIR BLOCKER	S35-ÜHK.470	1 ad / paket

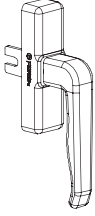
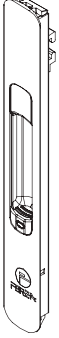
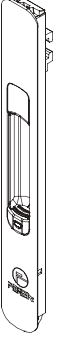
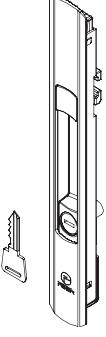
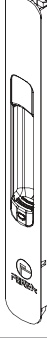
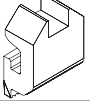
AKSESUAR ACCESSORY	STOK KODU REFERENCE CODE	AKSESUAR ADI DESCRIPTION	AKSESUAR KODU PRODUCT CODE	PAKET PACK
	01 200430	TAKVİYELİ KENET KAPAĞI REINFORCED INTERLOCKING COVER <small>5831 profili ile çalıştır / For 5831</small>	S35-TKK.430	100 ad / paket
	01 200431	TAKVİYELİ KENET KAPAĞI REINFORCED INTERLOCKING COVER	S35-TKK.431	100 ad / paket
	01 200491	İSPANYOLET (40 cm) ESPAGNOLETTE (40 cm)	S35-ISP.491	1 ad / paket
	01 200493	İSPANYOLET (80 cm) ESPAGNOLETTE (80 cm)	S35-ISP.493	1 ad / paket
	01 200494	İSPANYOLET (100 cm) ESPAGNOLETTE (100 cm)	S35-ISP.494	1 ad / paket
	01 200492	İSPANYOLET (120 cm) ESPAGNOLETTE (120 cm)	S35-ISP.492	1 ad / paket
	01 200496	İSPANYOLET (140 cm) ESPAGNOLETTE (140 cm)	S35-ISP.496	1 ad / paket
	01 200497	İSPANYOLET (160 cm) ESPAGNOLETTE (160 cm)	S35-ISP.497	1 ad / paket
	01 200498	İSPANYOLET (180 cm) ESPAGNOLETTE (180 cm)	S35-ISP.498	1 ad / paket
	01 200440	İSPANYOLET KARŞILIK ESPAGNOLETTE STRIKER	S35-İK.440	1 pk / 25 ad
	01 200291	ROTO SECUSTİK PENCERE KOLU ROTO WINDOW HANDLE	S35-RK.291	1 Pk / 20 ad
	01 200441	KANCA VE GÖVDE BODY SET	S35-GT.441	1 pk / 25 ad
	01 120100	İSPANYOLET PİMİ ESPAGNOLETTE PIN	S35-TP.100	1 pk / 100 ad
	01 020702	FORZA EKSENEL PENCERE KOL(BEYAZ) FORZA AXIAL WINDOW HANDLE(WHITE)	S35-FPK.702	1 pk / 20 ad
	01 020703	FORZA EKSENEL PENCERE KOL(RENKLİ) FORZA AXIAL WINDOW HANDLE(COLORED)	S35-FPK.703	1 pk / 20 ad
	01 020803	FORZA EKSENEL PENCERE KOL(NATUREL) FORZA WINDOW AXIAL HANDLE (NATURAL)	S35-FPK.803	1 pk / 20 ad
	01 020601	EKSENEL KOL ROTO(ELOKSALLI) ROTO AXIAL HANDLE(ANODIZED)	S35-RK.601	1 pk / 10 ad
	01 020604	EKSENEL KOL ROTO(ELOKSALLI KİLİTLİ) ROTO AXIAL HANDLE(ANODIZED LOCKED)	S35-RK.604	1 pk / 10 ad

AKSESUAR ACCESSORY	STOK KODU REFERENCE CODE	AKSESUAR ADI DESCRIPTION	AKSESUAR KODU PRODUCT CODE	PAKET PACK
	01 020810	FORZA EKSENEL KOL YENİ(NATUREL) FORZA NEW AXIAL HANDLE(NATURAL)	S35-EK.810	1 pk ./50 ad
	01 020811	FORZA EKSENEL KOL YENİ(BEYAZ) FORZA NEW AXIAL HANDLE(WHITE)	S35-EK.811	1 pk ./50 ad
	01 020812	FORZA EKSENEL KOL YENİ(RENKLI) FORZA NEW AXIAL HANDLE(COLOURED)	S35-EK.812	1 pk ./50 ad
	01 050750	FORZA YAYLI HAVUZ KOL (SİYAH) FORZA RECESSED HANDLE AUTOMATIC (BLACK)	S35-FHK.750	1 pk / 40ad
	01 050751	FORZA YAYLI HAVUZ KOL (BEYAZ) FORZA RECESSED HANDLE AUTOMATIC (WHITE)	S35-FHK.751	1 pk / 40ad
	01 050752	FORZA YAYLI HAVUZ KOL (NATUREL) FORZA RECESSED HANDLE AUTOMATIC (NATURAL)	S35-FHK.752	1 pk / 40ad
	01 050753	FORZA YAYLI HAVUZ KOL (ANTRASİT) FORZA RECESSED HANDLE AUTOMATIC (ANTHRACITE)	S35-FHK.753	1 pk / 40ad
	01 050760	FORZA MANUEL HAVUZ KOL (SİYAH) FORZA RECESSED HANDLE MANUEL (BLACK)	S35-FHK.760	1 pk / 40ad
	01 050761	FORZA MANUEL HAVUZ KOL(BEYAZ) FORZA RECESSED HANDLE MANUEL (WHITE)	S35-FHK.761	1 pk / 40ad
	01 050762	FORZA MANUEL HAVUZ KOL (NATUREL) FORZA RECESSED HANDLE MANUEL (NATURAL)	S35-FHK.762	1 pk / 40ad
	01 050763	FORZA MANUEL HAVUZ KOL (ANTRASİT) FORZA RECESSED HANDLE MANUEL (ANTHRACITE)	S35-FHK.763	1 pk / 40ad
	01 050770	FORZA ANAHTARLI HAVUZ KOL (SİYAH) FORZA RECESSED HANDLE LOCK WITH KEY (BLACK)	S35-FHK.770	1 pk / 40ad
	01 050771	FORZA ANAHTARLI HAVUZ KOL (BEYAZ) FORZA RECESSED HANDLE LOCK WITH KEY (WHITE)	S35-FHK.771	1 pk / 40ad
	01 050772	FORZA ANAHTARLI HAVUZ KOL (NATUREL) FORZA RECESSED HANDLE LOCK WITH KEY (NATURAL)	S35-FHK.772	1 pk / 40ad
	01 050773	FORZA ANAHTARLI HAVUZ KOL (ANTRASİT) FORZA RECESSED HANDLE LOCK WITH KEY (ANTHRACITE)	S35-FHK.773	1 pk / 40ad
	01 050790	FORZA PASİF HAVUZ KOL (SİYAH) FORZA RECESSED FINGER PULL HANDLE (BLACK)	S35-FHK.790	1 pk / 40 ad
	01 050791	FORZA PASİF HAVUZ KOL (BEYAZ) FORZA RECESSED FINGER PULL HANDLE (WHITE)	S35-FHK.791	1 pk / 40 ad
	01 050792	FORZA PASİF HAVUZ KOL (NATUREL) FORZA RECESSED FINGER PULL HANDLE (NATURAL)	S35-FHK.792	1 pk / 40 ad
	01 050793	FORZA PASİF HAVUZ KOL (ANTRASİT) FORZA RECESSED FINGER PULL HANDLE (NATURAL)	S35-FHK.793	1 pk / 40 ad
	01 050781	FORZA KİLİT DİLİ (ZAMAK) FORZA HOOK (ZAMAK) Forza yaylı ve manuel havuz kol ile kullanılmaktadır.	S35-FKD.781	1 pk / 40 ad
	01 050780	FORZA KİLİT DİLİ (ZAMAK) FORZA HOOK (ZAMAK)	S35-FKD.780	1 pk / 40 ad

AKSESUAR ACCESSORY	STOK KODU REFERENCE CODE	AKSESUAR ADI DESCRIPTION	AKSESUAR KODU PRODUCT CODE		PAKET PACK
	01 050782	FORZA KİLİT KARŞILIĞI (ZAMAK) FORZA STRIKER (ZAMAK)	S35-FKK.782		1 pk / 40 ad
	04 010200	PASLANMAZ ÇELİK RAY 8,3mm STAINLESS STEEL RAIL 8.3 mm	S35-PÇR.200		10 ad x 6 m
	01 200450	S35 ELİT ALÜMİNYUM AYARLI RULMAN S35 ELITE ALUMINIUM ADJUSTABLE ROLLER	S35-AR.450	250 KG	1 pk / 100 ad
	01 200455	S35 FORZA ECO ALÜMİNYUM AYARLI RULMAN S35 FORZA ECO ALUMINIUM ADJUSTABLE ROLLER	S35-FAR.455	130 KG	1 pk / 100 ad
	01 130307	ALYAN KÖŞE BAĞLANTI ALLEN CORNER JOINT	S35-MC.307		1 pk / 250 ad
	04 100121	AYARLI TEKLİ RULMAN (PVC) ADJUSTABLE ROLLER (SINGLE)	S35-AR.121		1 pk / 100 ad
	04 100120	SAC KÖŞE BAĞLANTI SHEET CORNER CONNECTION	S35-SC.150		1 pk / 500 ad
	03 050709	FIRÇA FİTİL WEATHER STRIP	S35-FÇ.709		350 m / paket
	03 050711	FIRÇA FİTİL WEATHER STRIP	S35-FÇ.711		250 m / paket
	04 060080 - 80cm	SİNEKLİK TÜLÜ SCREENING NET	S35-STF.80		24 m ² / paket
	04 060100 - 100cm		S35-STF.100		30 m ² / paket
	04 060120 - 120cm		S35-STF.120		36 m ² / paket
	04 060140 - 140cm		S35-STF.140		44 m ² / paket
	04 060160 - 160cm		S35-STF.160		48 m ² / paket
	03 020114	SİNEKLİK FİTİLİ SCREENING GASKET	S35-SF.114		1 pk / 100 m
	03 020115		S35-SF.115		
	03 020116		S35-SF.116		
	02 020260	S35 OTOMATİK PUNCH MAKİNESİ S35 AUTOMATIC PUNCHING MACHINE	S35- PH.260		1 pk / 1 ad

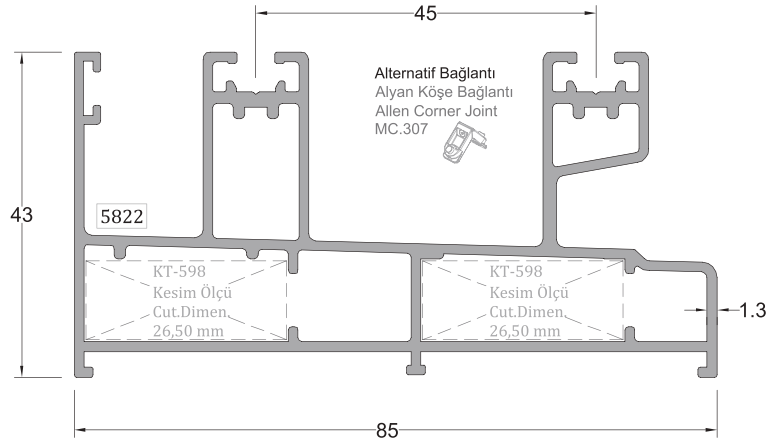

İki Raylı Kasa Profili DOUBLE RAIL FRAME PROFILE	Profil Kodu Profile Code	(kg/mt) Weight	Jx cm ⁴	Jy cm ⁴
	5822	1,488	9,45	38,88

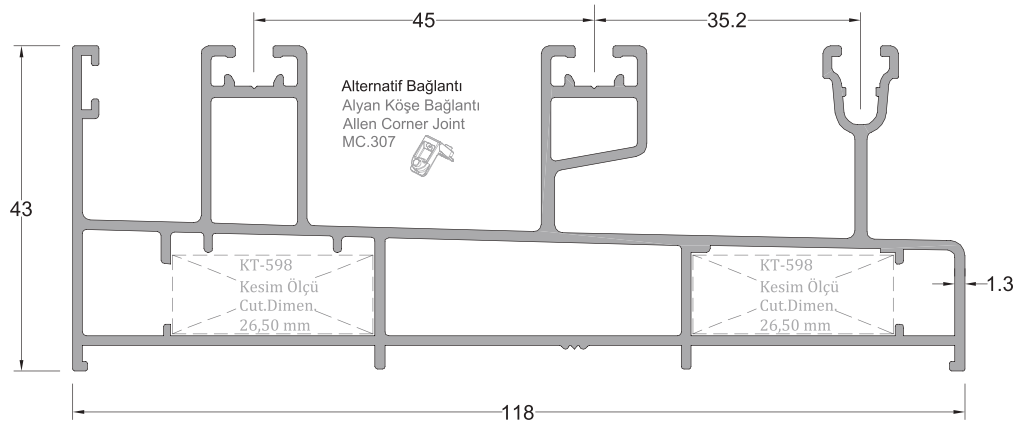

İki Raylı Sineklikli Kasa Profili DOUBLE RAIL SCREENING FRAME PROFILE	Profil Kodu Profile Code	(kg/mt) Weight	Jx cm ⁴	Jy cm ⁴
	11597	1,885	11,54	91,54

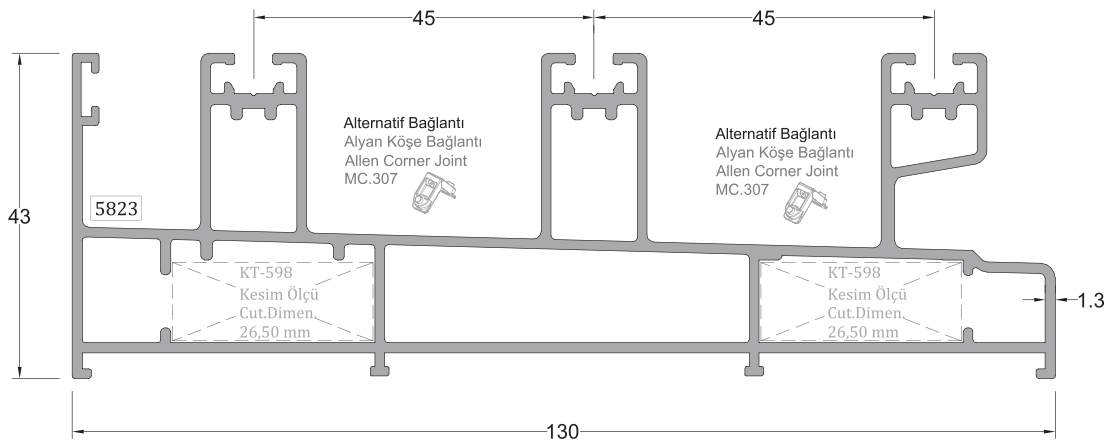

Üç Raylı Kasa Profili TRIPLE RAIL FRAME PROFILE	Profil Kodu Profile Code	(kg/mt) Weight	Jx cm ⁴	Jy cm ⁴
	5823	2,145	13,55	129,96

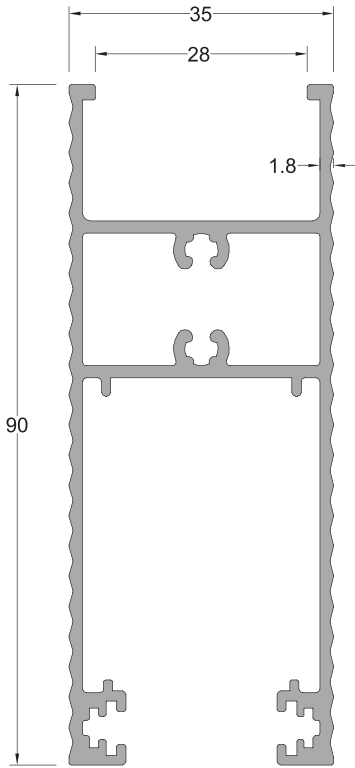

Kanat Profili SASH PROFILE	Profil Kodu Profile Code	(kg/mt) Weight	Jx cm ⁴	Jy cm ⁴
	5825	1,331	34,99	9,77

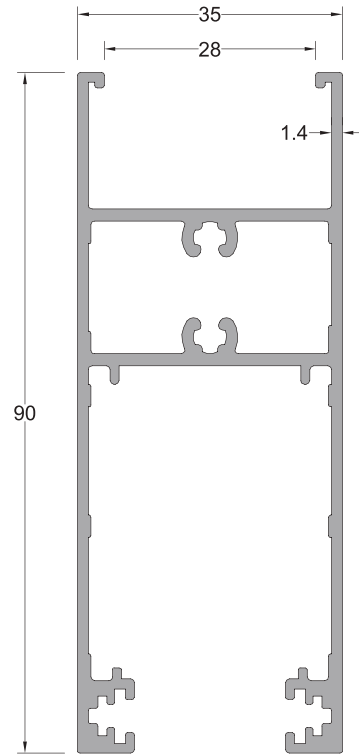

Kanat Profili SASH PROFILE	Profil Kodu Profile Code	(kg/mt) Weight	Jx cm ⁴	Jy cm ⁴
	5848	1,311	34,63	9,81

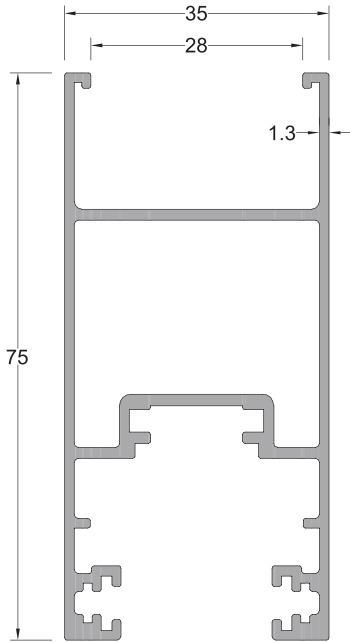

Kanat Profili SASH PROFILE	Profil Kodu Profile Code	(kg/mt) Weight	Jx cm ⁴	Jy cm ⁴
	5833	1,074	18,67	7,99

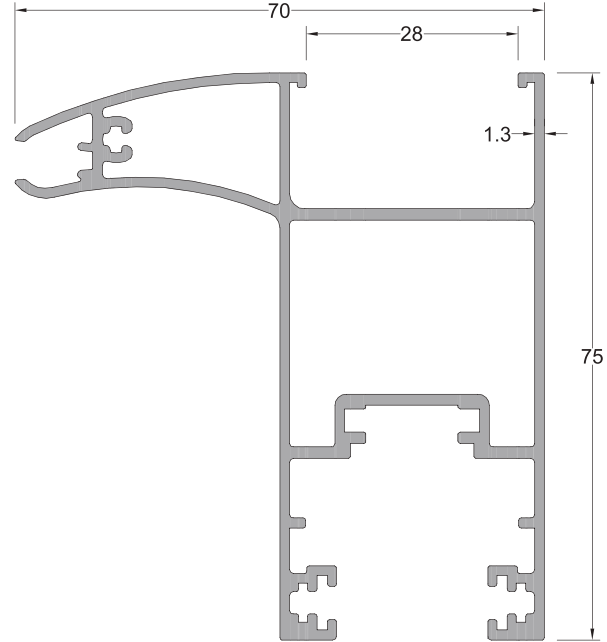

Kanat Profili SASH PROFILE	Profil Kodu Profile Code	(kg/mt) Weight	Jx cm ⁴	Jy cm ⁴
	5834	1,378	36,71	13,62

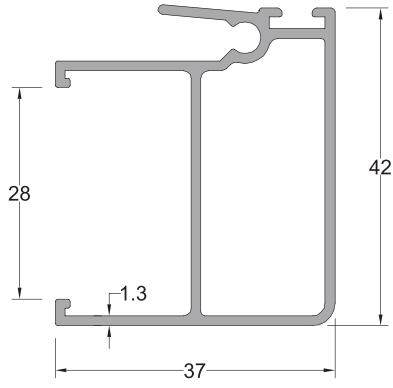

Kenet Profili INTERLOCK PROFILE	Profil Kodu Profile Code	(kg/mt) Weight	Jx cm ⁴	Jy cm ⁴
	5830	0,614	5,47	2,64

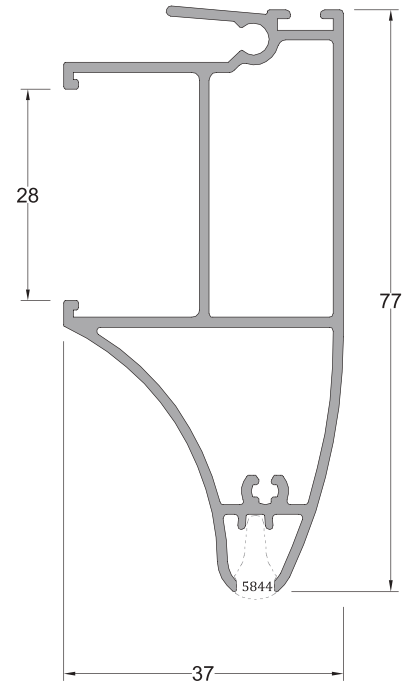

Kenet Profili INTERLOCK PROFILE	Profil Kodu Profile Code	(kg/mt) Weight	Jx cm ⁴	Jy cm ⁴
	5831	0,982	20,03	3,92

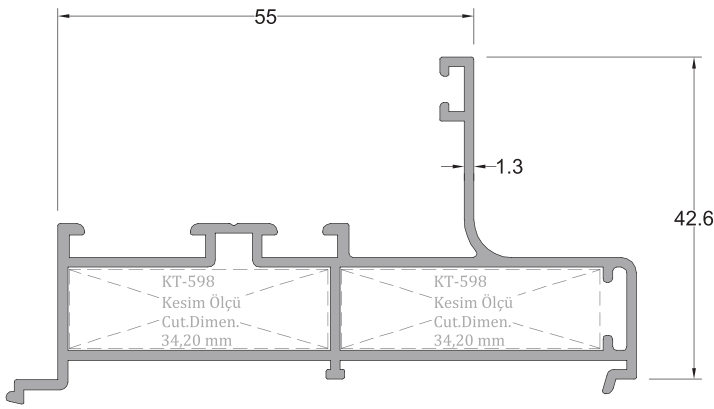

Sabit Kasa Profili FIXED FRAME PROFILE	Profil Kodu Profile Code	(kg/mt) Weight
	5851	0,971

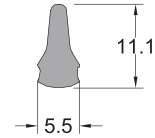

Kapak Profili COVER PROFILE	Profil Kodu Profile Code	(kg/mt) Weight
	5844	0,103

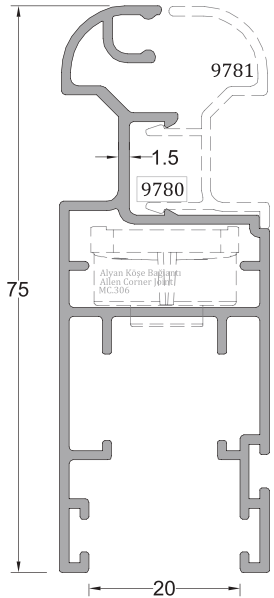

Sineklik Kanat Profili SWATTER SASH PROFILE	Profil Kodu Profile Code	(kg/mt) Weight
	9780	0,860

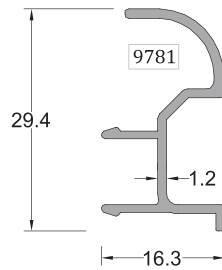

Sineklik Kapak Profili SCREENING COVER PROFILE	Profil Kodu Profile Code	(kg/mt) Weight
	9781	0,211

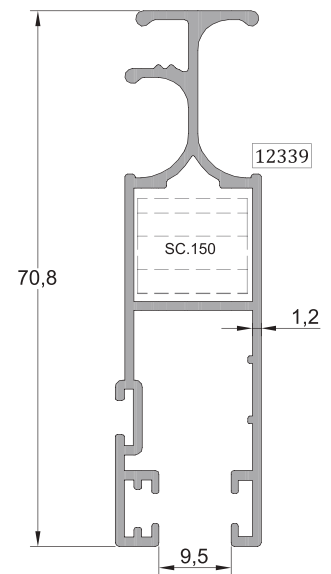

Sineklik Kanat Profili SCREENING SASH PROFILE	Profil Kodu Profile Code	(kg/mt) Weight
	12339	0,703

** Her profil için minimum sipariş 300 kg'dır.
** Minimum order quantity is 300 kg per profile.

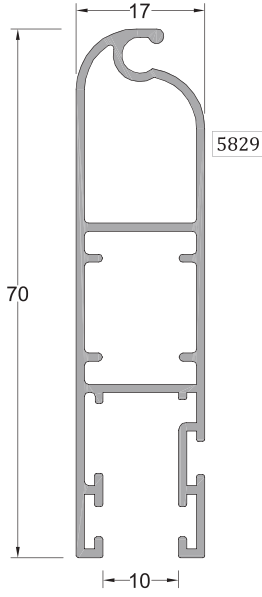

Sineklik Kanat Profili SWATTER SASH PROFILE	Profil Kodu Profile Code	(kg/mt) Weight
	1243	0,434

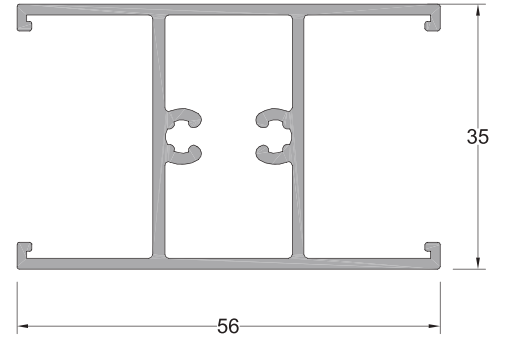
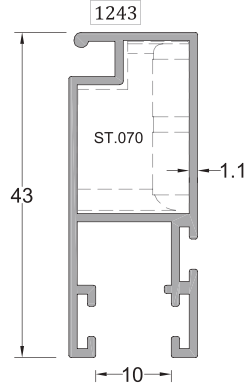

Orta Kayıt Profili MULLION PROFILE	Profil Kodu Profile Code	(kg/mt) Weight
	5850	0,842

Sineklik Kanat Profili SWATTER SASH PROFILE	Profil Kodu Profile Code	(kg/mt) Weight
	5829	0,655

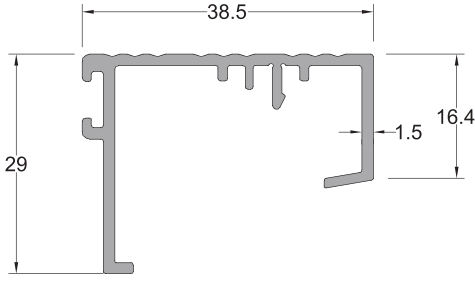

Kapak Profili COVER PROFILE	Profil Kodu Profile Code	(kg/mt) Weight
	12657	0,414

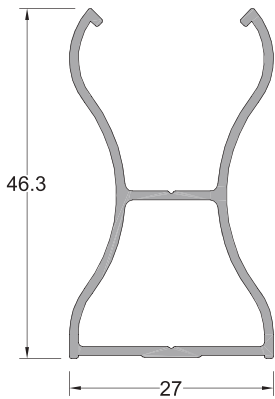
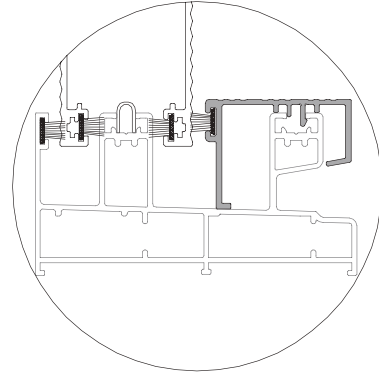

Takviye Profili REINFORCE PROFILE	Profil Kodu Profile Code	(kg/mt) Weight
	3594	0,456

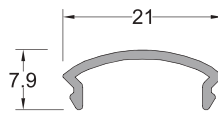

Takviye Kapak Profili REINFORCE COVER PROFILE	Profil Kodu Profile Code	(kg/mt) Weight
	3595	0,101

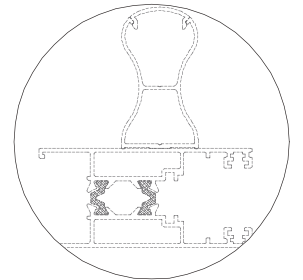

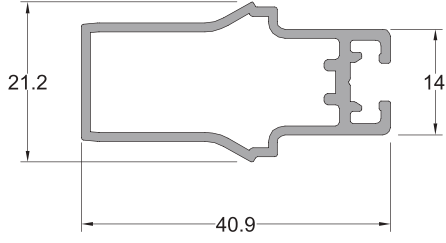

Adaptör Profili ADAPTER PROFILE	Profil Kodu Profile Code	(kg/mt) Weight
	5832	0,436

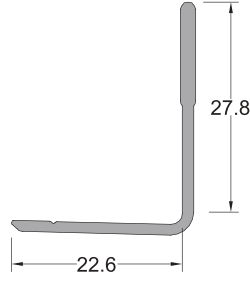

Sineklik Ray Profili SCREENING RAIL PROFILE	Profil Kodu Profile Code	(kg/mt) Weight
	5821	0,220

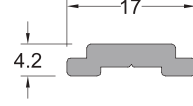

Tij Profili STEM BAR PROFILE	Profil Kodu Profile Code	(kg/mt) Weight
	5845	0,141

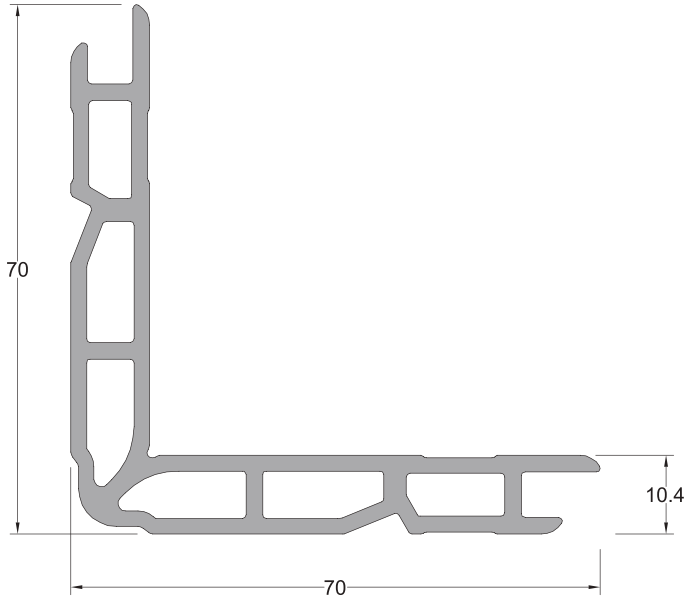

Köşe Takoz Profili CORNER WEDGE PROFILE	Profil Kodu Profile Code	(kg/mt) Weight
	598	1,677

Köşe Takozu Profil Kodu Corner Wedge Profile Code	Kullanıldığı Profil Compatible Profile	Kesim Boyu (mm) Cutting Length (mm)
598	5820,5822,5823	26,50 mm
	5851	34,20 mm

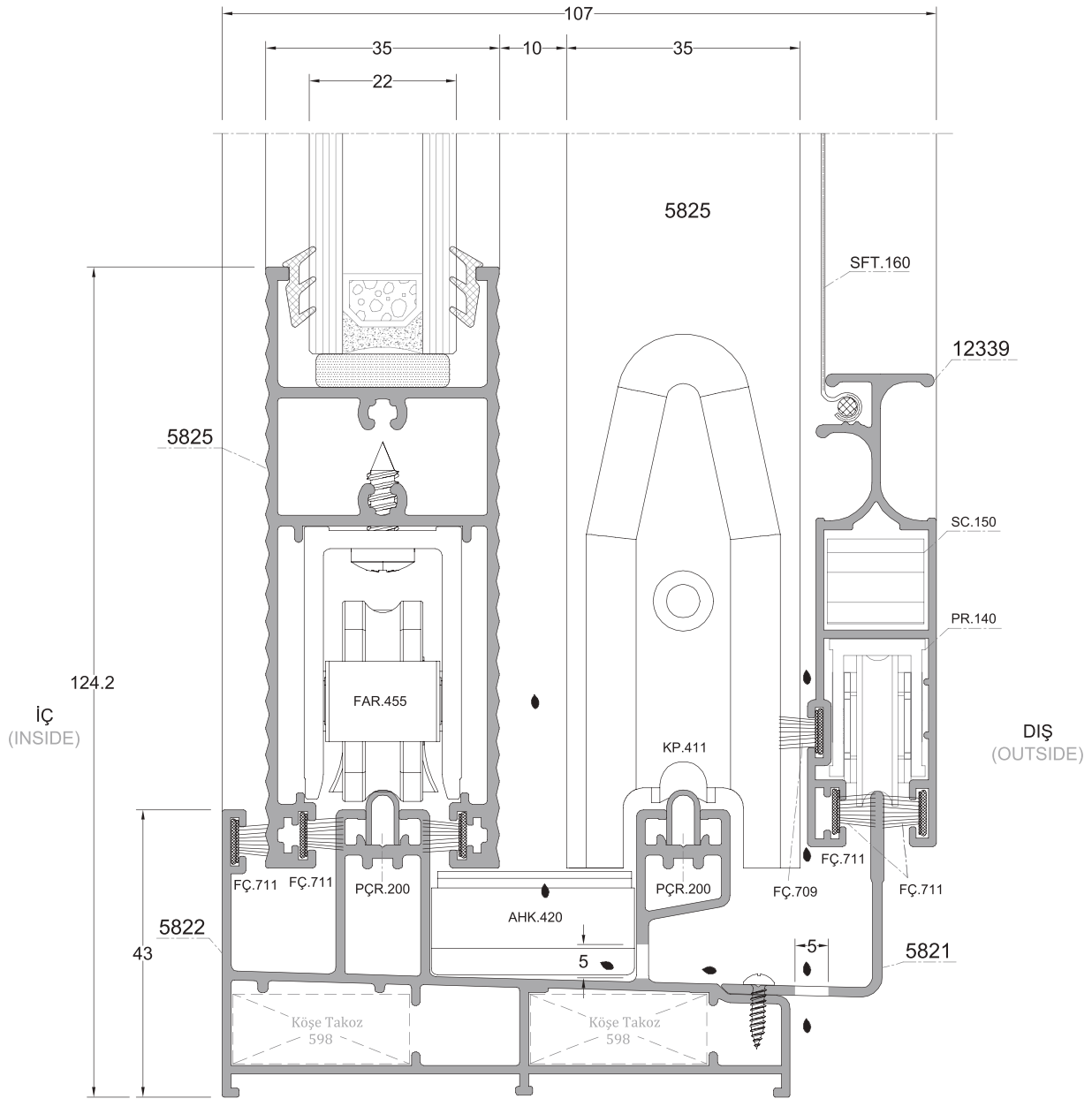
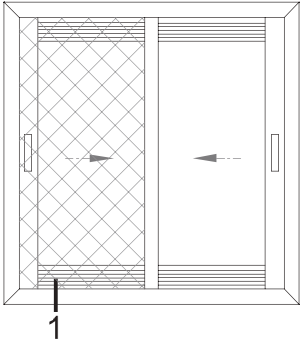

D-1

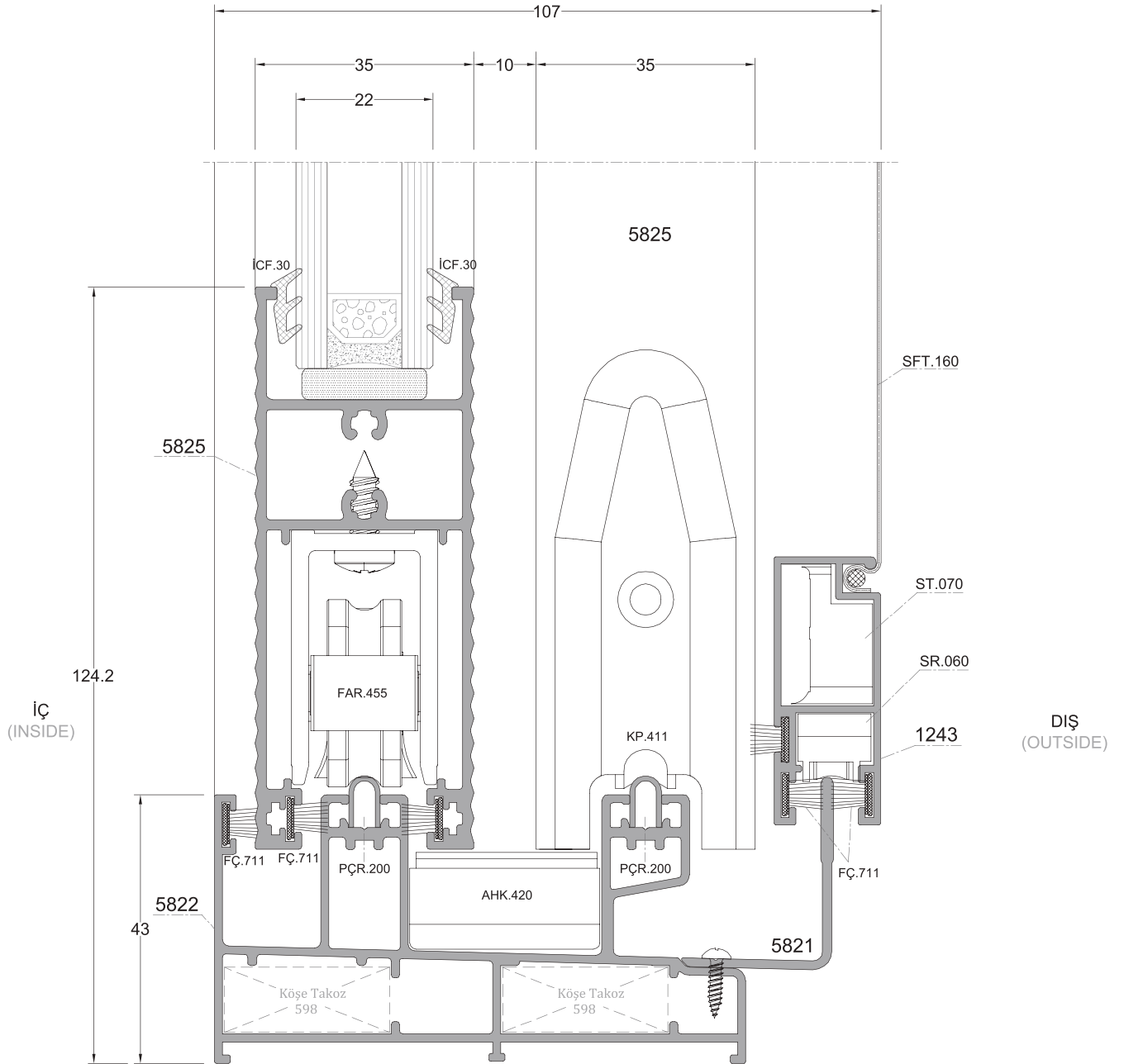
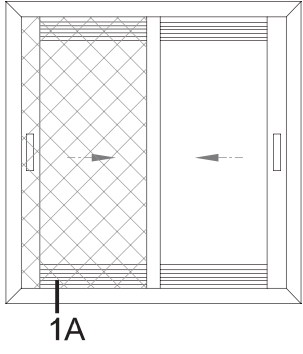

D-1A

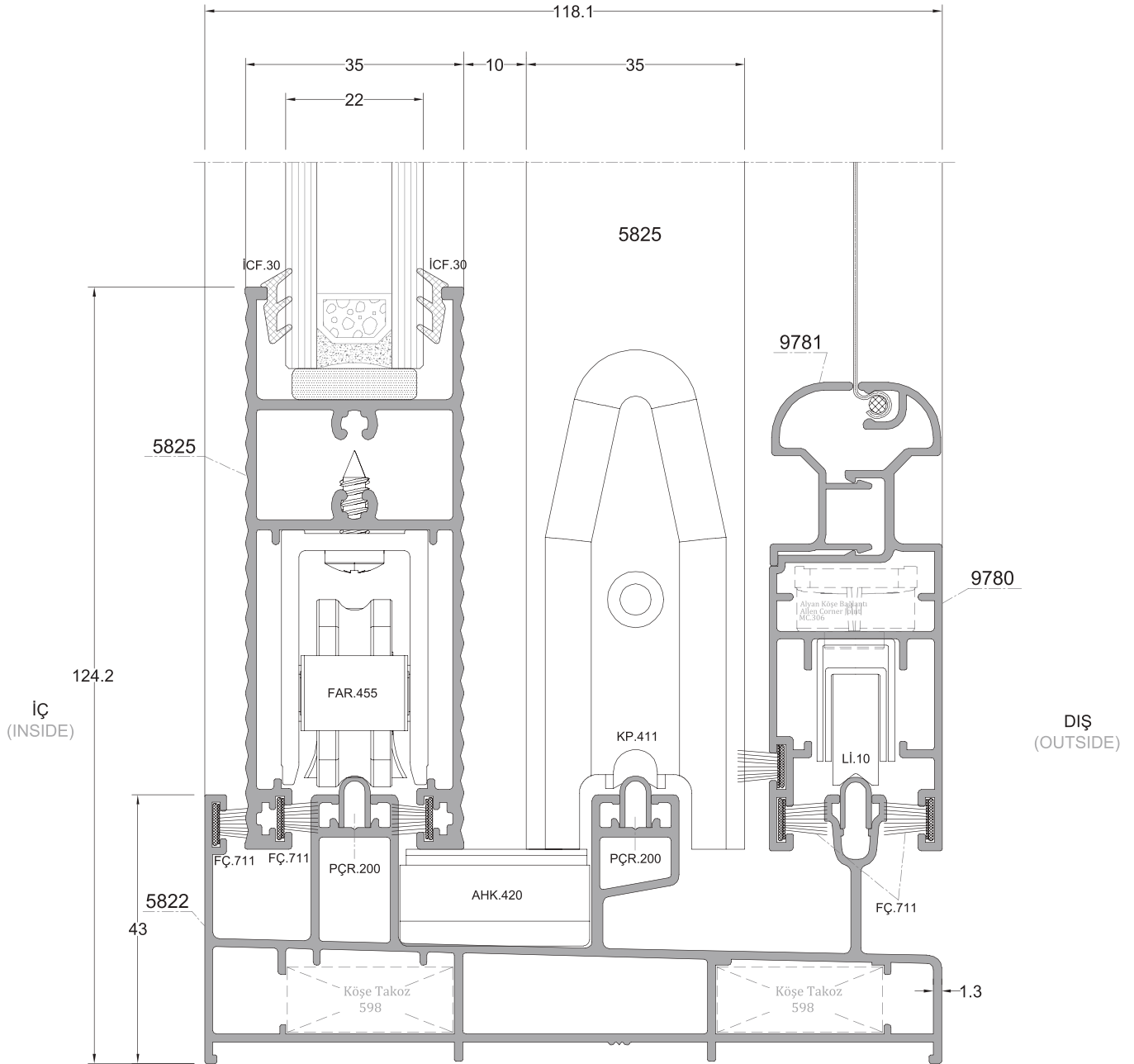
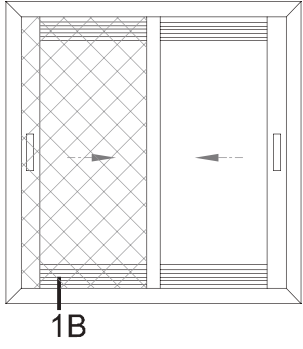

D-1B

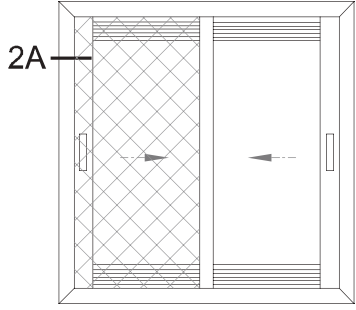

İÇ
(INSIDE)

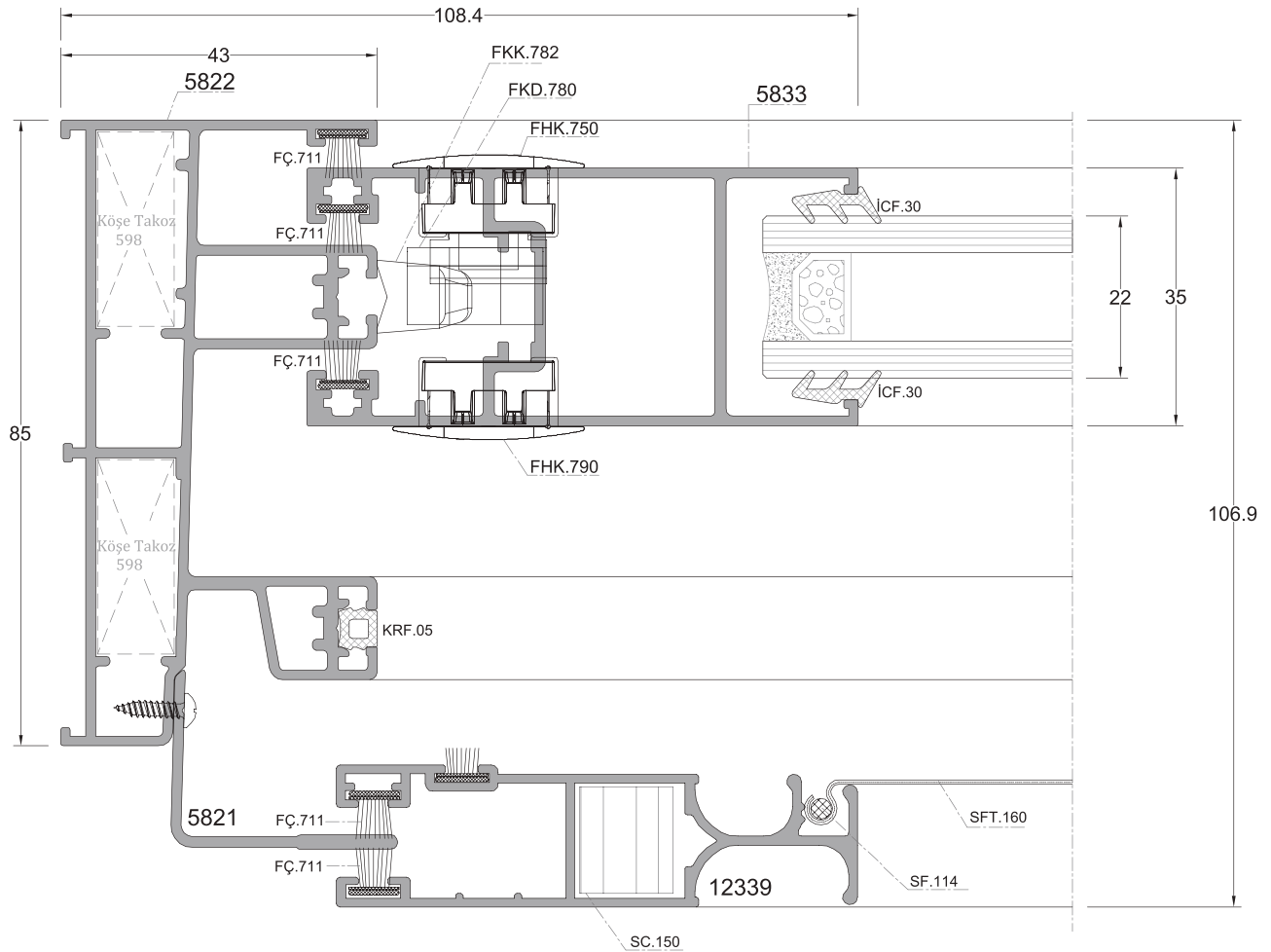

DIŞ
(OUTSIDE)

D-2A

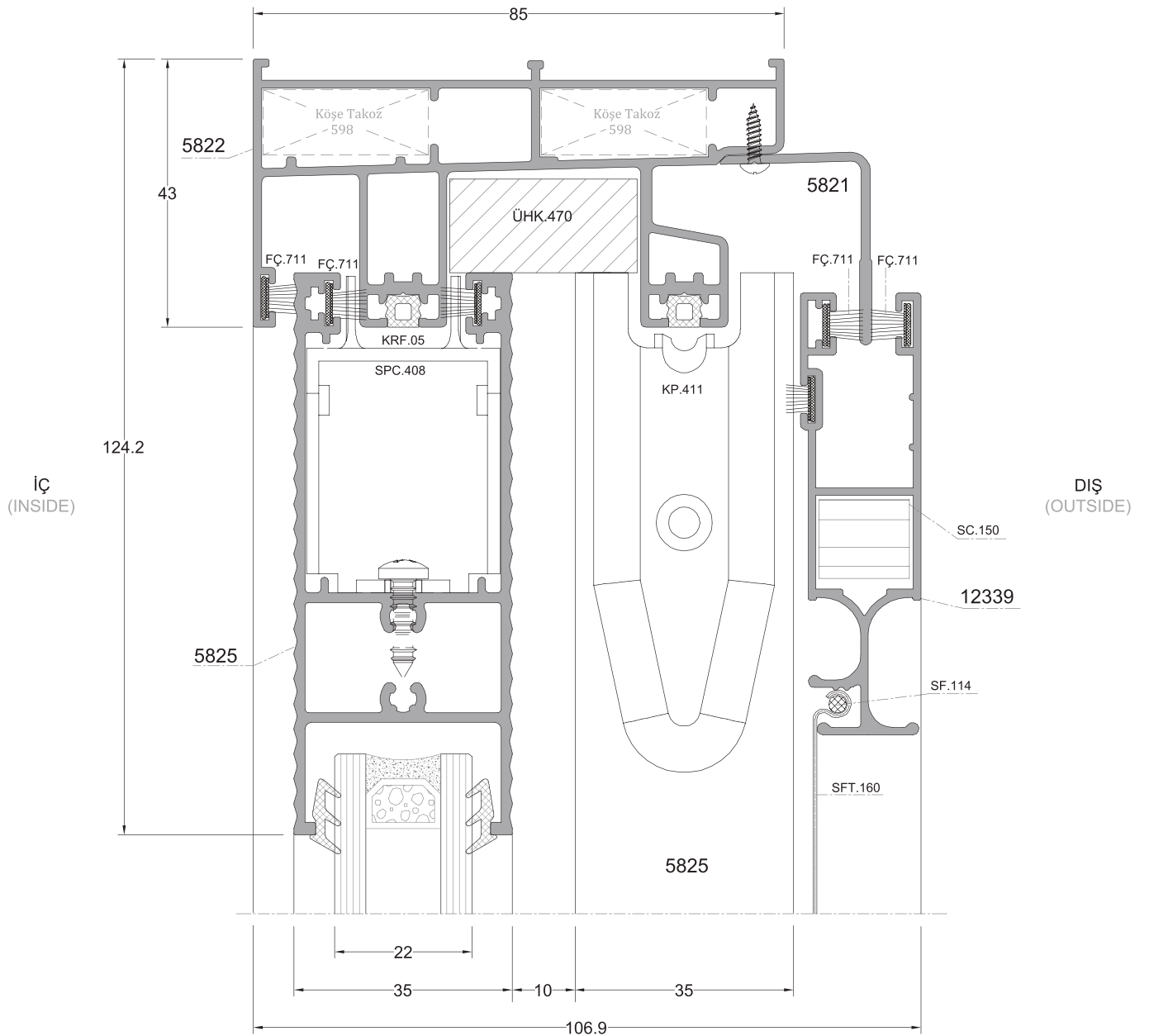
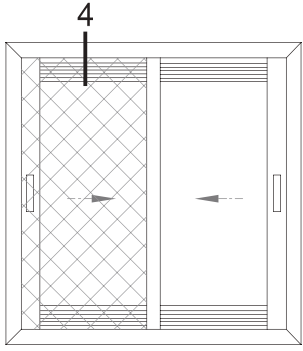

D-4

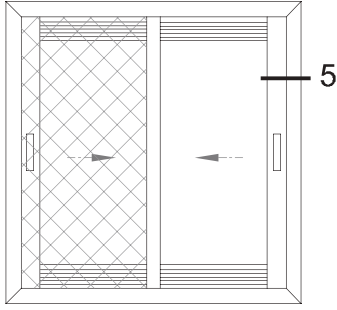

İÇ
(INSIDE)

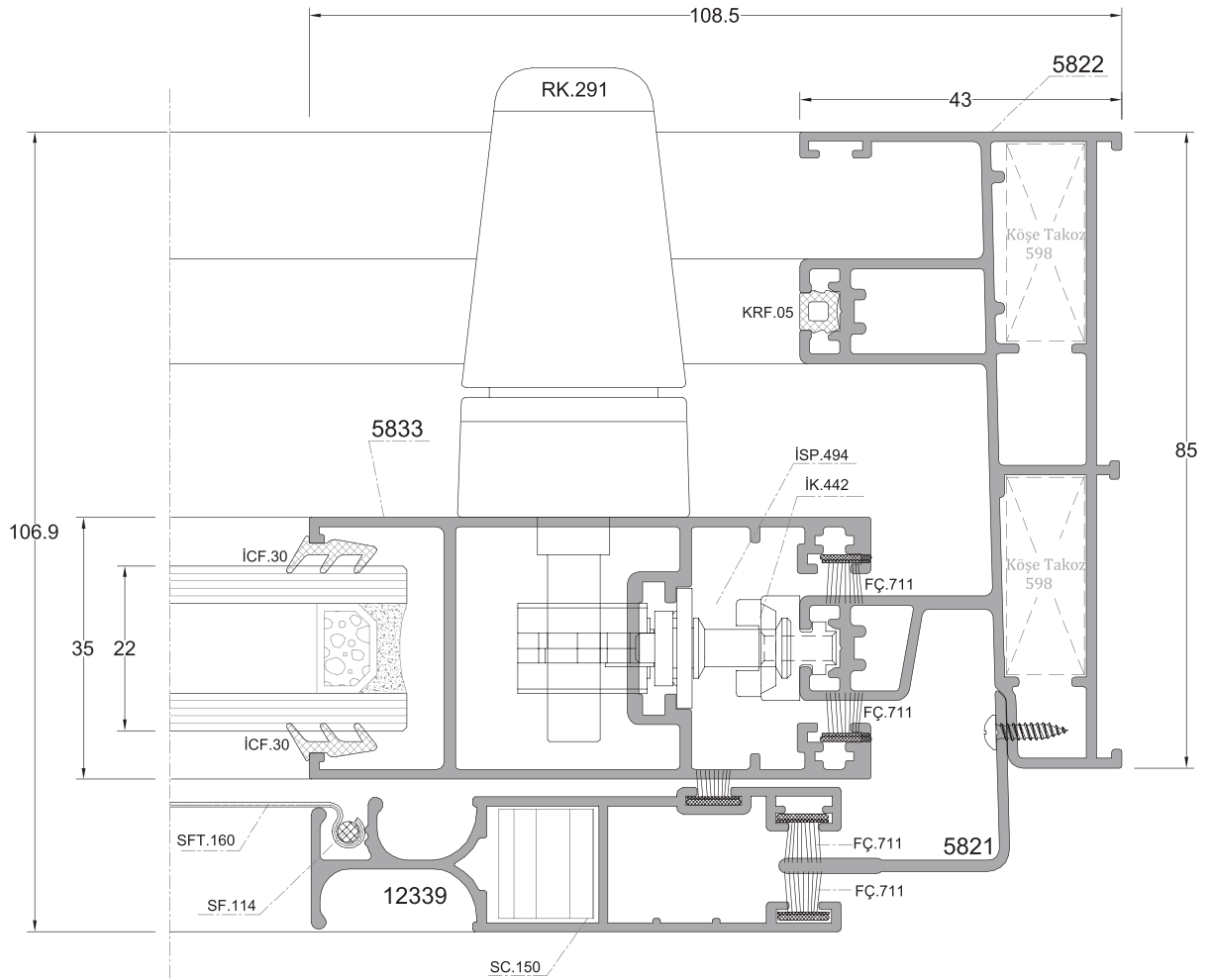

DIŞ
(OUTSIDE)

D-5

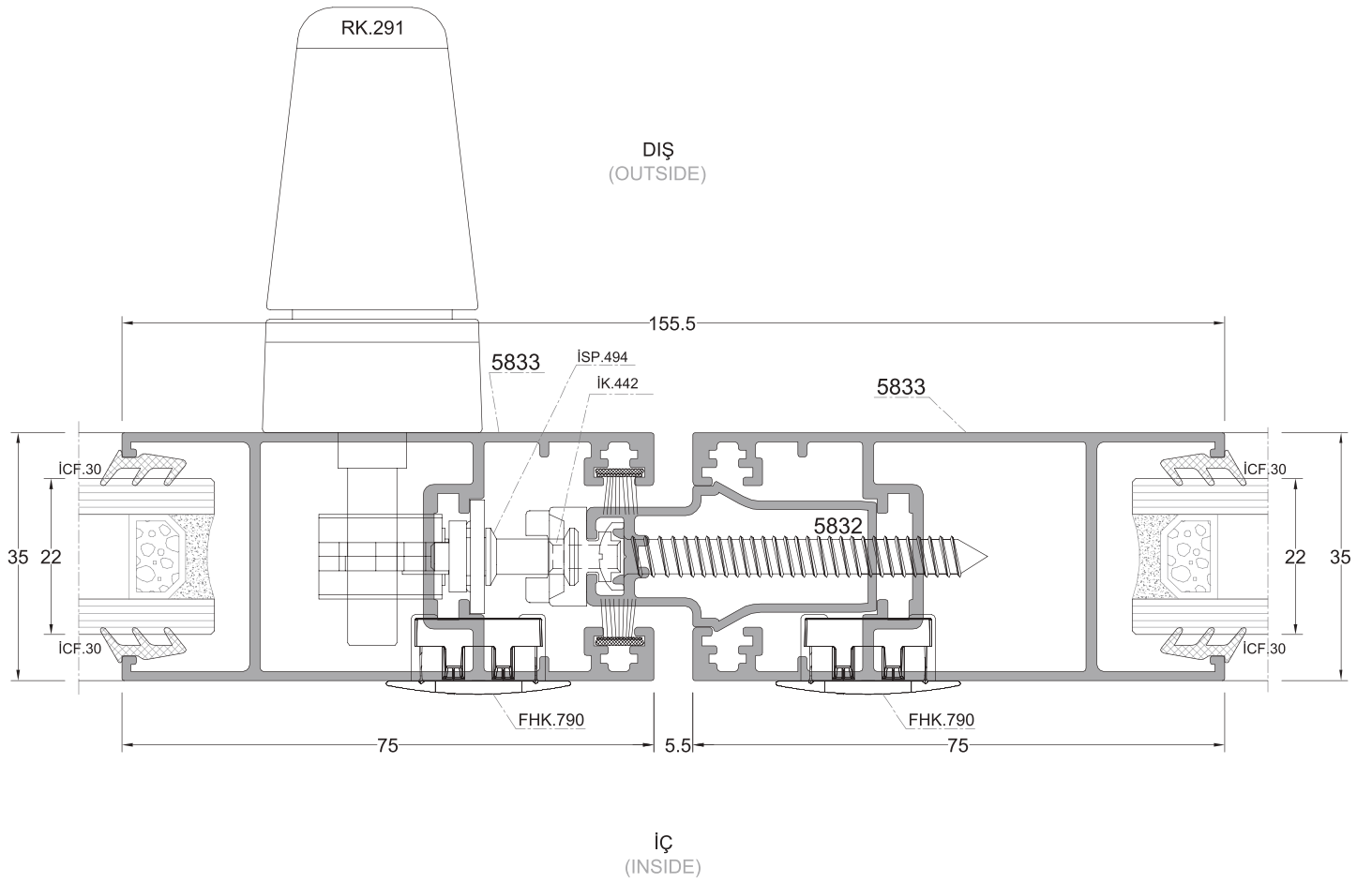
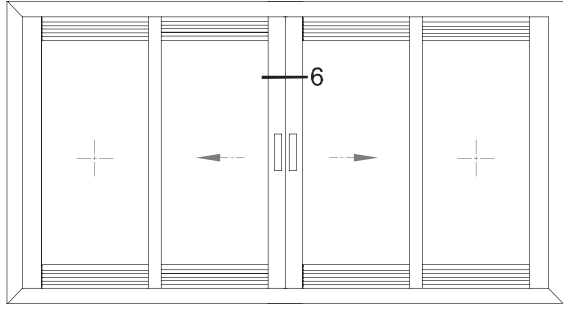

D-6

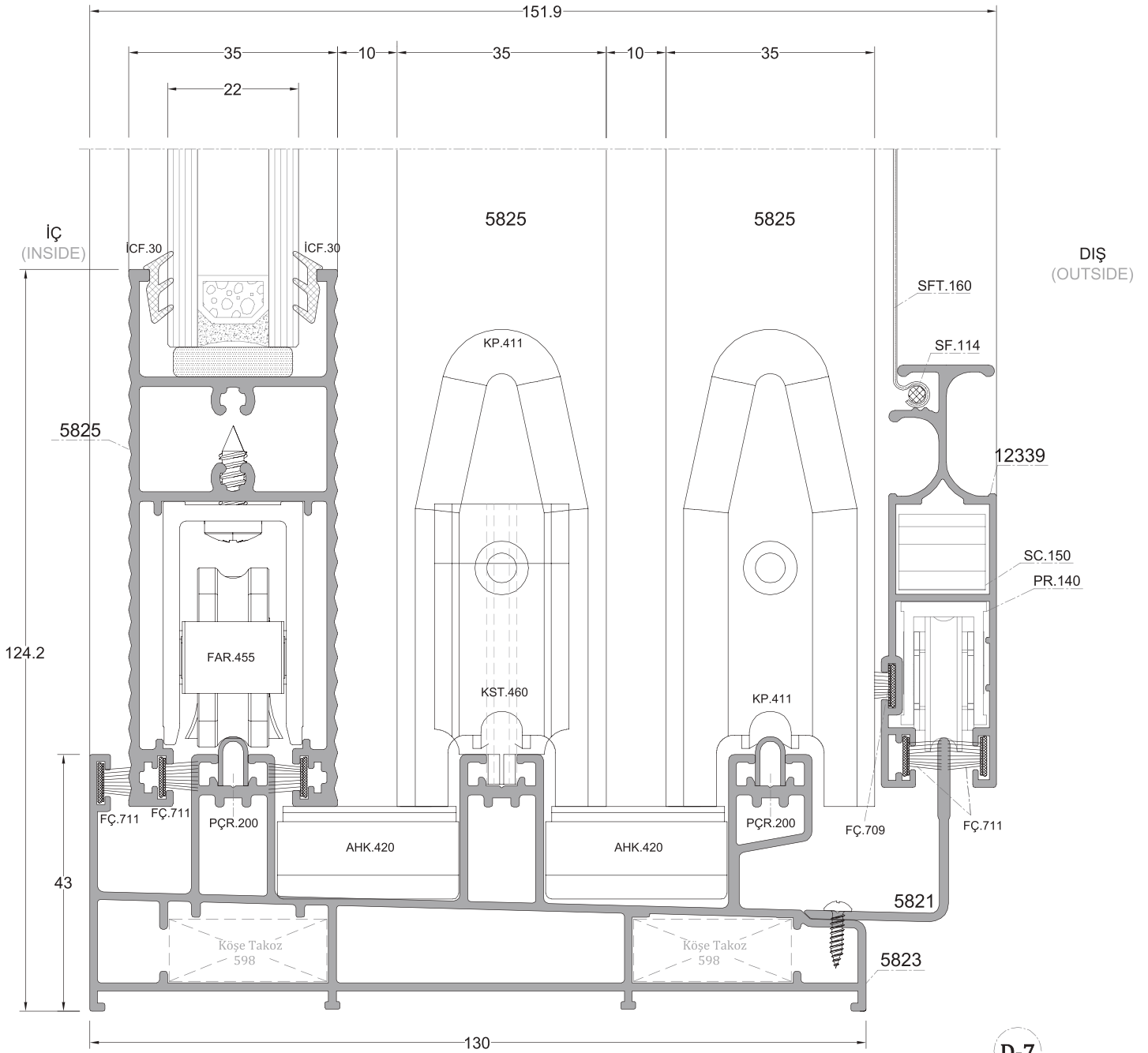
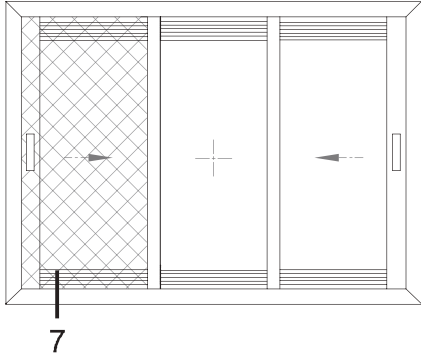

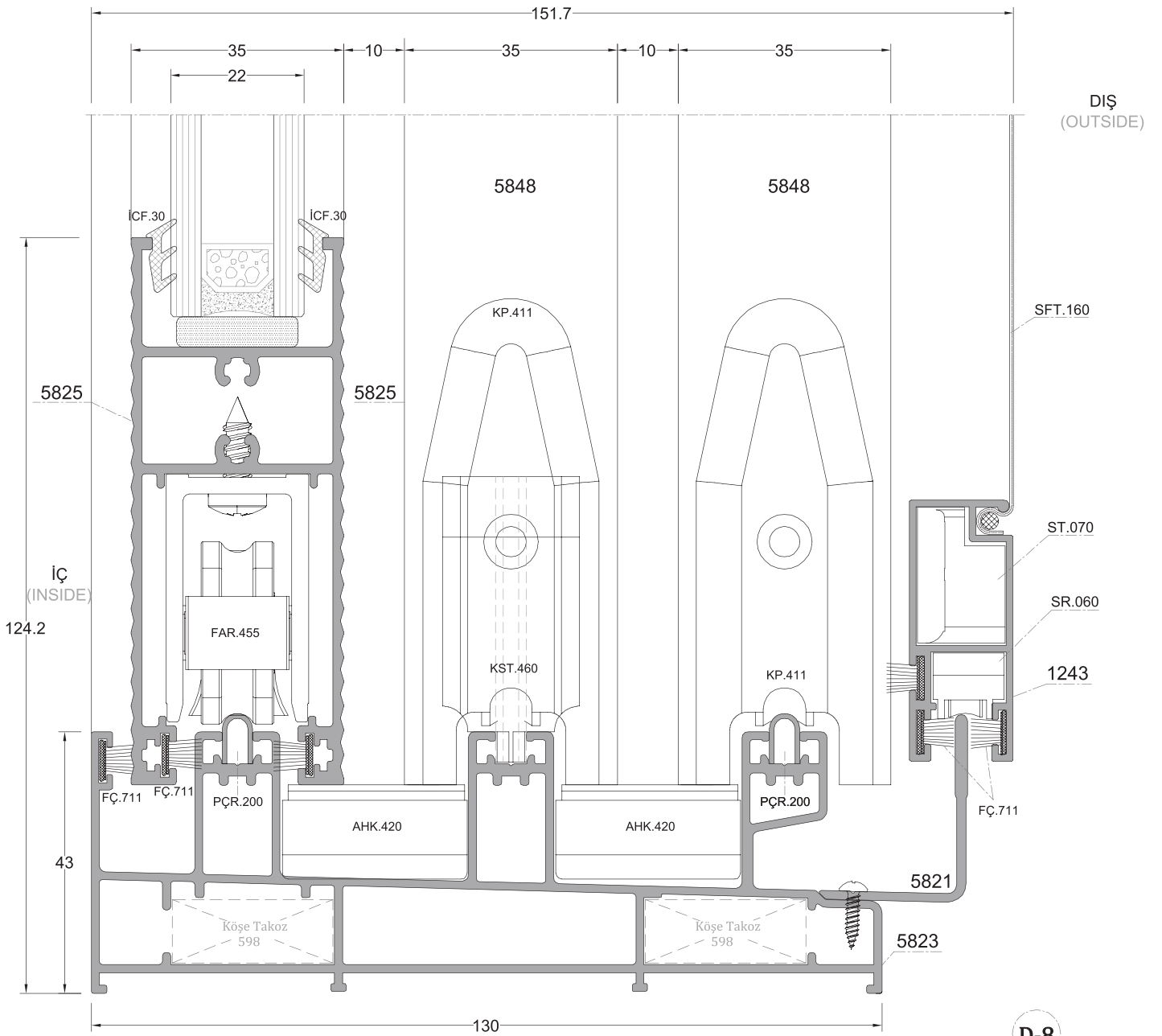
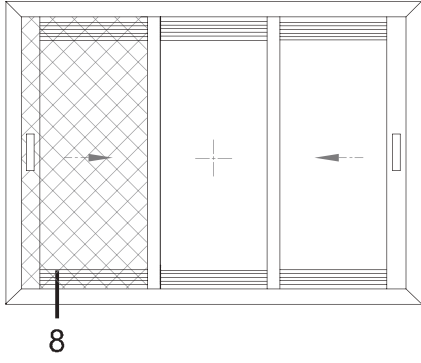

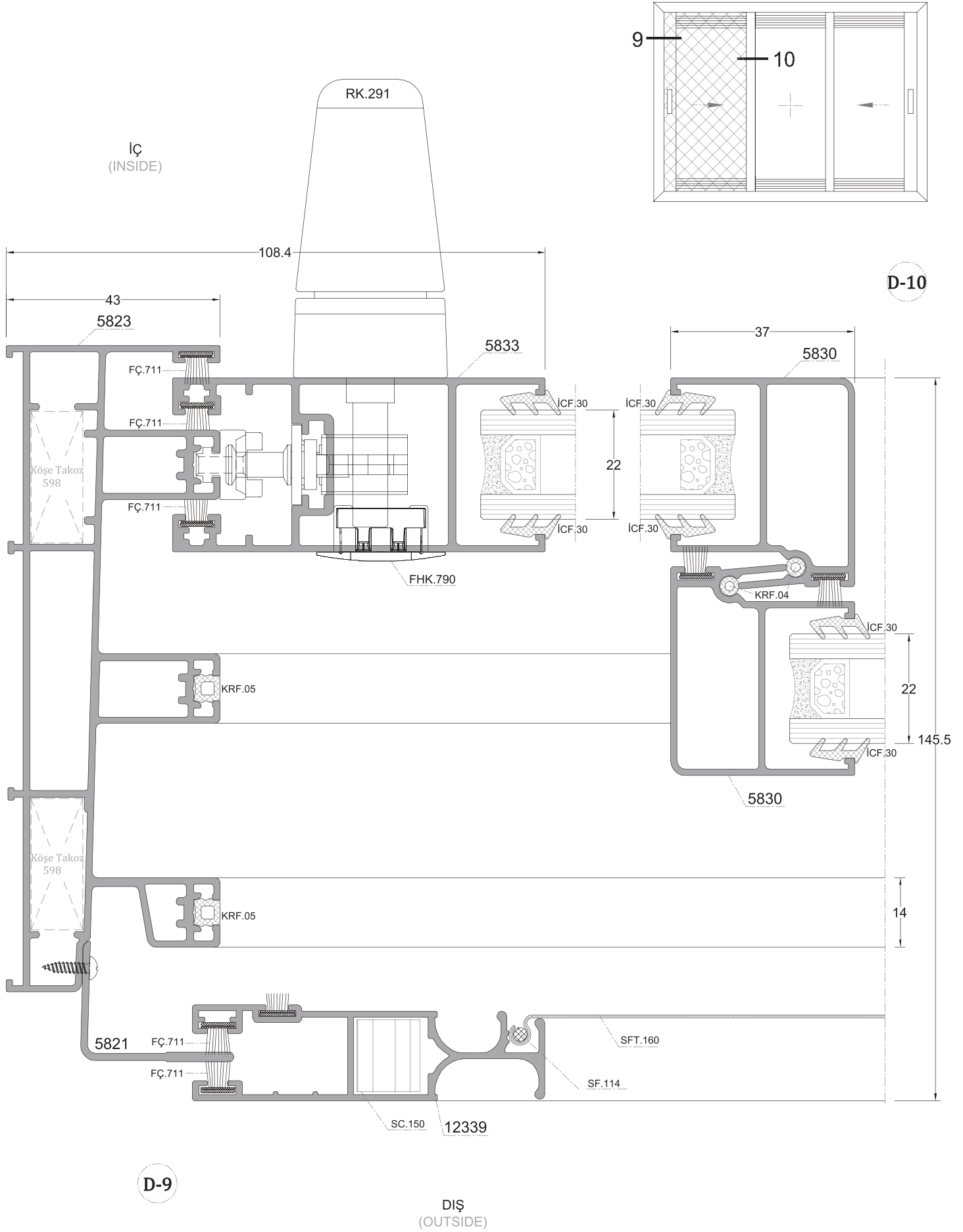

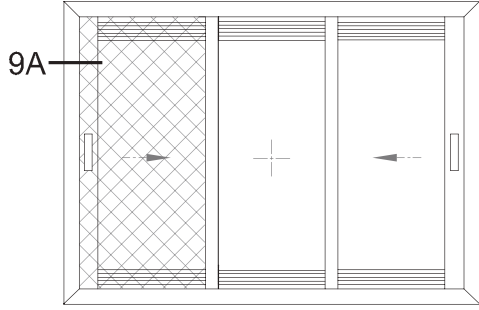

D-9A

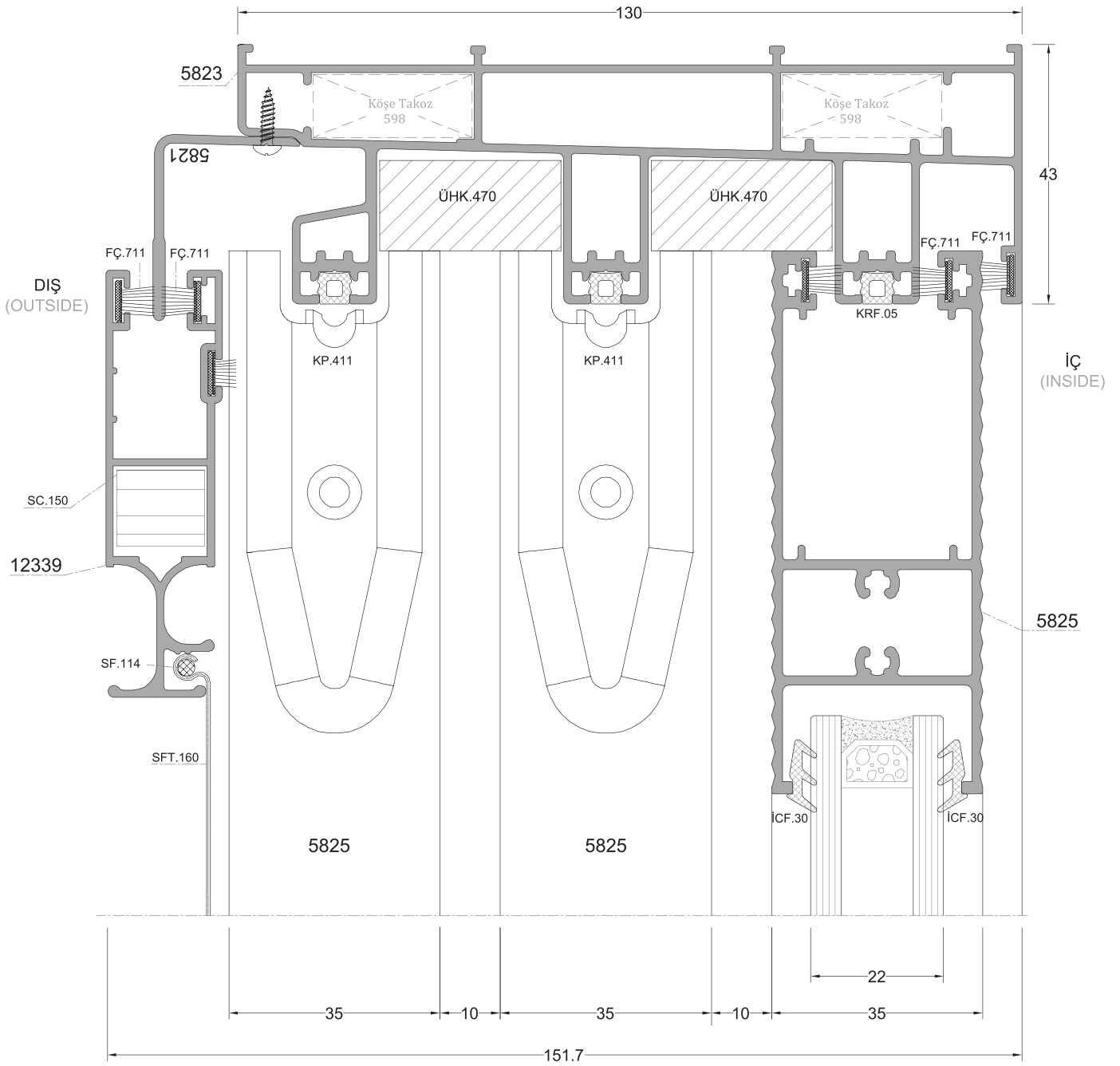
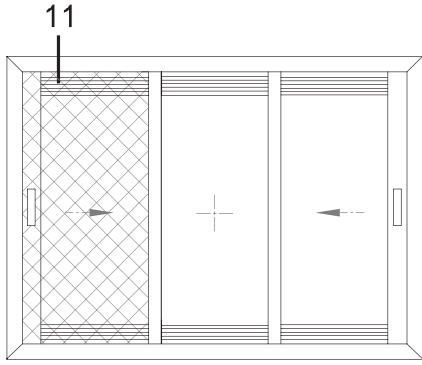

D-11

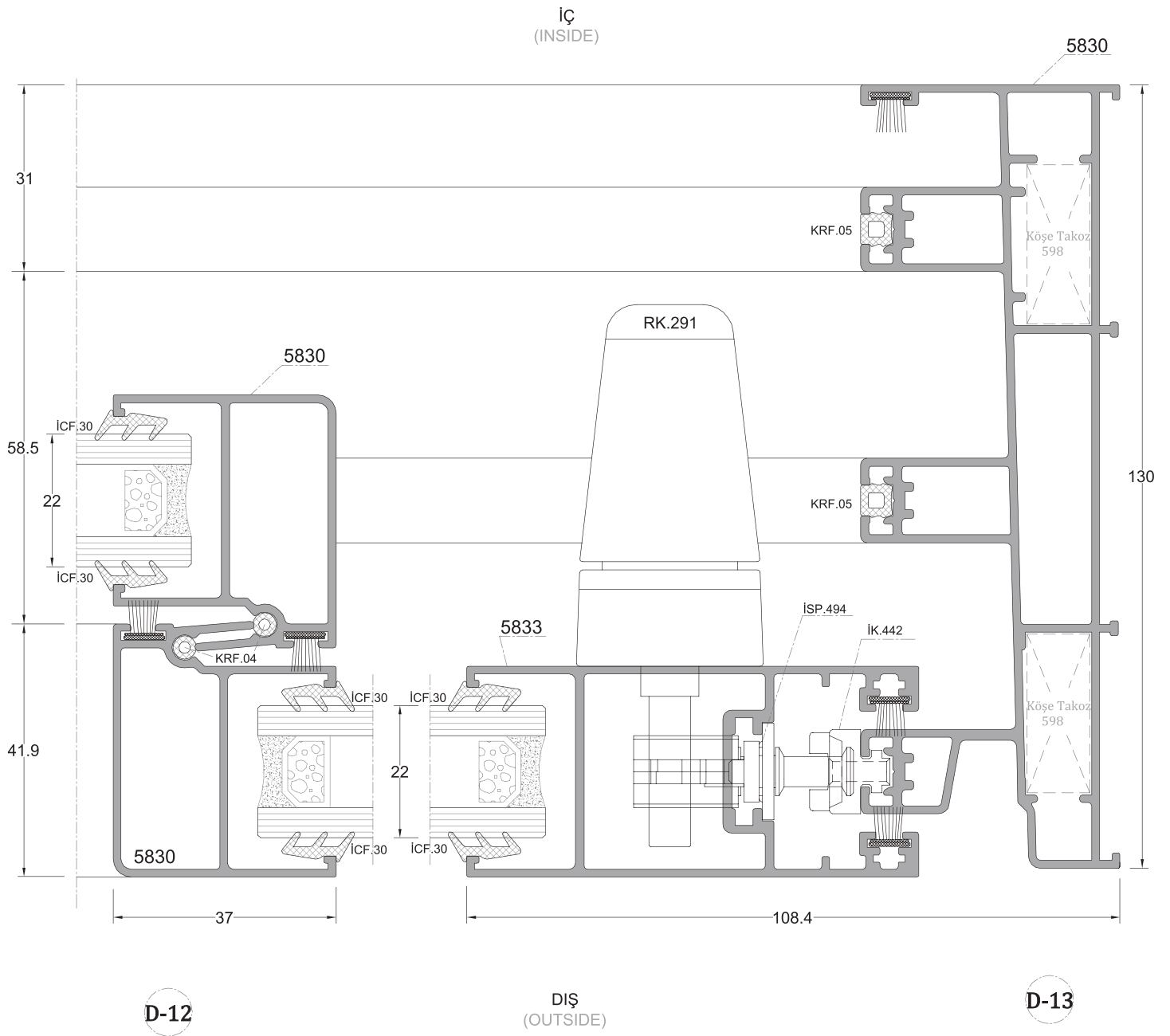
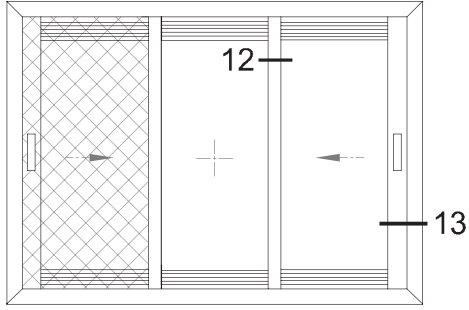

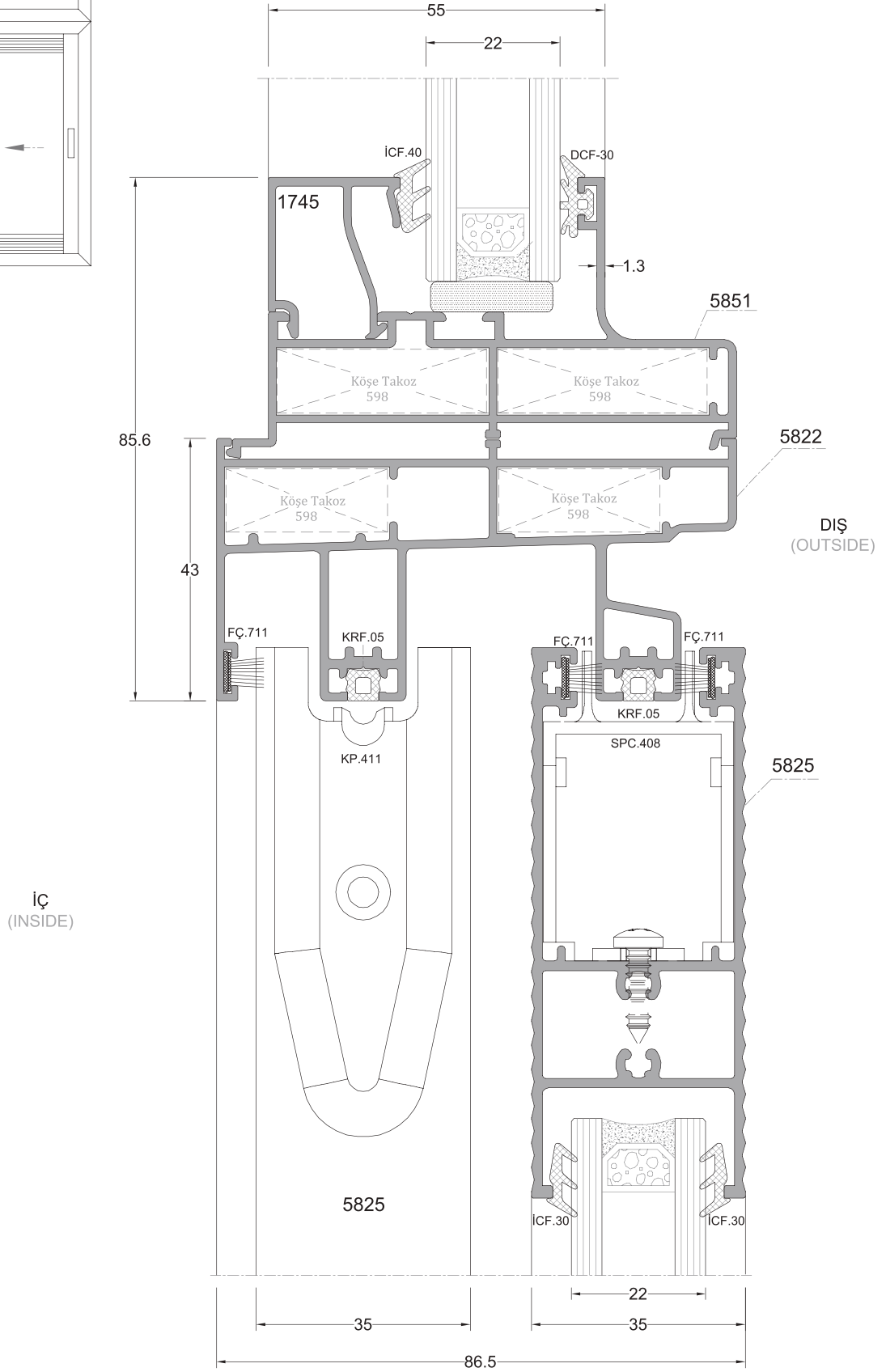
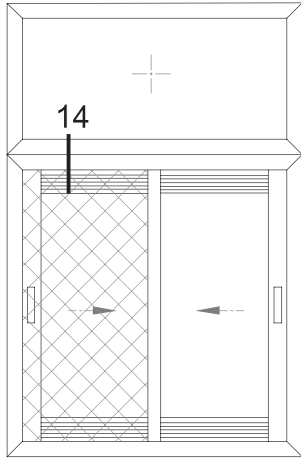

D-14

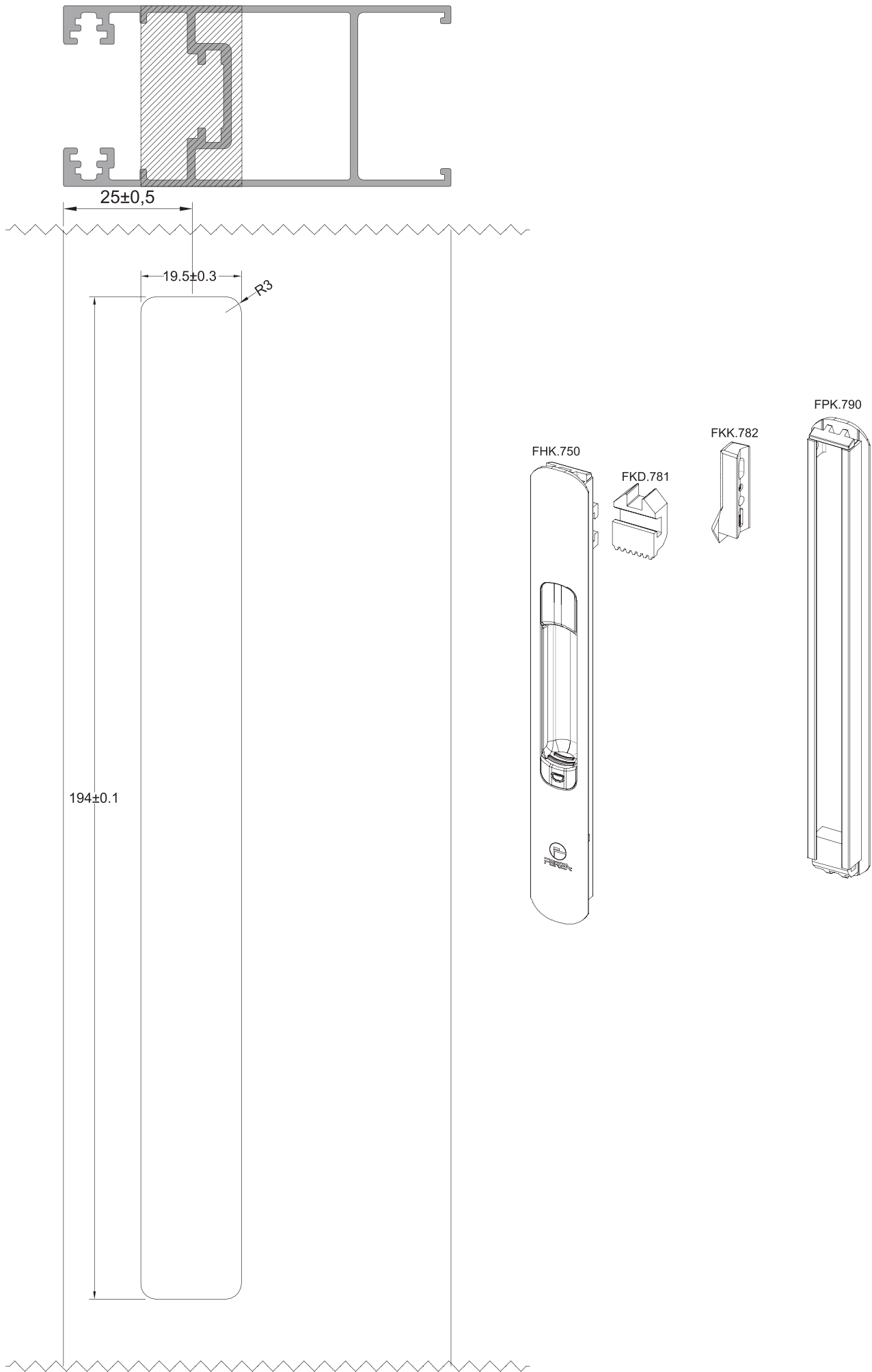

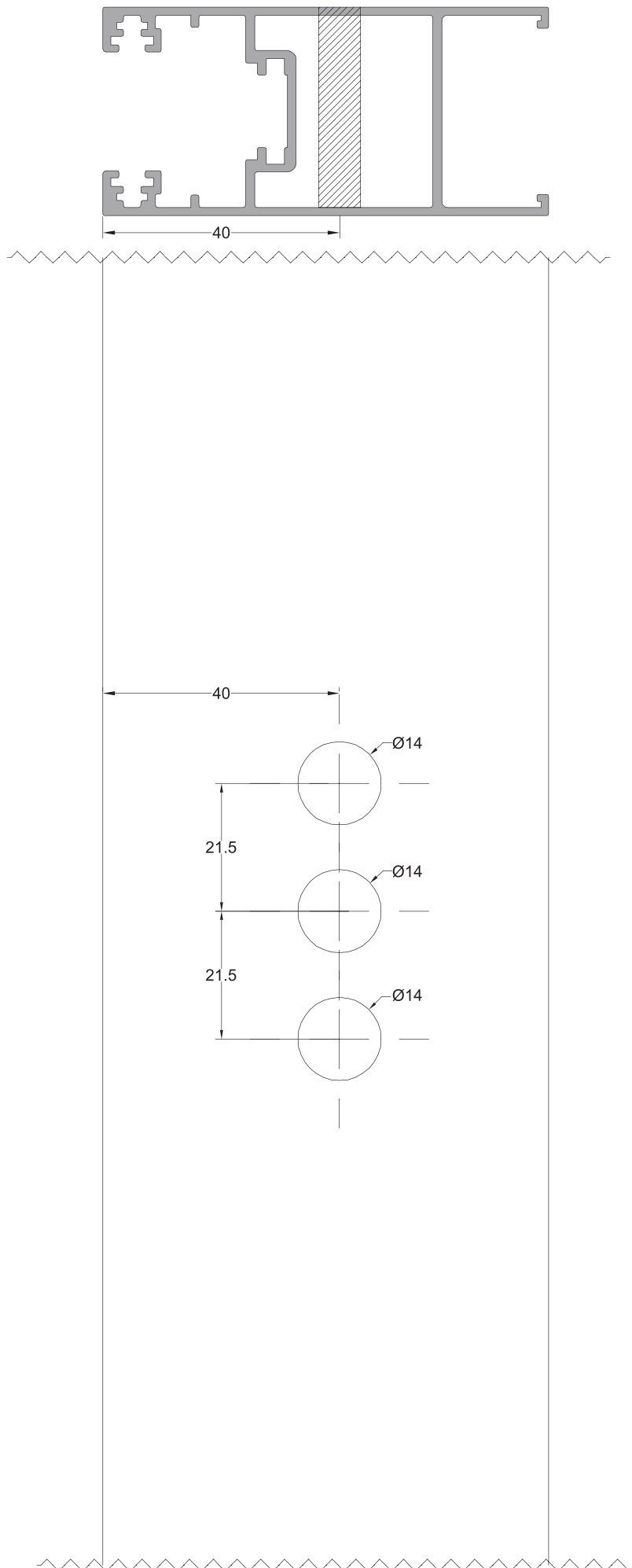

RK.291

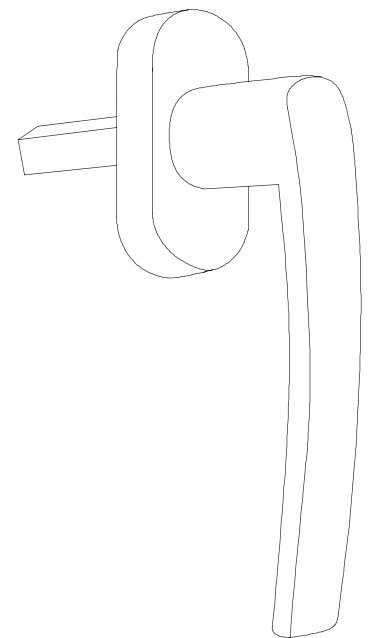

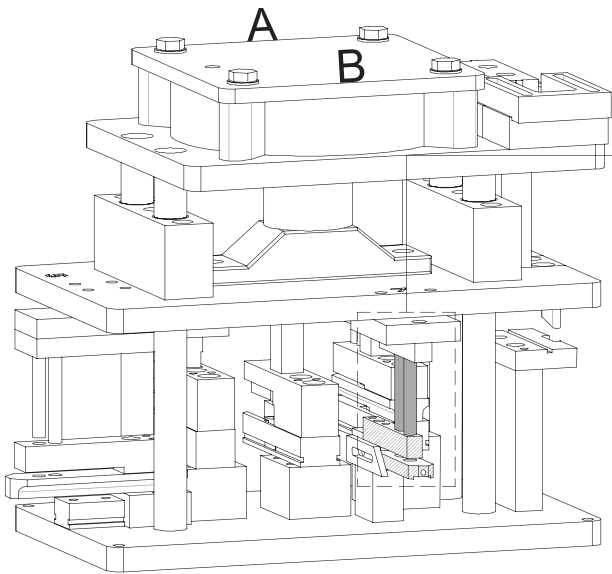

7

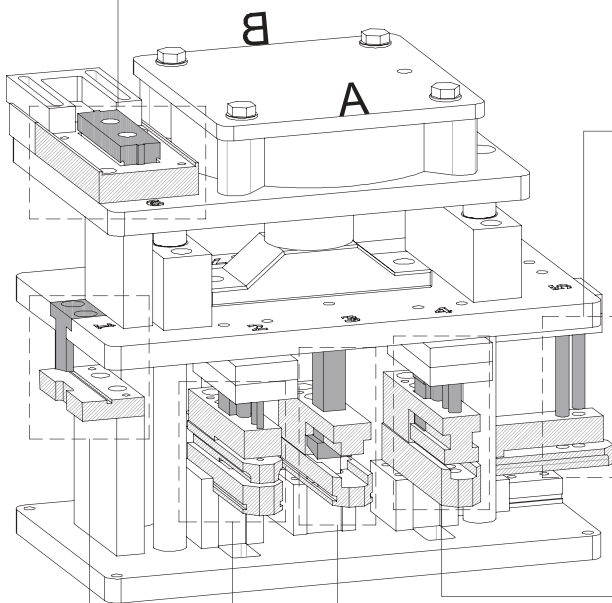
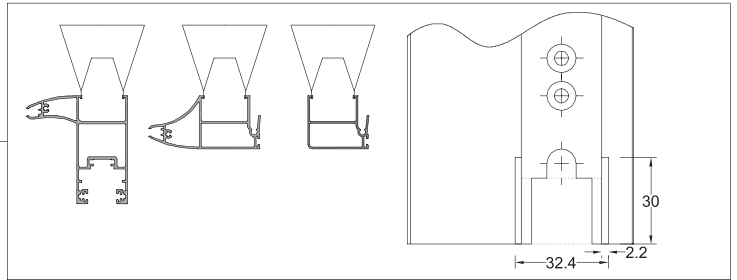

6

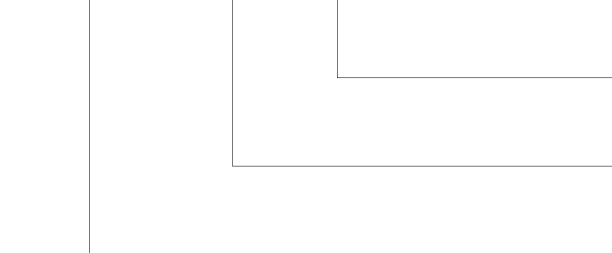
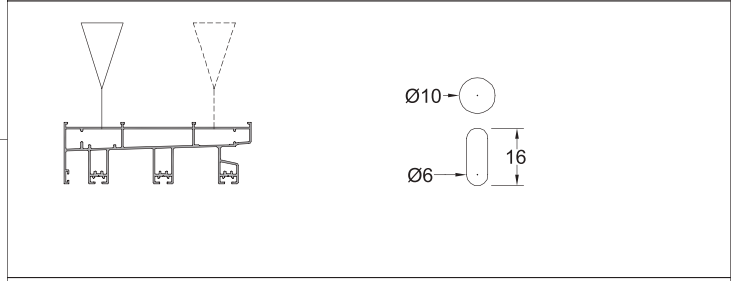

5

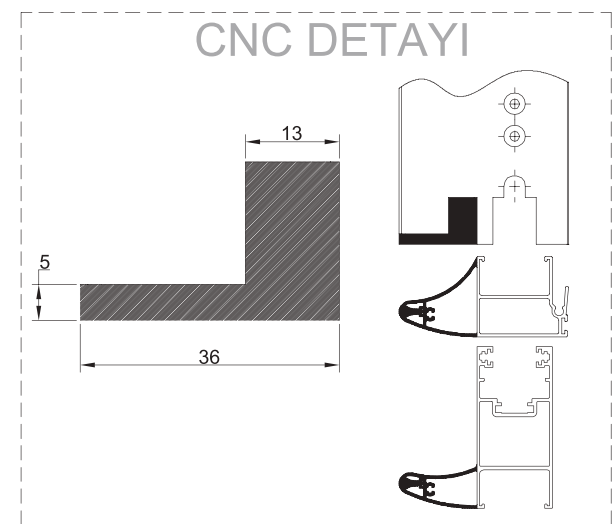
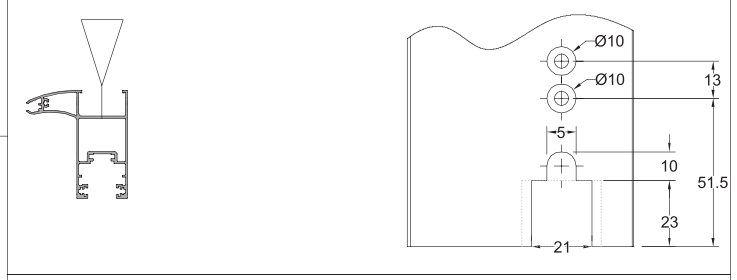

4

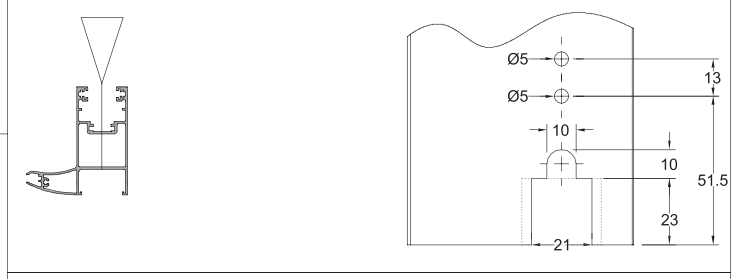

3

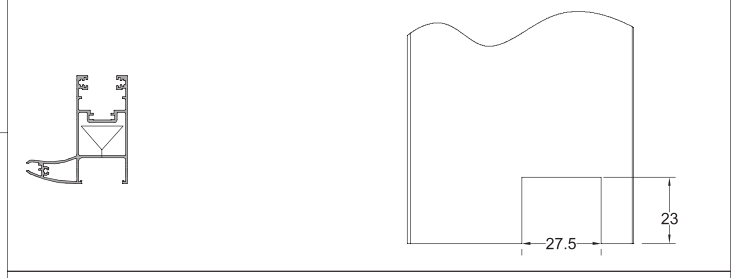

2

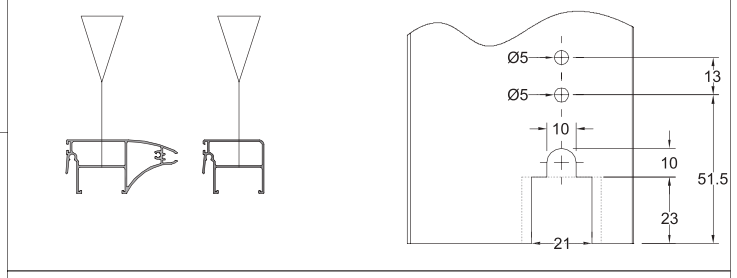

1

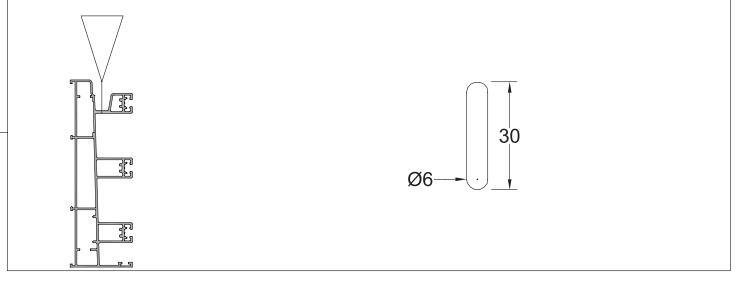

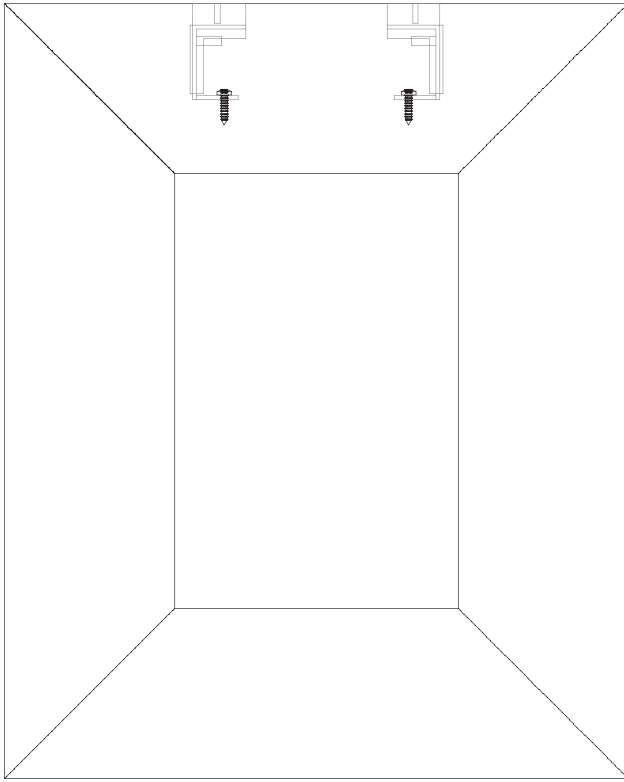

SPC.408

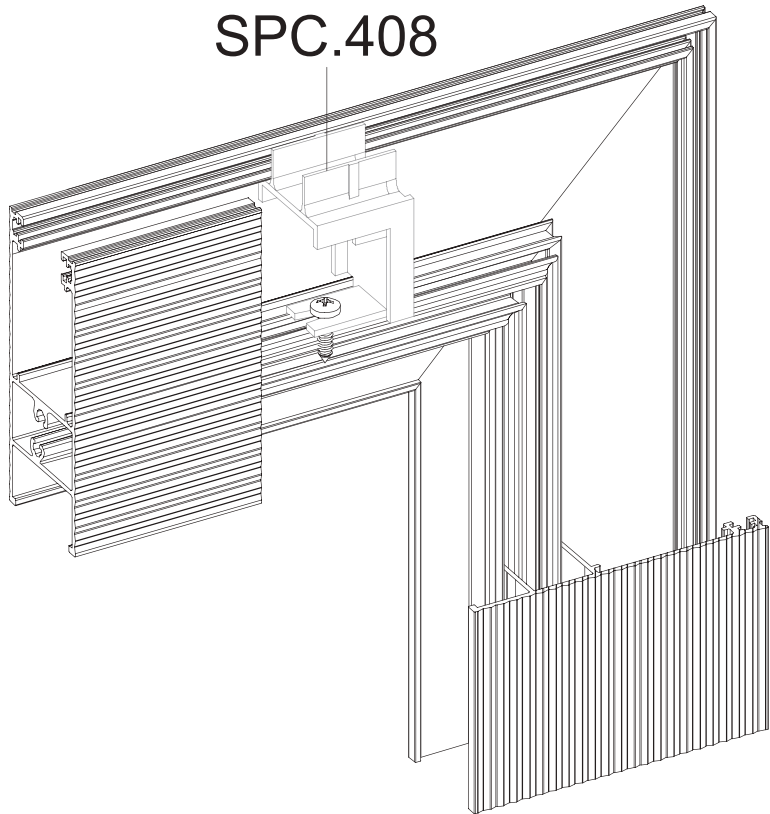

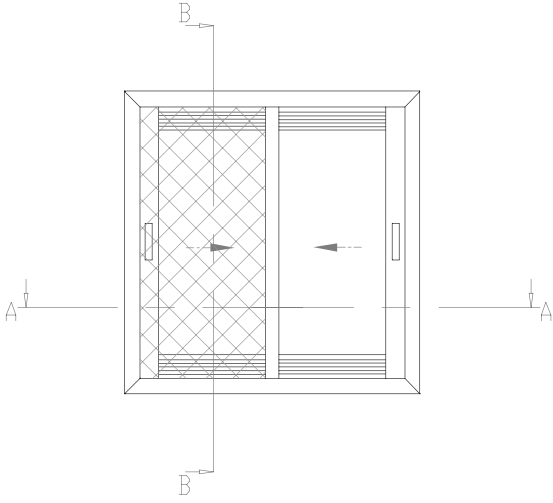

B-B KESİTİ

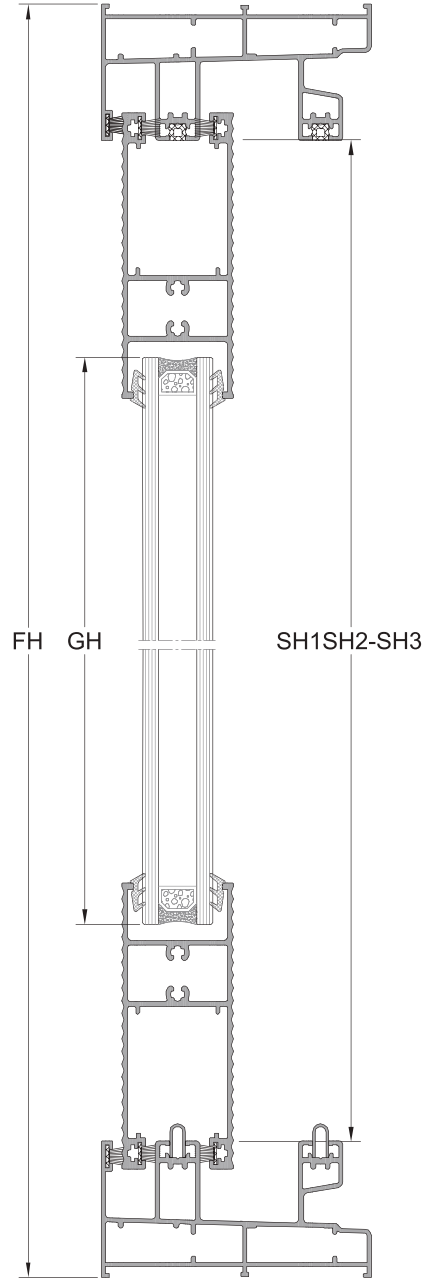

PROFİLLER / PROFILES

Kod Code	Çizim Drawing	Kesim Cut	Miktar Quantity	Ölçüler Dimensions
5822 Kasa Frame			2 Pcs / Adet	FL
			2 Pcs / Adet	FH
5833 Kanat Sash			2Pcs / Adet	SH1= FH-74,4
5830 Kanat Sash			1Pcs / Adet	SH2= FH-74,4
5831 Kanat Sash			1Pcs / Adet	SH3= FH-74,4
5825 Kanat Sash			4Pcs / Adet	SL1= (FL/2)-132

CAM / GLASS

Kod Code	Çizim Drawing	Miktar Quantity	Ölçüler Dimensions
CAM GLASS		2 Pcs / Adet	GL1 = (FL/2)-100
			GH = FH-222

CAM ÖLÇÜLERİ EŞİT KABUL EDİLEREK
FORMULİZE EDİLMİŞTİR.

GLASS DIMENSIONS ARE
FORMULATED, ACCEPT EQUAL.

A-A KESİTİ

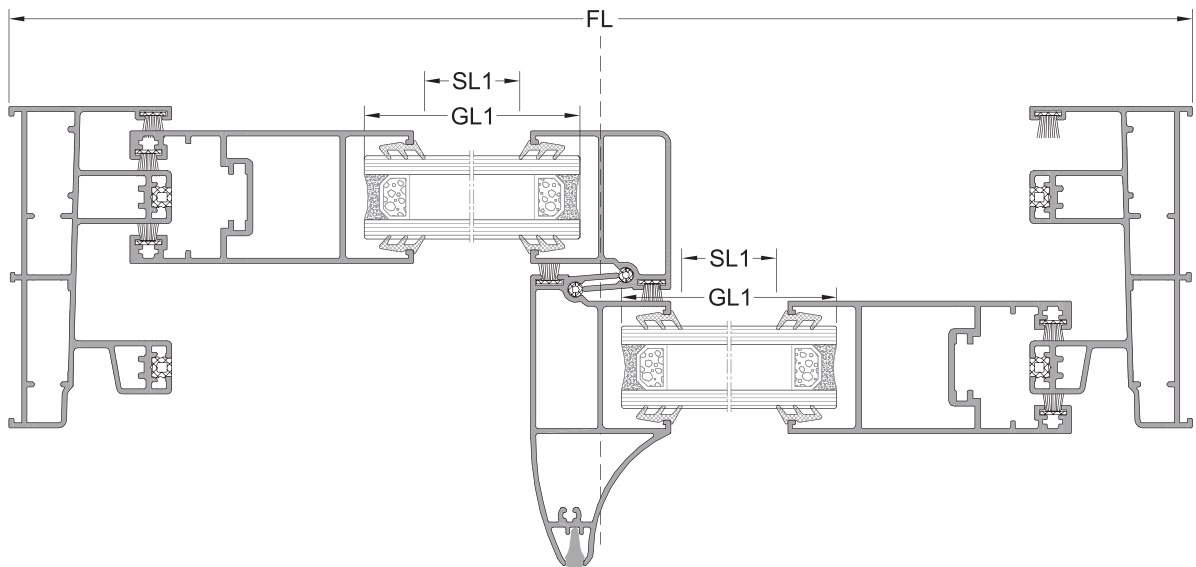

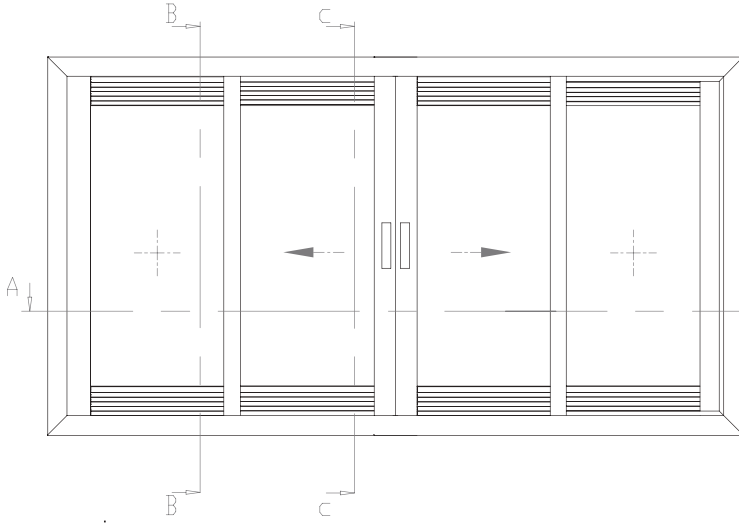

B-B KESİTİ

C-C KESİTİ

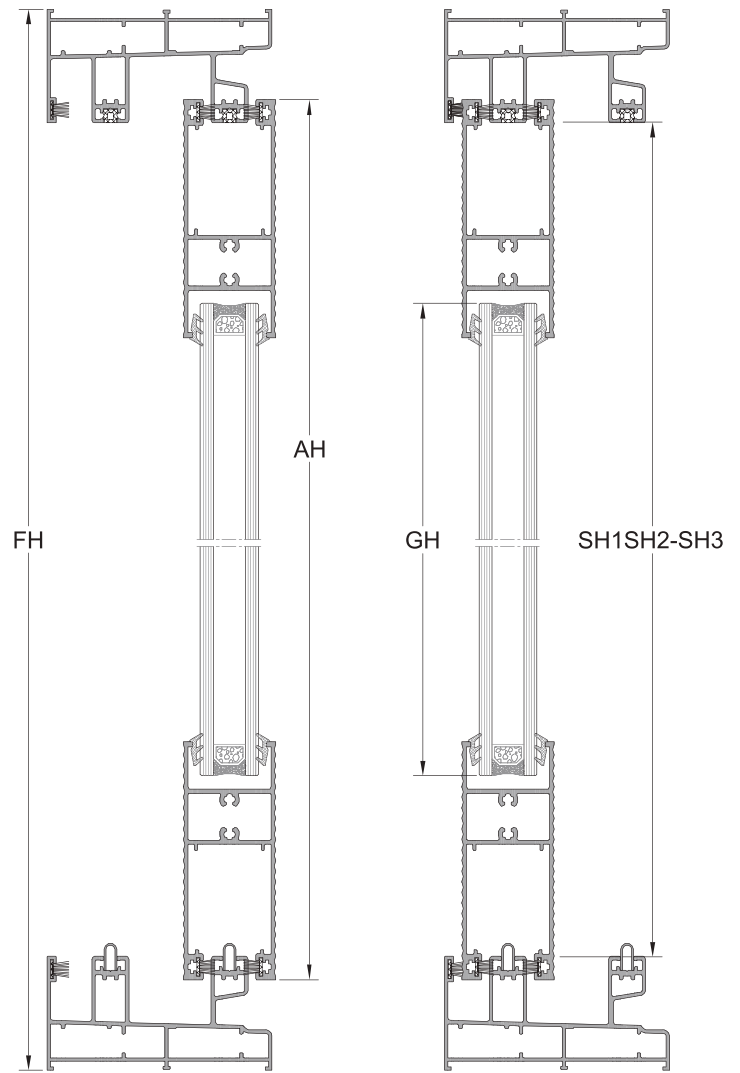

PROFİLLER / PROFILES

Kod Code	Çizim Drawing	Kesim Cut	Miktar Quantity	Ölçüler Dimensions
5822 Kasa Frame			2 Pcs / Adet	FL
			2 Pcs / Adet	FH
5833 Kanat Sash			4Pcs / Adet	SH1= FH-74,4
5830 Kanat Sash			2Pcs / Adet	SH2= FH-74,4
5831 Kanat Sash			2Pcs / Adet	SH3= FH-74,4
5825 Kanat Sash			8Pcs / Adet	SL1= (FL/4)-117
5832 Adaptör Adapter			1Pcs / Adet	AH= FH-95

CAM / GLASS

Kod Code	Çizim Drawing	Miktar Quantity	Ölçüler Dimensions
CAM GLASS		4 Pcs / Adet	GL1 = (FL/4)-85
			GH = FH-222

CAM ÖLÇÜLERİ EŞİT KABUL EDİLEREK
FORMULİZE EDİLMİŞTİR.

GLASS DIMENSIONS ARE
FORMULATED, ACCEPT EQUAL.

A-A KESİTİ

